

CipherLab Reference Manual

Windows Embedded Handheld 6.5

CP50/CP50 G

Version 1.00



PREFACE

COPYRIGHT

Copyright © 2012 CIPHERLAB CO., LTD.

All rights reserved

The information contained in this document, including all pictures, illustrations and software, is the proprietary information of CIPHERLAB CO., LTD. and its respective legal owners; it is protected by copyright laws and international copyright treaties, as well as other intellectual property laws and treaties, with all rights reserved.

In no event and by no part shall this document be reproduced, stored in a retrieval system, or transmitted in any form or by any means including but not limited to electronic, mechanical, photocopying, and recording without the prior written consent of CIPHERLAB CO., LTD. Any reverse engineering of software is also prohibited.

DISCLAIMER

The information herein is subject to change without notice. The information and the intellectual property herein are confidential between you and CIPHERLAB CO., LTD. and remain the exclusive property of CIPHERLAB CO., LTD. and its respective legal owners. Should you find any problems in this document, please report them to CIPHERLAB in writing. CIPHERLAB does not warrant this document is error-free.

TRADEMARK RECOGNITION

CipherLab logo is a registered trademark of CIPHERLAB CO., LTD. Windows Embedded Handheld is a registered trademark or trademark of Microsoft Corporation in the United States and/or other countries. All other brands, products and services, and trademark names are the property of their registered owners. The editorial use of these names is for identification as well as to the benefit of the owners, with no intention of infringement.

CONTACT

For product consultancy and technical support, please contact CIPHERLAB's sales representative in your local area. You may also visit CIPHERLAB web site for more information.

CIPHERLAB CO., LTD.

Website: <http://www.cipherlab.com>

SAFETY NOTICES

FOR HAND-HELD PRODUCT WITH RF FUNCTIONS

CP50/CP50 G serial handheld equipment uses wireless radios that have been designed and manufactured to meet safety requirements for limiting exposure to radio waves. When used in accordance with the instructions set forth in this manual, the equipment has been independently verified to not exceed the emission limits for safe exposure to radio frequency (RF) energy as specified by EN50360 of EEC.

These limits are part of comprehensive guidelines and establish permitted levels of RF energy for the general population. The guidelines are based on standards that were developed by independent scientific organization through periodic and thorough evaluation of scientific studies. The standards include a substantial safety margin designed to assure the safety of all persons, regardless of age and health.

The exposure standard for all wireless devices employs a unit of measurement known as the Specific Absorption Rate, or SAR; the SAR limit set by CE is 2.0W/Kg.

For trunk, the SAR value of CP50/CP50 G serial handheld is:

EEC: MAX 0.335W/Kg (CP50 G), 0.013 (CP50)

FOR PRODUCT WITH LASER



CAUTION

This laser component emits FDA / IEC Class 2 laser light at the exit port. Do not stare into beam.

SAFETY PRECAUTIONS

RISK OF EXPLOSION IF BATTERY IS REPLACED BY AN INCORRECT TYPE. DISPOSE OF USED BATTERIES ACCORDING TO THE INSTRUCTIONS.

- ▶ The use of any batteries or charging devices, which are not originally sold or manufactured by CipherLab, will void your warranty and may cause damage to human body or the product itself.
- ▶ DO NOT disassemble, incinerate or short circuit the battery.
- ▶ DO NOT expose the scanner or the battery to any flammable sources.
- ▶ For green-environment issue, it's important that batteries should be recycled in a proper way.
- ▶ Under no circumstances, internal components are self-serviceable.
- ▶ The charging and communication cradle uses an AC power adapter. A socket outlet shall be installed near the equipment and shall be easily accessible. Make sure there is stable power supply for the mobile computer or its peripherals to operate properly.

CARE & MAINTENANCE

- ▶ This mobile computer is intended for industrial use. The mobile computer is rated IP65, however, the mobile computer can get damaged when being exposed to extreme temperatures or soaked wet.
- ▶ When the enclosure of the mobile computer gets dirty, use a clean and wet cloth to wipe off the dust. DO NOT use/mix any bleach or cleaner. Always keep the LCD dry.
- ▶ For a liquid crystal display (LCD) or touchscreen, use a clean, non-abrasive, lint-free cloth to wipe dust off the screen. DO NOT contact the surface with any pointed or sharp object.
- ▶ If you want to put away the mobile computer for a period of time, download the collected data to a host computer, and then take out the battery pack. Store the mobile computer and battery pack separately.
- ▶ When the mobile computer resumes its work, it takes some time for the main and backup batteries to become fully charged.
- ▶ If you shall find the mobile computer malfunctioning, write down the specific scenario and consult the sales representative in your local area.

DECLARATION OF CONFORMITY - EU

This device complies with the essential requirements of R&TTE Directive 1999/5/EC. The following test methods have been applied in order to prove presumption of conformity with the essential requirements of R&TTE Directive 1999/5/EC:

EN 60950-1: 2006 + A11: 2009

Safety of Information Technology Equipment

EN 300 330-1 V1.7.1: 2006

Electromagnetic compatibility and Radio spectrum Matters (ERM); Short Range Devices (SRD); Radio equipment in the frequency range 9 kHz to 25 MHz and inductive loop systems in the frequency range 9 kHz to 30 MHz; Part 1: Technical characteristics and test methods.

EN 300 330-2 V1.5.1: 2006

Electromagnetic compatibility and Radio spectrum Matters (ERM); Short Range Devices (SRD); Radio equipment in the frequency range 9 kHz to 25 MHz and inductive loop systems in the frequency range 9 kHz to 30 MHz; Part 2: Harmonized EN under article 3.2 of the R&TTE Directive.

EN 300 440-1 V1.6.1: 2010

Electromagnetic compatibility and Radio spectrum Matters (ERM); Short range devices; Radio equipment to be used in the 1 GHz to 40 GHz frequency range; Part1: Technical characteristics and test methods.

EN 300 440-2 V1.4.1: 2010

Electromagnetic compatibility and Radio spectrum Matters (ERM); Short range devices; Radio equipment to be used in the 1 GHz to 40 GHz frequency range; Part 2: Harmonized EN under article 3.2 of R&TTE Directive.

EN 300 328-V1.7.1: 2006

Electromagnetic compatibility and Radio spectrum Matters (ERM); Wideband Transmission systems; Data transmission equipment operating in the 2,4 GHz ISM band and using spread spectrum modulation techniques; Harmonized EN covering essential requirements under article 3.2 of the R&TTE Directive.

EN 301 908-1 V5.2.1: 2011

Electromagnetic compatibility and Radio spectrum Matters (ERM); Base Stations (BS), Repeaters and User Equipment (UE) for IMT-2000 Third-Generation cellular networks; Part 1: Harmonized EN for IMT-2000, introduction and common requirements, covering essential requirements of article 3.2 of the R&TTE Directive.

EN 301 511-V9.0.2: 2003

Global System for Mobile communications (GSM); Harmonized standard for mobile stations in the GSM 900 and DCS 1800 bands covering essential requirements under article 3.2 of the R&TTE directive (1999/5/EC).

EN 301 489-1 V1.8.1: 2008

Electromagnetic compatibility and Radio Spectrum Matters (ERM); ElectroMagnetic Compatibility (EMC) standard for radio equipment and services; Part 1: Common technical requirements.

EN 301 489-3 V1.4.1 2002

Electromagnetic compatibility and Radio Spectrum Matters (ERM); ElectroMagnetic Compatibility (EMC) standard for radio equipment and services; Part 3: Specific conditions for Short-Range Devices (SRD) operating on frequencies between 9 kHz and 40 GHz.

EN 301 489-7 V1.3.1: 2005

ElectroMagnetic compatibility and Radio spectrum Matters (ERM); ElectroMagnetic Compatibility (EMC) standard for radio equipment ad services; Part 7: Specific conditions for mobile and portable radio and ancillary equipment of digital cellular radio telecommunications systems (GSM and DCS).

EN 301 489-17 V2.1.1 2009

Electromagnetic compatibility and Radio spectrum Matters (ERM); ElectroMagnetic Compatibility (EMC) standard for radio equipment and services; Part 17: Specific conditions for 2,4 GHz wideband transmission systems and 5 GHz high performance RLAN equipment.

EN 301 489-24 V1.5.1: 2010

Electromagnetic compatibility and Radio Spectrum Matters (ERM); ElectroMagnetic Compatibility (EMC) standard for radio equipment and services; Part 24: Specific conditions for IMT-2000 CDMA Direct Spread (UTRA) for Mobile and portable (UE) radio and ancillary equipment.

RELEASE NOTES

Version	Date	Notes
1.00	6 th July 2012	Initial

CONTENTS

PREFACE	II
Copyright	ii
Disclaimer	ii
Trademark Recognition.....	ii
Contact	ii
Safety Notices	iii
For Hand-held Product with RF Functions.....	iii
For Product with Laser.....	iii
Safety Precautions	iv
Care & Maintenance	iv
Declaration of Conformity - EU	v
RELEASE NOTES	VII
INTRODUCTION	1
About This Document	1
Features	2
Inside the Package	2
Accessories	2
USE MOBILE COMPUTER	3
Take A Tour	4
Overview	4
Inside Battery Chamber	5
Power On/Off	6
Notifications	7
Battery.....	9
Main Battery Setup	9
Charge Batteries	11
Monitor Battery Level	14
Power Management.....	17
Optimize Battery Life	18
Text Input	19
Physical Keypad	19
Onscreen Keyboard	25
Handwriting Recognition.....	30
Edit Text	32
Touch Control.....	34
Use Touchscreen	34
Screen Orientation	34
Adjust Backlight.....	34
Calibration	35
Memory	37
Data Loss Caution.....	37
Check Storage	37
Insert SD Card	39

Direct Data Connection.....	40
Use Cable	40
Use Cradle	40
Syncing Tools.....	42
Sync Partnership	42
1 st USB Sync	43
Disconnect USB ActiveSync.....	45
ActiveSync Actions to Take.....	46
Charging & Communication Cradle	52
Use Converter	52
Overview	53
Pistol Grip	54
Install Pistol Grip	54
Scan.....	54
Uninstall Pistol Grip	54
Audio Playback	55
Volume Control	55
DATA CAPTURE	57
Launch Reader Module(s)	58
Read Printed Barcodes & RFID Tags	59
Configure Reader(s).....	60
General tabbed page.....	60
Symbolologies Tabbed Page	72
About tabbed page	73
CAMERA.....	75
Launch Camera	76
Camera Screen	76
Take Pictures	77
Camera Settings.....	78
Launch Camcorder	80
Camcorder Screen	80
Shoot Videos	81
Camcorder Settings.....	82
Pictures & Videos.....	84
OPERATING SYSTEM	87
1 st Startup	88
Today Screen	89
Customize Today Screen.....	91
Return to Today Screen.....	91
Start Screen	92
Return to Start screen	93
Title Bar.....	93
Manage Notifications	95
Customize Start Screen	96
Start Screen Icons	99
Suspend & Reset Mobile Computer	102

Suspend Mobile Computer	102
Wake up Mobile Computer	103
Reset Mobile Computer	103
Set Screen Lock.....	105
Unlock Screen	105
Work with Menus	106
Option MenuS.....	106
Context MenuS	107
Manage Applications	108
Task Manager.....	108
RADIOS	115
Access Cellular WAN	116
Status Icons	116
Check What Network You're Using.....	116
Enable/Disalbe Mobile Data	117
Use Only 2G Networks.....	117
Cellular Data Setup.....	118
Edit & Add Access Points	119
USB Internet Sharing	120
Use Wi-Fi	121
Status Icons	121
Enable/Disable Wi-Fi.....	121
Wi-Fi Connection Setup	122
Connect Another Wi-Fi network	126
Edit Wi-Fi Networks	126
Forget Wi-Fi Netowrks	126
Receive notifications of Available networks	126
Add Wi-Fi Networks.....	127
Connect by Static IP.....	128
Advanced Wi-Fi Settings	128
Use Bluetooth.....	130
Status Icons	130
Change Bluetooth name	130
Expose Mobile computer.....	131
Turn on/off Bluetooth	132
Pair & Connect Bluetooth devices.....	132
Disconnect Bluetooth Devices.....	134
Unpair Bluetooth Devices.....	135
ReConnect Bluetooth devices.....	135
Edit Bluetooth Features to Use	135
Bluetooth File Exchange	136
Bluetooth ActiveSync.....	138
Bluetooth Internet Sharing	139
Bluetooth Pass-through Networking.....	140
Connect to Virtual Private Networks	142
VPN Connection Setup	142
Connect VPN.....	144
Disconnect VPN	145
Edit a VPN.....	145

Delete a VPN	146
Install Secure Certificates	147
Supported Certificate Formats.....	147
View Secure Certificates.....	147
Install secure CertificateS	148
Location Discovery	149
Launch GPS & AGPS	149
Use GPS & AGPS.....	150
Use External GPS Receiver with Bluetooth.....	150
Use Secure Access Module	158
Assemble SAM Card	158
Collect Payments	159
PHONE	161
About Phone	162
SIM Card	162
Assemble SIM Card.....	162
Status Icons	163
Phone Ringtone & Vibrate	164
Phone Ringtone	165
Phone Vibrate	166
Phone Ringer Volume.....	166
Place & End Calls.....	167
Open Phone	167
Call History	171
Speed Dial.....	172
Back to Phone Application.....	173
Disable Phone Calls.....	174
Answer or Decline Calls	175
Manage Call History	176
Open Call History	176
Add A Caller to Contacts.....	176
View Caller Screen.....	177
Take Other Actions to A Call Log Entry.....	178
Clear Call History	178
Call Contacts.....	179
Launch Contacts	179
Take Other Actions to A Contact Entry	179
Check Voicemails.....	180
Options during A Call	181
Adjust in-call volume.....	181
Put A Call on/off Hold	182
Mute/Unmute Microphone.....	182
Turn on/off Speakerphone	182
Add A Call.....	183
Other Options	183
Manage Multiple Calls	183
Switch between Two Callers	185
Switch between Bluetooth Headset and Speakerphone	186

Make An Emergency Call	187
MORE APPLICATIONS	189
Backup Utility.....	190
Launch Backup Utility.....	190
Registry Backup and Restoration	191
System Files Backup.....	193
System Files Restoration.....	196
Clone	198
Button Assignment	199
Launch Button Assignment	199
Redefine	199
Recover Defaults.....	201
GPS Viewer	202
Launch GPS Viewer	202
View NMEA-based Data.....	204
Signature Utility	205
Launch Signature Utility	205
Capture Signatures	206
View OR Edit Existing Signatures	206
Preferences.....	207
MANAGE MOBILE COMPUTER.....	209
Update O.S. Image.....	210
USB Upgrade.....	210
SD Card Auto Update	212
SD Card Manual Update	214
System Settings.....	216
Connections Folder	219
Personal Folder	225
System Folder	226
SPECIFICATIONS	231
Platform, Processor & Memory	231
Communications & Data Capture	231
Electrical Characteristics	232
Physical Characteristics	232
Environmental Characteristics	233
Programming Support.....	233
Accessories.....	234
SCAN ENGINE SETTINGS.....	235
Symbologies Supported.....	236
RFID Tags Supported	238
LASER (SE955).....	239
Symbology Settings.....	239
Miscellaneous.....	242
AIM Code ID - Code Characters	242
AIM Code ID - Modifier Characters.....	243

- 2D IMAGER (SE4500DL) 247**
 - Symbology Settings..... 247
 - 1D Symbologies..... 247
 - 2D Symbologies..... 253
 - Miscellaneous..... 255
- HF RFID READER..... 257**
 - RFID Tag Default Block 257
- PHYSICAL KEYPAD REFERENCE TABLE 259**
 - Numeric Keypad 259
 - Use Alpha (α), Shift (⇧) & Fn Keys..... 259
 - QWERTY Keypad..... 261
 - Use Alpha (α), Shift (⇧) & fN KEYS..... 261

INTRODUCTION

Thank you for choosing CipherLab products. CipherLab welcomes another Windows Embedded by introducing CP50 Series Mobile Computer. Powered by Windows Embedded Handheld 6.5, the mobile computer delivers better user experience and promises enterprise mobile computing.

The mobile computer has transfective LCD to hold up the readability in a wide range of light conditions, courtesy of the supplementary backlight enabled by a built-in ambient light sensor. Also on board is a G-sensor to save power according to the mobile computer's motion and posture. G-sensor also enables screen orientation when the device poses sideways or upright. Security Access Modules (SAM) on the other hand favors the mobile computer with payment applications.

The series sports satisfactory data connections by integrating a communication port for direct data exchange. For wireless data connections it hosts each Bluetooth and 802.11b/g module while a 3.75G module is provided on option.

Due to the built-in GPS receiver, Assisted-GPS is possible if 3.75G data is available on the mobile computer. AGPS accelerates positioning even without a clear view of the sky given a location-aware application to work with.

Dedicated to data capture, the mobile computer has essential 1D (laser) reader or 2D imager plus RFID scan engine. A high-specced 5 mega-pixel camera also comes inside to take pictures and shoot videos to deliver better documentation for users.

Rated with IP65, the rugged CP50 is light-weighted and easy to cradle in your hand, and will be your good help on field works.

ABOUT THIS DOCUMENT

This guide distills the information about CP50 Series Mobile Computer. Subjects discussed include the mobile computer's physical features, platform basics, software and applications, and part of the accessories to boost the mobile computer's performance.

We recommend that you keep one copy of this manual at hand for the quick reference for necessary maintenance.

FEATURES

- ▶ Rugged yet smoothened outlined, with hand strap for secure hold
- ▶ IP65-rated tough form to survive drop, shock, heat, cold, and impervious to moisture/dust.
- ▶ Windows Embedded Handheld 6.5 OS, 800 MHz SAMSUNG S3C6410 CPU
- ▶ 256MB SDRAM to run application programs
- ▶ 2GB NAND flash to store OS, applications, settings and so on.
- ▶ Storage expansion: 256MB to 4GB MicroSD and 4GB to 32GB MicroSDHC.
- ▶ OS upgradable with external SD card
- ▶ Sunlight-readable screen to enhance the viewability of outdoor use.
- ▶ Ambient light sensor to enable supplementary backlight for LCD and keypad.
- ▶ G-sensor for power management and screen orientation.
- ▶ 2 symmetric side-triggers for ambidextrous scanning
- ▶ Total data solution — supporting Bluetooth, 802.11b/g and HSPA+
- ▶ Security Access Module for payment-related applications
- ▶ Built-in GPS receiver to deliver location discovery
- ▶ A-GPS and E911 (CP50 G only)
- ▶ 5 mega-pixel camera for taking pictures and shooting videos.
- ▶ C++ and .Net programming support

INSIDE THE PACKAGE

The mobile computer ships with the following items. Save the box and packaging material in case of future need to store or deliver the mobile computer.

- ▶ Mobile Computer
- ▶ Rechargeable Li-ion battery pack
- ▶ Universal power adapter
- ▶ USB Charging & Communication Cable
- ▶ Stylus
- ▶ Product CD
- ▶ LCD protective film
- ▶ Quick Start Guide
- ▶ Hand strap

ACCESSORIES

Optional accessories to enhance the mobile computer's performance:

- ▶ Pistol Grip
- ▶ USB Cable
- ▶ Hand Strap
- ▶ Belt Holster with Shoulder Strap
- ▶ Protective Cover
- ▶ Charging & Communication Cradle with a spare battery
- ▶ Vehicle Mount
- ▶ Vehicle Charger
- ▶ 4-slot Gang Charger

USE MOBILE COMPUTER

Before the mobile computer takes part in your work, get to know it first. This chapter combs the basic features of the mobile computer including the power supply, memory, and the units that bridge users with the mobile computer. This chapter helps you set the mobile computer to work at the earliest.

IN THIS CHAPTER

Take A Tour	4
Power On/Off	6
Battery.....	9
Text Input	19
Touch Control	34
Memory.....	37
Direct Data Connection	40
Charging & Communication Cradle.....	52
Audio Playback.....	55

TAKE A TOUR

This section shows the major components on the mobile computer and inside battery chamber. You will also learn how to power on/off the mobile computer and how the mobile computer gives information about its status.

OVERVIEW

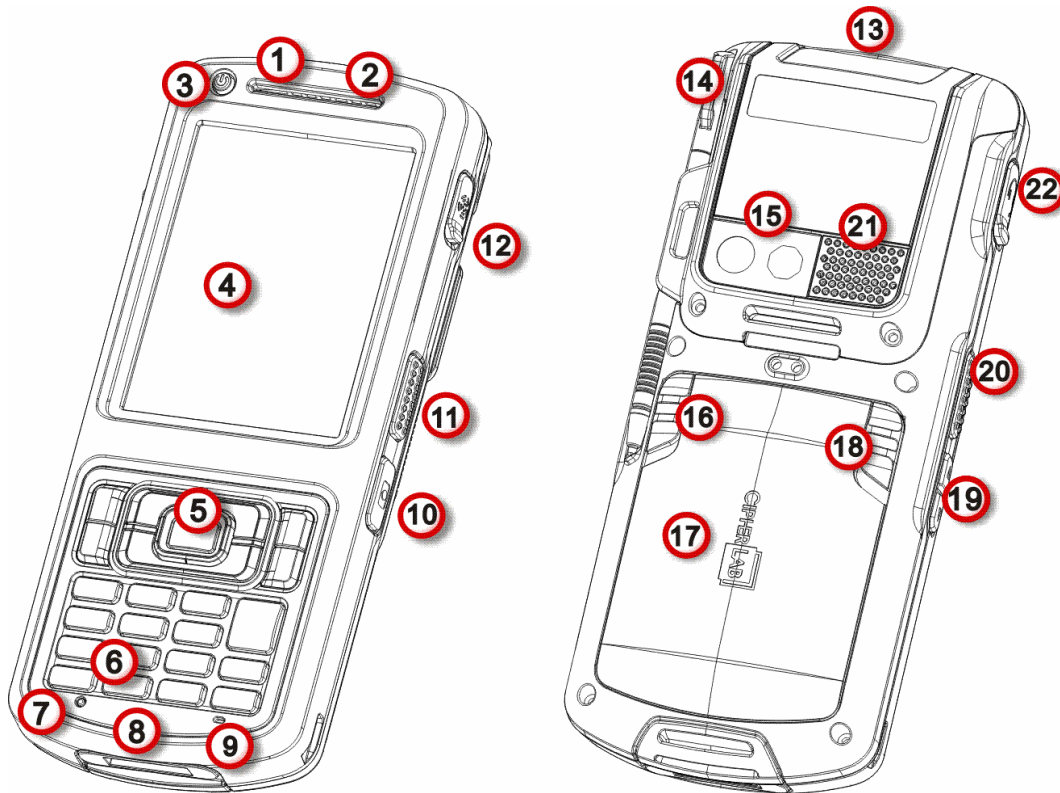

Figure 1: Overview

No.	Description	No.	Description
1	Status LED	2	Receiver
3	Power key	4	Touchscreen (QVGA)
5	Scan key	6	Keypad
7	Reset toggle (recessed in a cutout)	8	Direct charging- & communication-port
9	Microphone	10	Camera shutter button
11	Side-trigger (user definable)	12	External GPS antenna MMCX connector (sealed with an attached & hinged rubber)
13	Scan window	14	Stylus
15	Camera	16	Battery lock
17	Battery door	18	Battery release (spring loaded)
19	Volume rocker	20	Side-trigger (user definable)
21	Speaker	22	Headset jack (sealed with an attached and hinged rubber)

INSIDE BATTERY CHAMBER

Inside battery chamber are the sockets for SIM card, SAM card and storage card. Each is equipped with a hinged cover.

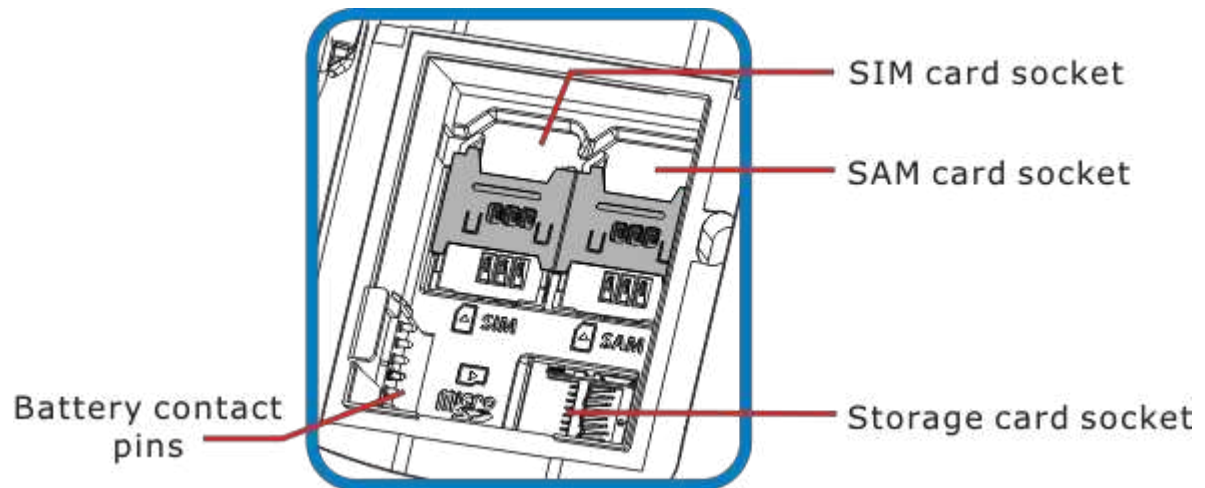



Figure 2: Inside Battery Chamber

POWER ON/OFF

To power on/off the mobile computer, press and hold the Power button  sitting above the upper-left of touchscreen.

When powering off, the O.S. shows a screen that prompts to keep holding the Power button until the mobile computer turns off. (See also [Reset Mobile Computer.](#))

The power-off here is a "hard-off" by turning off the power supply to hardware. See also [Reset Mobile Computer.](#)

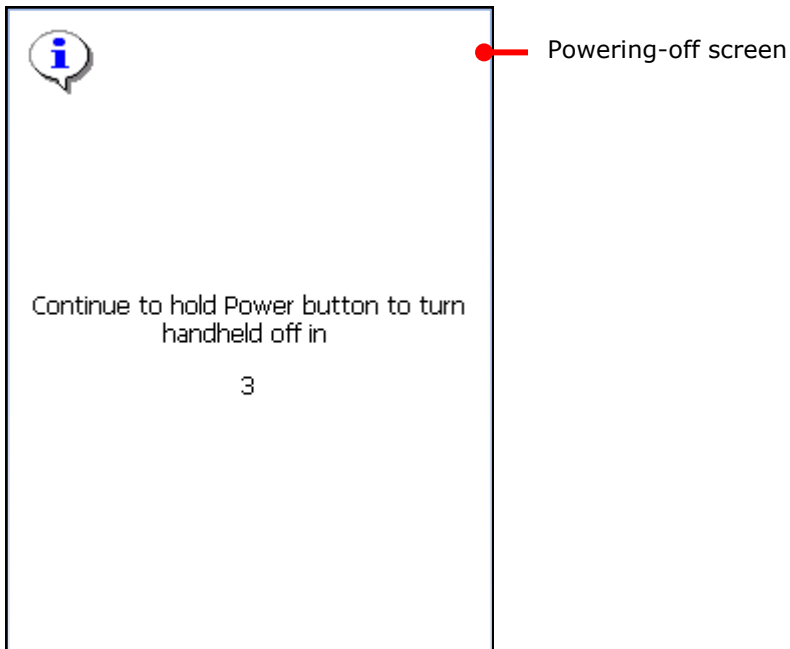

This Power button is also a suspend button, press without holding it to suspend the mobile computer when you are not actively using it. See also [Reset Mobile Computer.](#)

NOTIFICATIONS

The mobile computer features visible, audible, and tactile feedback to draw users' prompt awareness of the mobile computer's contiguous events such as barcode reading, wireless/mobile data connections, and battery charging.

STATUS LED

A triple-color LED light is recessed up front the mobile computer to communicate the mobile computer's statuses as below:

Matter	LED Color	Action	Description
Battery	Red & Green	Green on	Battery is fully charged.
		Red. Slow blinking	Charging ongoing.
		Red. Fast blinking	Charging error that may be caused by temperature dropping below 0°C or exceeding 40°C. See also Charge Batteries .
		Red. Fast blinking twice, then off	Power-on error. The mobile computer cannot power on when either of the following happens: <ul style="list-style-type: none"> ▶ Main battery drops under 7% and over 1%. ▶ Battery is absent but external power is connected (by power adapter). ▶ Battery is present (with power more than 1%) but battery door isn't in place. See also Main Battery Setup.
Scanning Good Read	Green	On for 2 seconds, then off	Enable/disable this notification by the bundled utility <i>ReaderConfigMobile.exe</i> . See the setting at Notifications .
Radios	Blue	Aptly blinking	Wi-Fi, Bluetooth or mobile data in use

LED light is also programmable. See the API library that is readied for your reference.

SPEAKER

The mobile computer has a speaker on the rear for audio signaling, audio playback, and phone ringtones.

The speaker sounds for system events, application warnings, onscreen items selections and stroke on physical keypad as per [Sounds & Notifications](#) setting. In noisy environment, the speaker remains efficacious with the help of a headset. To control sound volume, see [Volume Control](#).

The speaker also sounds for good barcode reading, which can be enabled/disabled by CipherLab's *ReaderConfigMobile.exe*. See [Notifications](#) for setting.

VIBRATOR

The mobile computer owes the tactile feedback to the vibrator built inside. The vibrator applies vibration to users to alert them of the mobile computer's status.

Working based on user's sense, the vibrator is particularly helpful when the mobile computer is serving in noisy environment.

Same as the speaker and LED light, the vibrator works for good barcode reading. CipherLab's utility *ReaderConfigMobile.exe* enables users to turn the vibration on/off and decides the duration. See [Notifications](#).

The vibrator is also programmable. See the API library that is provided for your reference.

BATTERY

The mobile computer is fed by two batteries, main battery pack and backup battery. Main battery is removable and replaceable from battery chamber while backup battery is mounted on the main board inside the mobile computer.

When the mobile computer ships, main battery isn't installed but stored in a separate package, which keeps it in good condition for future use.

MAIN BATTERY

Main battery is a 3.7V / 3300 mAh Li-ion battery pack to be put inside battery chamber. Typically it takes about 4 hours to charge the main battery to full. The working time of the mobile computer varies by its working states. Under normally operation, it works for up to 10 hours. An icon on [Title Bar](#) helps monitor main battery level. See [Main Battery](#) .

See also [Main Battery Setup](#) for the assembly.

BACKUP BATTERY

Backup battery settles on the main board inside the mobile computer. It is a 25 mAh rechargeable Lithium type. When main battery is absent or depleted, backup battery takes over to feed the mobile computer. Without main battery, a fully charged backup battery retains the data in the DRAM and holds the system in suspension for 30 minutes.

Backup battery is rechargeable by the external power (through power adapter) or main battery pack. It takes about 8 hours to charge it to full. An  icon on the [Title Bar](#) makes it observant that backup battery gets low. See also [Backup Battery Level](#).

Note: To power on the mobile computer, the battery door must be installed in place. If not, the status LED will blink red twice and go off to alert to failure to power on the mobile computer. See also [Status LED](#).

MAIN BATTERY SETUP

To secure main battery in place, the battery door is equipped with two latches, battery lock and battery release. Battery lock needs to be manually closed while battery release is spring-loaded and closes automatically.

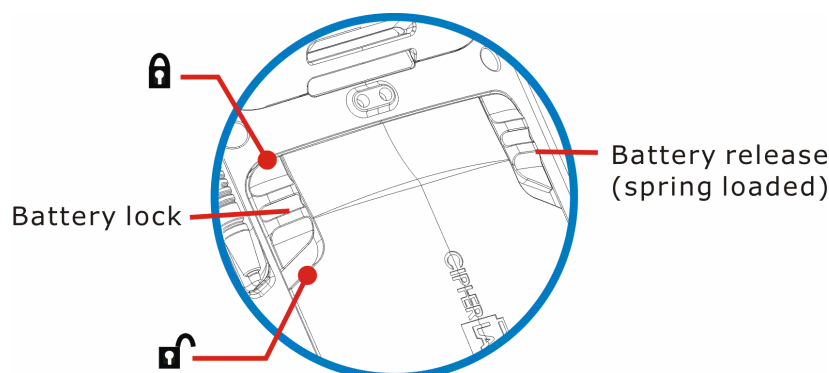

Figure 3: Battery Door Latches

To install main battery pack, follow through the steps below by referencing to the illustration:

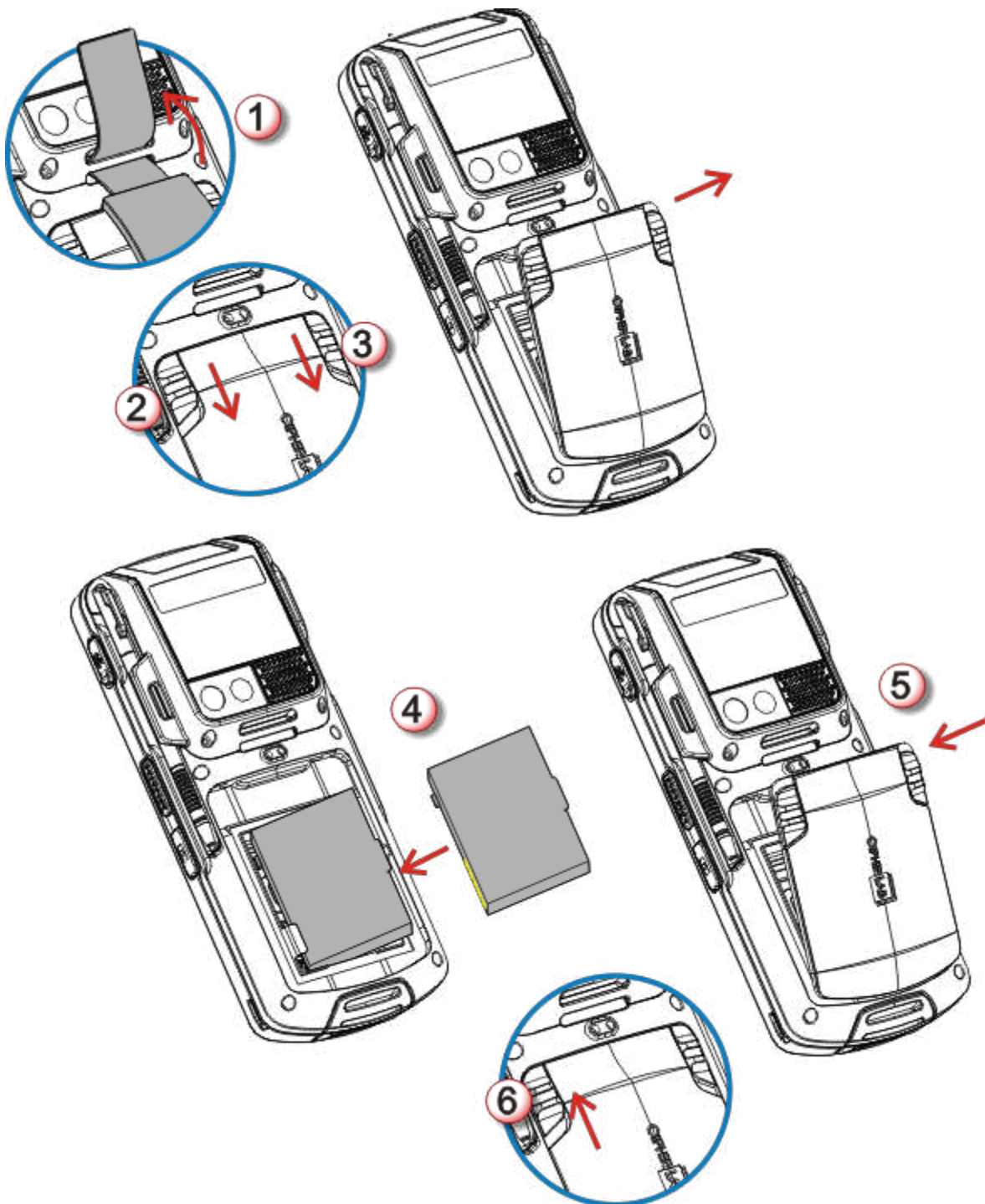

Figure 4: Main Battery Setup

- 1) Remove hand strap.
- 2) Push battery lock to unlock position.
- 3) Push back battery release, which is spring-loaded.

Battery door opens automatically. Detach battery door to reveal battery chamber.

- 4) Have main battery pack. Position and fit it into battery chamber by meeting its edge connectors with the contact pins inside chamber.
- 5) Click battery door back in place.
- 6) Push battery lock to lock position.

Note: (1) Any improper handling may reduce battery life.
(2) When main battery level drops to low level, charge it ASAP or replace it with a charged one.
(3) Always turn off the mobile computer to replace main battery pack.

CHARGE BATTERIES

Due to shipment, it is likely main battery and backup battery aren't fully charged when you receive the package. Before setting the mobile computer to work, charge main battery to full by direct charging using power adapter (with the help of a USB Charging & Communication Cable or Cradle).

Since main battery is the only source backup battery taps power from, be sure to install main battery for the 1st charge so both main battery and backup battery get charged.

Some key facts about charging batteries:

Charging Time

- ▶ **Main battery:** It takes circa 4 hours to charge main battery to full (direct charging with power adapter). The status LED above the touchscreen slowly blinks red during charging, and lights green and stays on when fully charged.
- ▶ **Backup battery:** Backup battery is rechargeable by both main battery and power adapter. It takes about 8 hours to charge it to full. Besides it needs not to be fully charged for the mobile computer to work.

Charging Temperature

- ▶ It is recommended that batteries be charged at room temperature (18°C~25°C) for optimal performance.
- ▶ Charging stops when temperature drops below 0°C or exceeds 40°C.

Power Consumption

- ▶ When all radios (802.11b/g, Bluetooth, mobile data (HSPA+), GPS) are active on battery power, main battery drops substantially.
- ▶ In order to prevent system from shutting down due to depleted main battery, we suggest that you keep a fresh battery for replacement or have the mobile computer access the radios on external power.

The following guides how to charge batteries.

DIRECT CHARGING USING CABLE

Direct charging the mobile computer relies on the USB Charging & Communication Cable (hereinafter "USB cable") included in the package. There is a power jack on the connector of this USB cable to tap external power.

Before start charging, install main battery as described in [Main Battery Setup](#). Then follow through the steps below:

- 1) Lock up USB cable to the mobile computer.
- 2) Have the power adapter. Plug its power cord to the power jack on USB cable's connector.
- 3) Connect power adapter's wall-wart plug to a power outlet.

To output data to your PC or laptop, connect USB cable to it. See [Direct Data Connection](#) for follow-ups.

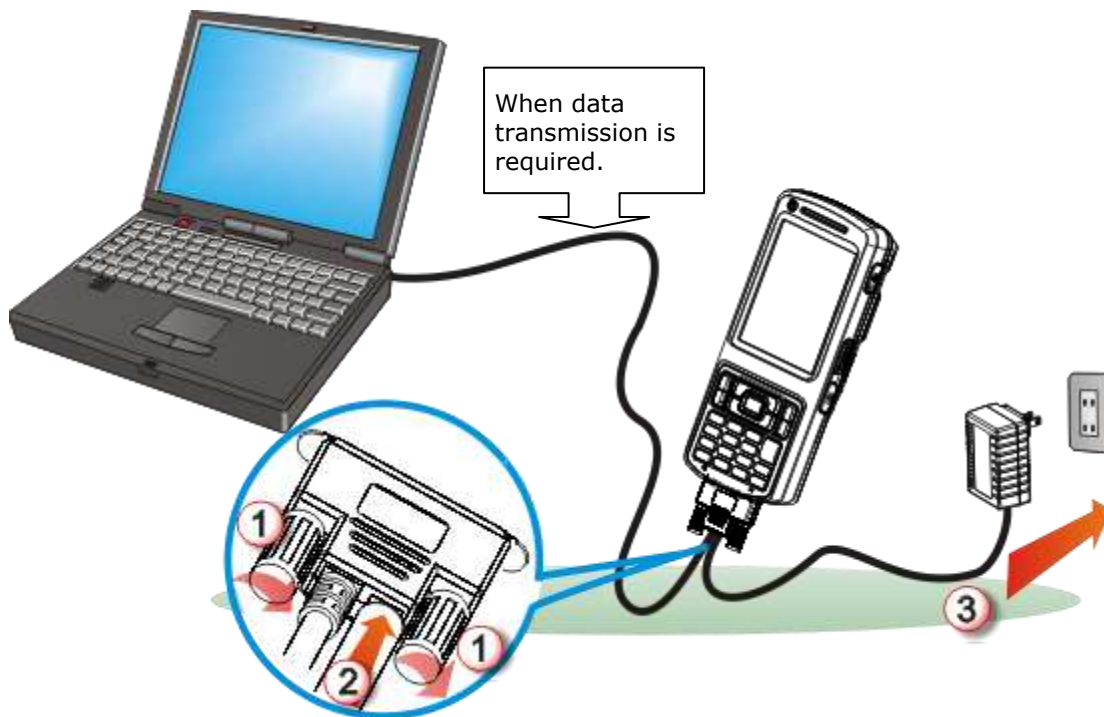

Figure 5: Direct Charging Using Cable

DIRECT CHARGING USING CRADLE

Direct cradle charging makes use of a Charging & Communication Cradle (hereinafter "cradle"). Cradle is one of the accessories you can opt for.

Before start charging, install main battery as described in [Main Battery Setup](#). Then follow through the steps below:

- 1) Seat the mobile computer into cradle.
- 2) Connect cradle to an external power source using power adapter.

To output data to your PC or laptop, connect two devices with USB cable. See [Direct Data Connection](#) for follow-ups.

Note: When the mobile computer is charged through cradle, and USB cable is also connected for data, the power jack on USB cable's connector is inefficacious.

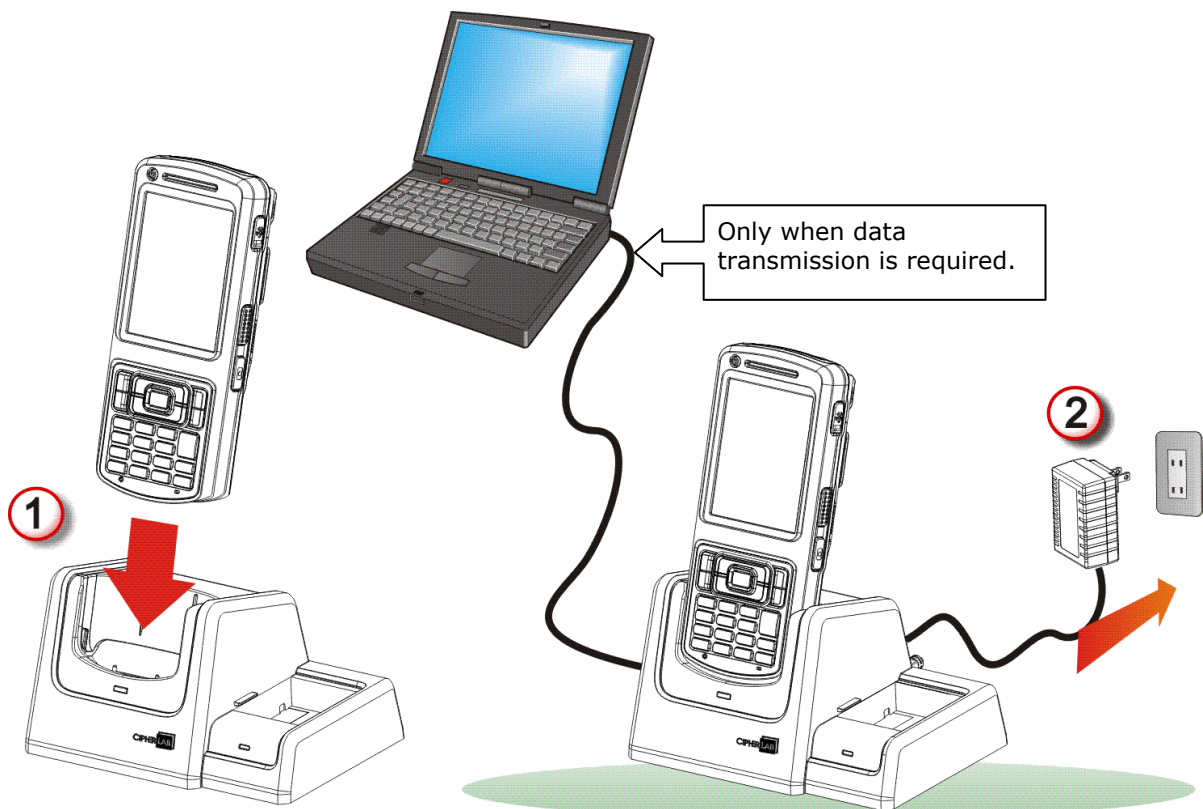

Figure 6: Direct Charging Using Cradle

MONITOR BATTERY LEVEL

Main battery is the only source that feeds the mobile computer to work. It also supplies the backup battery on main board to hold the data stored in DRAM. Hence when main battery gets low, recharge it or change it as soon as possible. But foremost, back up the important data from time to time to protect your work.

MAIN BATTERY LEVEL

The O.S. features a few icons for user's immediate awareness of main battery level. These icons avail themselves of [Title Bar](#) to show. [Title Bar](#) settles at the top of almost every screen.

STATUS ICONS

Main battery icons communicate the following statuses:

Icon	Battery Status
	Main battery is getting charged from external power.
	Main battery reaches 80% to full.
	Main battery partially drains between 60%-79%.
	Main battery drops between 40%-59%.
	Main battery drops between 20%-39%. O.S. prompts for recharge.
	Main battery drops under 7%. Battery needs charging immediately.

MORE CHARGE INFO

To know more about main battery level:

- 1) Tap Windows icon  on [Softkey bar](#) or hit physical Windows key . Start screen opens.

- 2) Tap **Settings | System | Power** .

Power application opens showing Battery tabbed page. The page shows a horizontal bar to enable user's quick grasp of battery's contiguous power amount with a glance.

When main battery isn't being charged, the page auto-rates the remaining power with percentage. However when main battery is being charged, the page doesn't show percentage-amount but "charging" state only. However the horizontal graphic bar encapsulates the remaining power amount whether main battery is being charged or not.

Main battery isn't being charged.

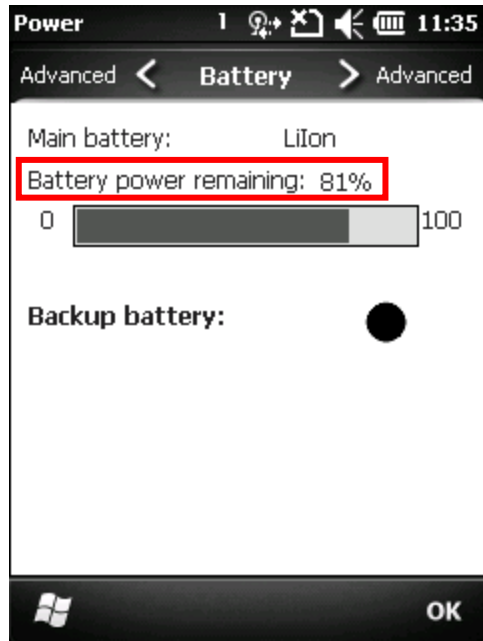

Power amount delivered in percentage enables more accuracy.

Main battery is being charged.

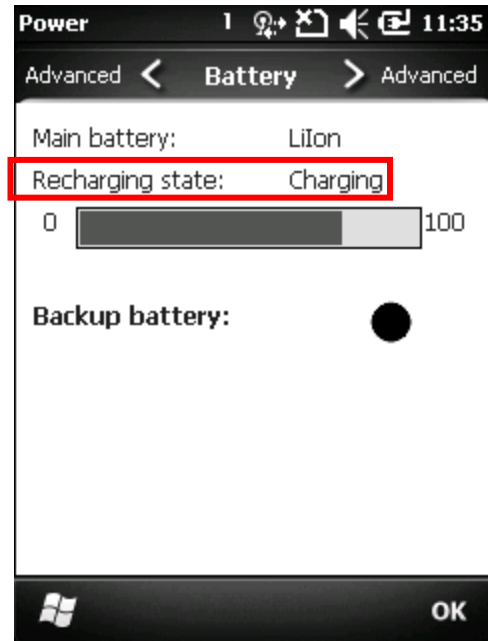

The horizontal graphic bar shows coarse power amount.

LOW BATTERY ALERTS

When main battery level drops below 40% , the mobile computer prompts "Main Battery Low" for a recharge. When further sucked under 20%, the mobile computer prompts "Main Battery Very low" to solicit your immediate transaction.



 Main Battery Very Low prompt

Low battery may incur shutdown to the mobile computer and threats DRAM data. Always save data before running short of power or keep a fresh battery at hand for replacement.

Once battery level drops under 7% (no more than 6.9%), the mobile computer enters suspension and cannot be awoken unless 7% is regained. If you try to wake up the mobile computer by pressing Power button under such circumstances, it doesn't at all and LED light blinks to alert.

Note: There are other cases when the mobile computer cannot be awoken:

- (1) When battery door isn't installed in place.
- (2) Imperfect contact between main battery and battery chamber contact pins.

When main battery further drops down to 1%, the mobile computer shuts down automatically. Backup battery takes over to hold DRAM data, for 30 minutes if it is fully charged. Replace main battery pack immediately.

BACKUP BATTERY LEVEL

For user's immediate awareness of backup battery level, O.S. shows an  icon on [Title Bar](#) when battery level drops low.



STATUS ICONS

Backup battery icon delivers the following statuses:



Icon	Battery Status
	Battery level drops low and needs charging.

MORE CHARGE INFO

To learn more about backup battery level:

- 1) Tap Windows icon  on [Softkey bar](#) or hit physical Windows key .
- 2) Tap **Settings | System | Power**.

Power application opens showing Battery tabbed page. Backup battery level displays by a pie graph, which roughly sketches backup battery level:

Full	Partially drained	Low
		

LOW BATTERY ALERT

When backup battery drops low, the mobile computer prompts for recharge with a dialog. And [Title Bar](#) shows an  icon.

Backup battery is rechargeable by external power (through power adapter) or main battery pack.

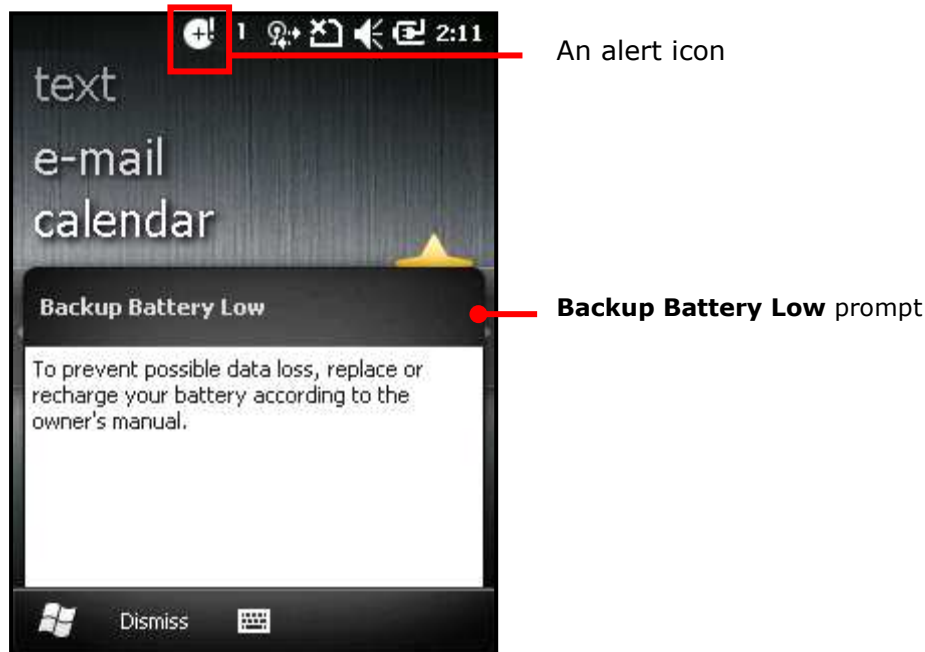

Low backup battery puts DRAM data in great danger. Always save data from time to time or keep a fresh battery at hand for replacement.

Once backup battery drains out completely, the data in DRAM is gone. Any data yet to be saved is lost!

POWER MANAGEMENT

The mobile computer features "suspension", a "soft-off" state allowing the mobile computer to consume less power and quickly to wake up.

The mobile computer auto-enters "suspension" when one of the following happens:

- ▶ When main battery drops under 7%.
- ▶ When placed face-down, which suggests the mobile computer isn't actively used.
- ▶ When battery door isn't in place.

And it wakes up from the following events:

- ▶ Power/Scan buttons being pressed
- ▶ WWAN ringing signal
- ▶ USB cable plugging

Note the mobile computer is also manually suspensible through Power button. See [Suspend Mobile Computer](#).

OPTIMIZE BATTERY LIFE

Power issues are critical for portable devices. Always turn off the features you don't need on the mobile computer to save power. To extend battery life as long as possible, always take the following actions:

- ▶ Suspend the mobile computer when it isn't actively used. (See [Suspend Mobile Computer](#).)
- ▶ Turn down LCD backlight brightness as described in [Adjust Backlight](#), and set a shorter LCD timeout as described in [Auto](#).
- ▶ Sync the mobile computer with your PC less frequently. See [Direct Data Connection](#).
- ▶ If you are using any "push e-mail" or any automatic syncing service on the mobile computer, change the syncing schedule to manually checking updates.
- ▶ When Wi-Fi, Bluetooth, mobile data (HSPA+), or GPS isn't used, turn it off. See [Radios](#).

TEXT INPUT

The mobile computer has a physical keypad and a touchscreen to receive user's input. Among the two, the touchscreen provides more intuitiveness than the physical keypad can offer to interact with the device.

This section shows how to input text using physical keypad and onscreen keyboard. To know how to touch-control the mobile computer, see [Touch Control](#).

PHYSICAL KEYPAD

The physical keypad sitting front the mobile computer is quite an advanced one with one step closer to laptop or PC keyboards. It supports multi-key operation, which normally requires two keys hit simultaneously, one of which a modifier key,

The physical keypad is either a numeric type or a QWERTY one. Each wedges a set of "enhanced keys" along the top and a set of character keys at the lower half.

Speaking of entering text, the numeric and QWERTY keypad are equally capable of entering numbers, letters, symbols and a few punctuations. And both get supplementary backlight as the screen does. (See [Keypad Backlight](#).)



Figure 7: Numeric Keypad



Figure 8: QWERTY Keypad

"ENHANCED KEYS"

"Enhanced keys" are arranged along the top of physical keypad and separated from character keys. Use these "enhanced keys" to launch actions from the mobile computer and O.S., cause the active application to work, or switch physical keypad between input modes. Navigation keys are included herein to move caret in a text input field.

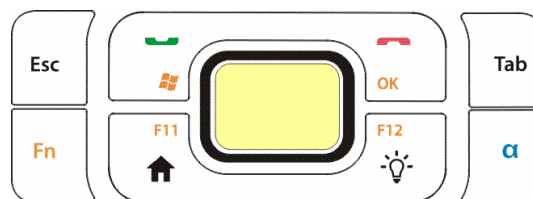



























Figure 9: Enhanced Keys

Enhanced keys can be categorized to five groups and explicated as follows:

Key Group	Description																		
Action Keys	<p>“Action keys” are Scan key and Backlight key. They cause the mobile computer to deliver functions as below:</p> <table border="1"> <thead> <tr> <th>Key</th> <th>Press</th> </tr> </thead> <tbody> <tr> <td> Scan Key</td> <td>Beams scanning light.</td> </tr> <tr> <td> Backlight Key</td> <td>Turns on/off screen/keypad backlight.</td> </tr> </tbody> </table>	Key	Press	 Scan Key	Beams scanning light.	 Backlight Key	Turns on/off screen/keypad backlight.												
Key	Press																		
 Scan Key	Beams scanning light.																		
 Backlight Key	Turns on/off screen/keypad backlight.																		
O.S. Keys	<p>The following tabulates O.S. keys and their functions. Some of them are engraved in orange color and need Fn key pressed beforehand to function while others don't.</p> <table border="1"> <thead> <tr> <th>Key</th> <th>Press</th> </tr> </thead> <tbody> <tr> <td>Windows </td> <td>Opens Start Screen. (Requires Fn key pressed beforehand.)</td> </tr> <tr> <td>OK</td> <td> <ul style="list-style-type: none"> ▶ Confirms input in an input field. (Requires Fn key pressed beforehand.) ▶ Delivers the same function as the “OK” command on Softkey bar does. (Requires Fn key pressed beforehand.) See Today Screen and Start Screen for more details about Softkey bar. </td> </tr> <tr> <td>Fn</td> <td>Changes what the next key pressed delivers so together they make O.S. take actions or produce functions F1 through F12.</td> </tr> <tr> <td>Call </td> <td>Launches phone or places a call.</td> </tr> <tr> <td>End </td> <td>Closes phone or ends a call.</td> </tr> <tr> <td>Home </td> <td>Opens Today Screen, the “home” screen of Windows Embedded Handheld 6.5.</td> </tr> <tr> <td>Esc</td> <td> <ul style="list-style-type: none"> ▶ Opens the previous screen worked on. ▶ Closes a menu of an application, or an opened dialog. </td> </tr> <tr> <td>Tab</td> <td> <ul style="list-style-type: none"> ▶ Navigates among the highlight items in some applications. ▶ Enters Tab character, which means it moves the caret to the next tab stop. </td> </tr> </tbody> </table>	Key	Press	Windows 	Opens Start Screen . (Requires Fn key pressed beforehand.)	OK	<ul style="list-style-type: none"> ▶ Confirms input in an input field. (Requires Fn key pressed beforehand.) ▶ Delivers the same function as the “OK” command on Softkey bar does. (Requires Fn key pressed beforehand.) See Today Screen and Start Screen for more details about Softkey bar. 	Fn	Changes what the next key pressed delivers so together they make O.S. take actions or produce functions F1 through F12 .	Call 	Launches phone or places a call.	End 	Closes phone or ends a call.	Home 	Opens Today Screen , the “home” screen of Windows Embedded Handheld 6.5.	Esc	<ul style="list-style-type: none"> ▶ Opens the previous screen worked on. ▶ Closes a menu of an application, or an opened dialog. 	Tab	<ul style="list-style-type: none"> ▶ Navigates among the highlight items in some applications. ▶ Enters Tab character, which means it moves the caret to the next tab stop.
Key	Press																		
Windows 	Opens Start Screen . (Requires Fn key pressed beforehand.)																		
OK	<ul style="list-style-type: none"> ▶ Confirms input in an input field. (Requires Fn key pressed beforehand.) ▶ Delivers the same function as the “OK” command on Softkey bar does. (Requires Fn key pressed beforehand.) See Today Screen and Start Screen for more details about Softkey bar. 																		
Fn	Changes what the next key pressed delivers so together they make O.S. take actions or produce functions F1 through F12 .																		
Call 	Launches phone or places a call.																		
End 	Closes phone or ends a call.																		
Home 	Opens Today Screen , the “home” screen of Windows Embedded Handheld 6.5.																		
Esc	<ul style="list-style-type: none"> ▶ Opens the previous screen worked on. ▶ Closes a menu of an application, or an opened dialog. 																		
Tab	<ul style="list-style-type: none"> ▶ Navigates among the highlight items in some applications. ▶ Enters Tab character, which means it moves the caret to the next tab stop. 																		
Navigation Keys	<p>The buttons  skirting Scan key are the up/down/right/left navigation keys. They move the caret in an input field. In certain applications, they navigate vertically or horizontally among highlight items.</p>																		
Function Keys	<p>F1 through F12 are known as the functions keys on physical keypad. They are all application-dependent and they all team up with Fn key to cause actions from the active application. They produce nothing when pressed alone.</p>																		
[Alpha] Key	<p>α key changes keypad input mode. Continuously press α key to freely switch between literal input and numeric/symbol input.</p> <p>α key enables maximum six input states for physical keypad. However state availability depends on keypad type, numeric or QWERTY. The icons , , , , , or  on Title Bar signify current input state.</p> <p>Physical keypad input states:</p>																		

State	Description
a A A	Physical keypad enters alphabetic characters, i.e. letters.
1 1 1	Physical keypad enters numbers and symbols.

For details about shift key, see numeric keypad's [Shift](#) ⤴ and QWERTY keypad's [Shift key](#) ⤴.

NUMERIC KEYPAD CHARACTER KEYS

Numeric keypad wedges a set of character keys at the lower half. They are laid out analogously to a telephone keypad plus all the **Enter** key, backspace ←, and shift key ⤴ that enable more sophisticated text input.

Numeric keypad enters numbers 0 through 9 (and symbols * and #) by default. To enter alphabetic characters, use **α** key. See [\[Alpha\] Key](#) for more details.

For all the characters the numeric keypad enters, see Appendix V: [Numeric Keypad](#).

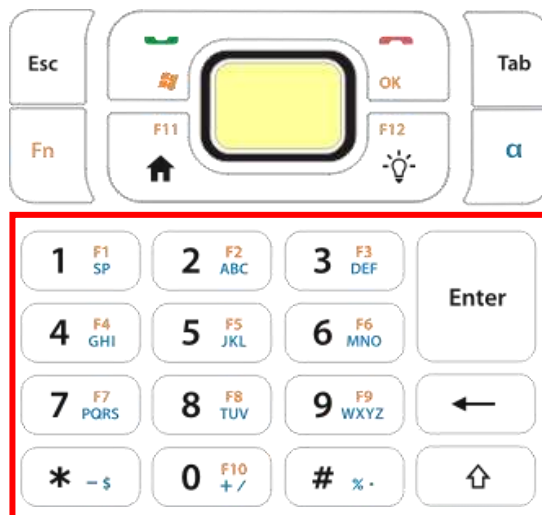

Key	Description						
Enter Key	Executes a command or confirms input. For text input, it inserts a break between paragraphs.						
Backspace ←	Erases the characters to the left of caret.						
Space SP	Inserts a blank space where caret is.						
Shift ⤴	<p>Changes numeric keypad between numbers and symbols inputs.</p> <ul style="list-style-type: none"> ▶ Teamed up with α key, shift key ⤴ changes numeric keypad between six input states. The icons a, A, A, 1, 1 or 1 on Title Bar signify current input state. <p>Numeric keypad input states:</p> <table border="1"> <thead> <tr> <th>State</th> <th>Description</th> <th>Withdrawal</th> </tr> </thead> <tbody> <tr> <td>a</td> <td>Keypad enters all lowercase letters.</td> <td>This state doesn't quit unless α key or shift key is pressed.</td> </tr> </tbody> </table>	State	Description	Withdrawal	a	Keypad enters all lowercase letters.	This state doesn't quit unless α key or shift key is pressed.
State	Description	Withdrawal					
a	Keypad enters all lowercase letters.	This state doesn't quit unless α key or shift key is pressed.					

A	Keypad capitalizes the (one) letter typed.	This state quits once a letter is entered, and numeric keypad restores to a state.
A	Keypad capitalizes all the letters typed.	This state doesn't quit unless α key or shift key is pressed.
1	Keypad enters numbers 0 through 9 (and symbols * and #).	This state doesn't quit unless α key or shift key is pressed.
1	Keypad enters the (one) symbol typed.	This state quits once a character is entered, and numeric keypad restores to 1 state.
1	Keypad enters all the symbols typed.	This state doesn't quit unless α key or shift key is pressed.

For details about **α** key, see [\[Alpha\] Key](#).

TEXT INPUT

To enter text by numeric keypad:

▶ Literal Input

- 1) Press **α** key continuously until seeing an **a**, **A** or **A** on [Title Bar](#).

Numeric keypad readies to enter one lowercase letter (**a**), one uppercase letter (**A**) or all caps (**A**).

- 2) Continuously press a key engraved with blue-color character until the character you desire is entered.

If you need to change the case, use shift key **↑**.

▶ Numbers (and symbols * and #) Input

- 1) Continuously press **α** key and/or shift key **↑** until seeing an **1** on [Title Bar](#).

Numeric keypad readies to enter numbers 0 through 9 (and symbols * and #).

- 2) Press one or more key(s) engraved with white-color characters to enter it/them.

▶ Symbols Input

Press **α** key and/or shift key **↑** continuously until seeing an **1** or **1** on [Title Bar](#). **1** means numeric keypad readies to enter one symbol while **1** means numeric keypad readies to continuously enter more symbols.

Note there are cases when a typed letter is capitalized automatically:

- ▶ The letter succeeds a period mark and a blank space (because it is reckoned as starting a new sentence).
- ▶ The letter is typed after a paragraph break (because it is reckoned as starting a new paragraph).

QWERTY KEYPAD CHARACTER KEYS

QWERTY keypad also arranges its character keys in the lower half and features them in a compact “QWERTY” layout as its name suggests.

QWERTY keypad is a pared down version of an average laptop’s keyboard that bears each Ctrl and Alt key in addition to Enter, backspace ←, and shift keys ⇧.

QWERTY keypad enters alphabetic characters by default. To enter numbers and some symbols, press **α** key. See [\[Alpha\] Key](#) for more details.

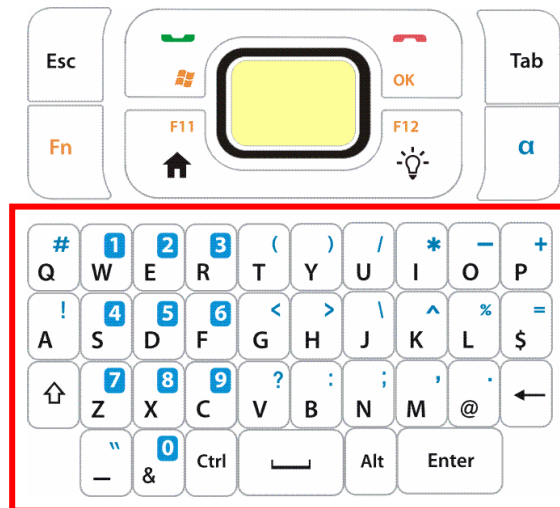

For all the characters the QWERTY keypad enters, see Appendix V — [QWERTY Keypad](#).



MODIFIER KEYS

Ctrl key, Alt key and shift key ⇧ are the modifier keys. Ctrl / Alt key is pressed with another key to launch particular actions from O.S. or the active application while shift key ⇧ capitalizes the letter(s) typed.

Key	Description									
Ctrl key	Performs a special operation from O.S. or the active application when pressed in conjunction with another key.									
Alt key	Changes the function of the key pressed together with. The launched function depends on applications.									
Shift key ⇧	<p>This shift key ⇧ doubles as “Caps Lock”. Press it once to capitalize the (one) letter typed. Press it twice to enter all caps.</p> <p>Teamed up with α key, shift key ⇧ changes QWERTY keypad between four input states. The icons a, A, A or 1 on Title Bar signify current input state. They communicate the following states:</p> <table border="1"> <thead> <tr> <th>State</th> <th>Description</th> <th>Withdrawal</th> </tr> </thead> <tbody> <tr> <td>a</td> <td>Keypad enters all lowercase letters.</td> <td>This state doesn’t quit unless α key or shift key is pressed.</td> </tr> <tr> <td>A</td> <td>Keypad capitalizes the (one) letter typed.</td> <td>This state quits once a key is pressed. QWERTY keypad restores to a state.</td> </tr> </tbody> </table>	State	Description	Withdrawal	a	Keypad enters all lowercase letters.	This state doesn’t quit unless α key or shift key is pressed.	A	Keypad capitalizes the (one) letter typed.	This state quits once a key is pressed. QWERTY keypad restores to a state.
State	Description	Withdrawal								
a	Keypad enters all lowercase letters.	This state doesn’t quit unless α key or shift key is pressed.								
A	Keypad capitalizes the (one) letter typed.	This state quits once a key is pressed. QWERTY keypad restores to a state.								

	Keypad capitalizes all the letters typed.	This state doesn't quit unless a key or shift key is pressed.
	Keypad enters numbers and symbols.	This state doesn't quit unless a key is pressed.

OTHER KEYS

Key	Description
Enter key	Executes a command or confirms input. When text input, it inserts a break between paragraphs.
Backspace ←	Erases the characters to the left of caret.
Space —	Inserts a blank space where caret is.

TEXT INPUT

To enter text using QWERTY keypad:

▶ Literal Input

- 1) Press **a** key continuously until seeing an **a**, **A** or **A** on [Title Bar](#).
QWERTY keypad readies to enter one lowercase letter (**a**), one uppercase letter (**A**) or all caps (**A**).
- 2) Press a key engraved with a white color character to enter it.
To capitalize one or more letter(s) to enter, use shift key .

▶ Numbers & Symbols Input

- 1) Press **a** key continuously until seeing an **1** icon on [Title Bar](#).
QWERTY keypad readies to enter numbers and symbols.
- 2) Press a key printed with a blue-color character to enter it.

Note there are cases when a letter typed is auto-capitalized:

- ▶ The letter succeeds a period mark and a blank space (because it is reckoned as starting a new sentence).
- ▶ The letter is typed after a paragraph break (because it is reckoned as starting a new paragraph).

CHANGE INPUT TEXT SIZE

Set the size to show typed text:

- 1) On Start screen, tap **Settings | System | Screen | Text Size**.
- 2) Tap **Text Size** tab.
- 3) Adjust the text size by moving the slider.
- 4) Tap the "OK" command on [Softkey bar](#) to apply the change and quit setting.

ONSCREEN KEYBOARD

The O.S. provides users with an onscreen keyboard. Compared to physical keypads, the onscreen keyboard bears more likeness to a conventional laptop's keyboard by all the modifiers keys arranged on the left edge and the "QWERTY" layout. The onscreen keyboard isn't overshadowed by physical keypads at all but outdoing them by being able to enter a series of diacritics for European languages.

Onscreen keyboard auto-opens in some applications while in others it doesn't unless you tap on a field that accepts input.

In case the onscreen keyboard doesn't open, tap the keyboard icon  on [Softkey bar](#) to open it.

Onscreen keyboard opens and readies to enter lowercase letters, numbers, and a few frequently used symbols.

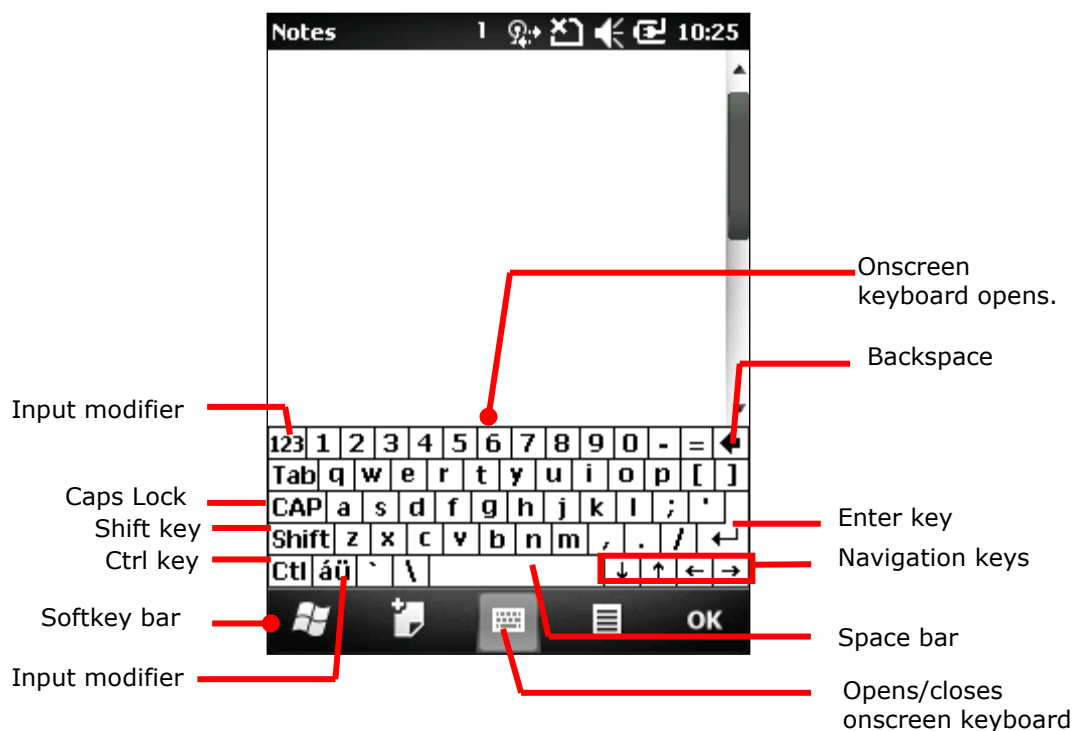

MODIFIER KEYS













Although the touchscreen is a resistive single-touch type, use of modifier key, which normally involves hitting two keys, are still available on onscreen keyboard.

On onscreen keyboard there are five modifier keys. They all sit at the left edge. This is how they basically work:

- 1) Hit a modifier key on onscreen keyboard.
The onscreen keyboard enters modifier state.
- 2) Hit the second key.

The desired performance will be produced to the active application or screen at the moment.

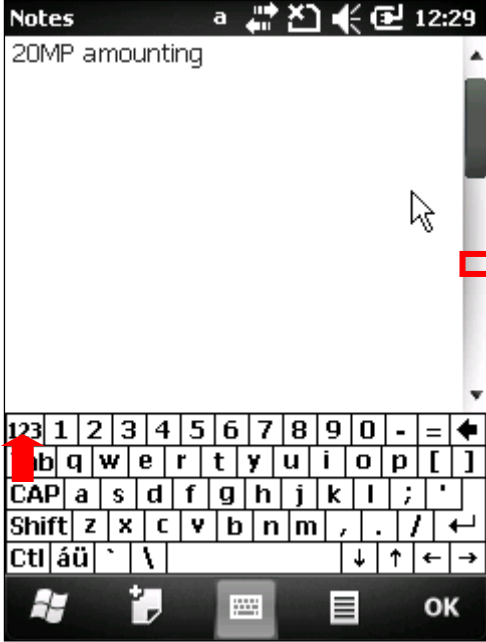
Modifier keys are explicated as following

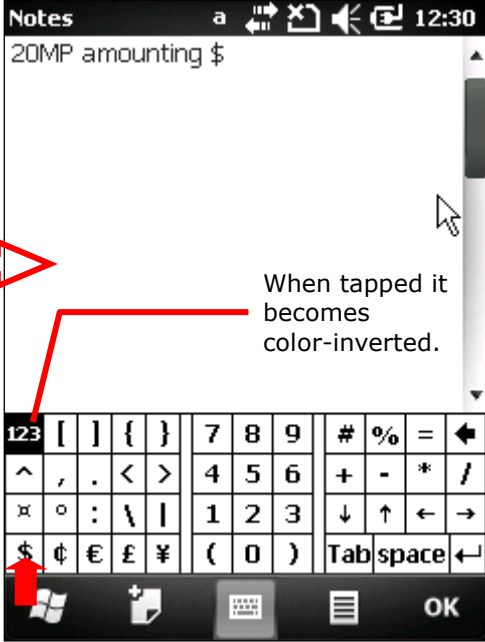
Key	Description
Ctrl key 	<p>Once tapped, it becomes color-inverted  and causes a special action from O.S. or the active application when a character key is tapped. It quits once said action is triggered or when it is tapped again.</p> <p>For example: Tap  key and then tap key "A" to produce Ctrl+A function, which in Windows environment mostly selects all content on the active screen. And once "A" is tapped, the onscreen keyboard quits Ctrl state.</p>
Shift key 	<p>Once tapped, it becomes color-inverted  and capitalizes the (one) letter typed. It quits once a character key is tapped or it is tapped again.</p> <p>To enter all caps, use Caps Lock .</p>
Caps Lock 	<p>Once tapped, it becomes color-inverted  and capitalizes all the alphabetic characters typed. It doesn't quit until it is tapped again.</p> <p>This key does not affect numbers, punctuation marks, or symbols.</p>
Input modifier 	<p>Once tapped, it becomes color-inverted  and presents more symbols and a set of digits and enters them. It won't quit until it is tapped again.</p> <div style="display: flex; justify-content: space-around; align-items: flex-start;"> <div style="text-align: center;">  <p>Tap input modifier .</p> </div> <div style="text-align: center;">  <p>And have more symbols with a set of digits.</p> </div> </div> <p style="text-align: right; margin-right: 100px;">When tapped it becomes color-inverted.</p>

Input modifier
áü

Once tapped, it becomes color-inverted **áü** and presents a series of accented vowels such as ä, æ, ë, ì, ö, ú or letter variants such as ß and ç which are needed for European languages. It quits once a character key is tapped.

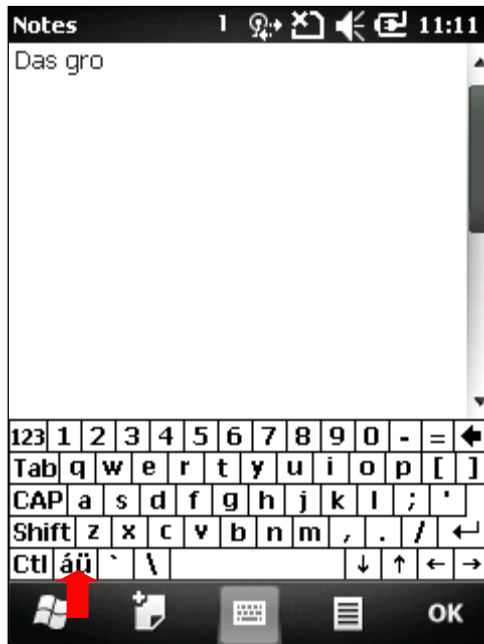

Tap **áü** key on onscreen keyboard.

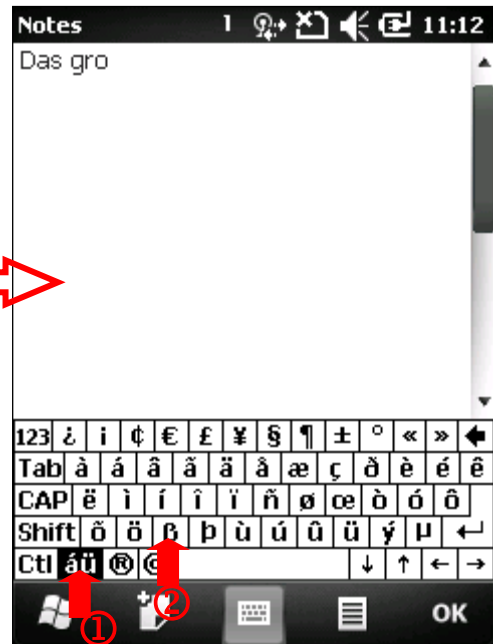

áü key becomes color-inverted **áü**. Then tap a character key.

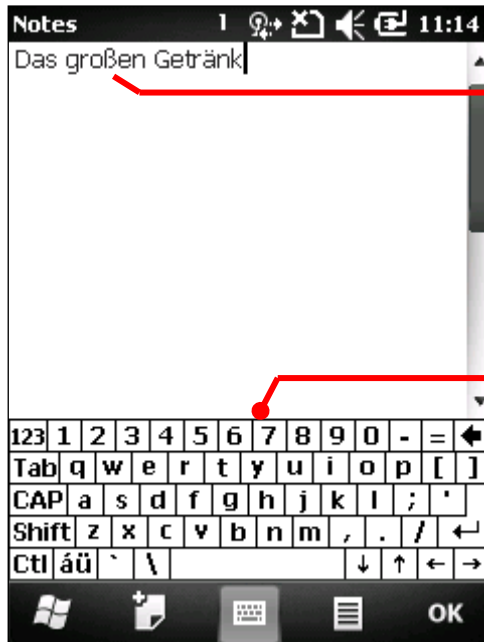

Letter variant "ß" is entered.

Once an accented vowel or letter variant is entered, the onscreen keyboard restores to English keyboard.

After the letter variant "ß" is entered, the onscreen keyboard restores to normal English alphanumeric layout.

Diacritical letters and letter variants are presented both lowercase and uppercase.



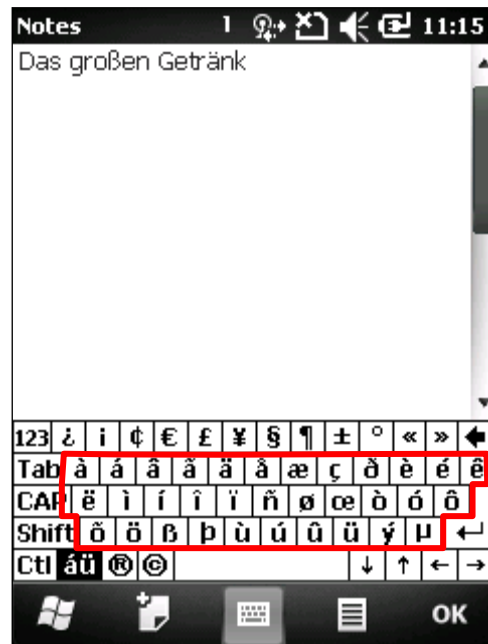

Lowercase

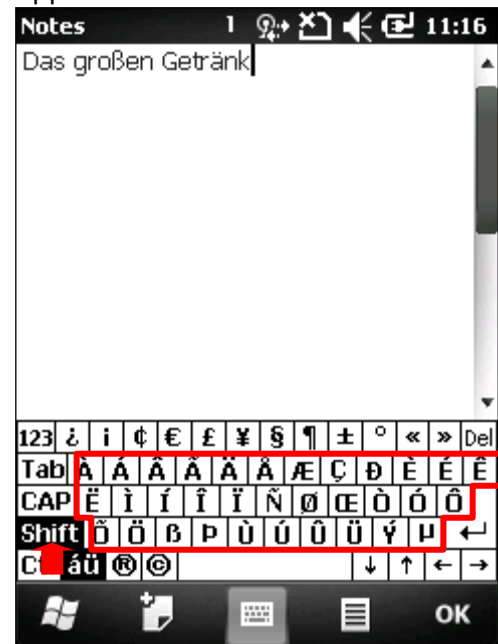

Uppercase

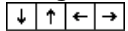

OTHER KEYS

Key	Description
Tab key 	Navigates among the highlight items in some applications. For text input, it inserts Tab character, which means it moves caret to the next tab stop.
Backspace 	Erases the characters to the left of caret.
Enter key 	Executes a command or confirms input. When text input, it inserts a break between paragraphs.
Navigation keys 	Move caret in an input field. In certain applications, they navigate vertically or horizontally among highlight items.
Spacebar 	Inserts a blank space where caret is.

DICTIONARY

Onscreen keyboard comes with an English dictionary. When onscreen keyboard is opened, the dictionary is enabled and lets you quick-enter the words you're typing.

When you tap a letter key on the onscreen keyboard, a list of suggested words displays shortly over the keyboard. Tap a suggested word from the list to enter it. When you have entered a word that is not in the dictionary, it is added to the dictionary and becomes a suggestible word next time.

The screenshot below shows an example when "L" is entered on onscreen keyboard:

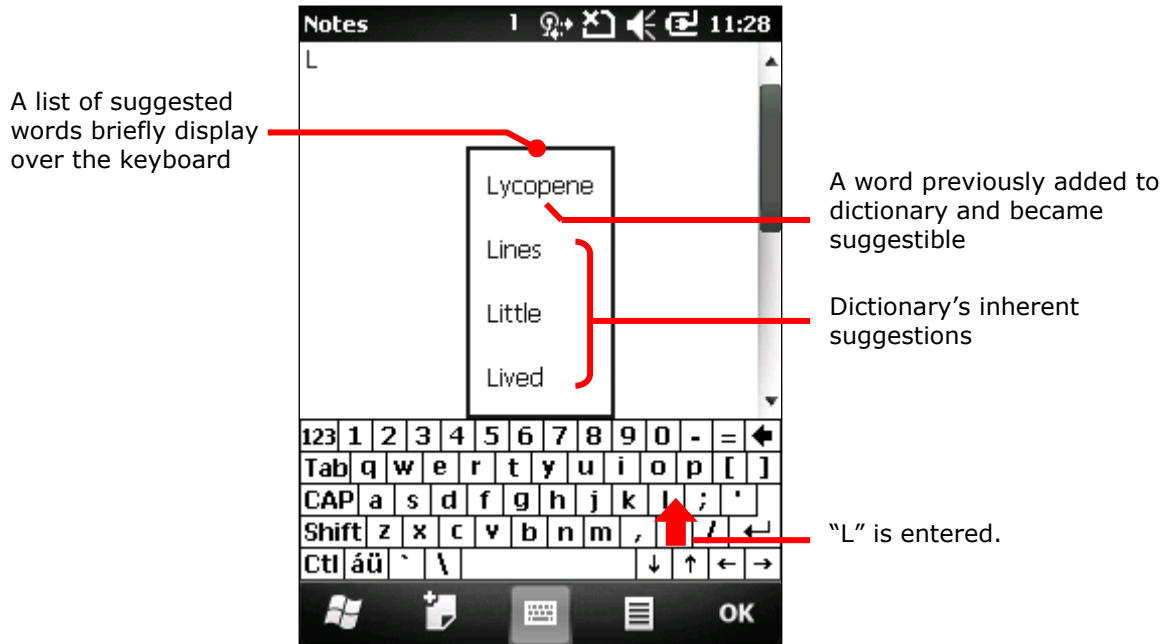

CHANGE KEYBOARD ORIENTATION

The mobile computer is built-in with a G-sensor and supports screen orientation, which is enabled by default. So when the mobile computer turns sideways or upright, the screen changes its orientation, and onscreen keyboard readjusts itself to the new orientation.

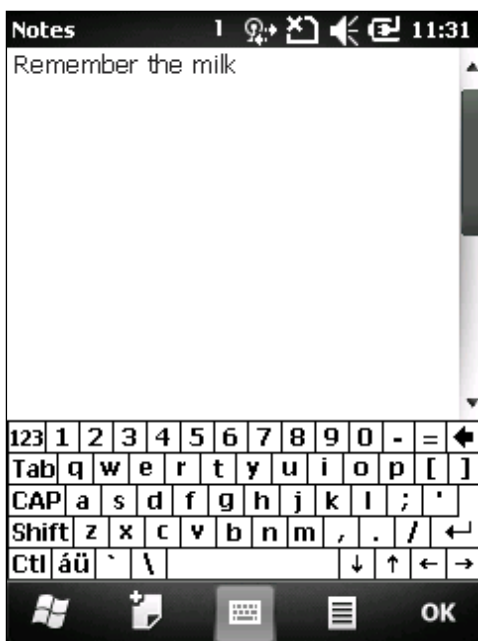

Upright (Portrait Mode)



Sideways (Landscape Mode)

To disable **Automatic screen rotation**, see [Screen Orientation](#).

CHANGE TEXT INPUT SIZE

See [Change Input Text Size](#).

HANDWRITING RECOGNITION

Onscreen text input doesn't necessarily rely on onscreen keyboard. "Handwriting Recognition" can also get the job done. "Handwriting Recognition" is an input method that interprets and converts user's handwriting received through touchscreen to text.

A few handwriting "input methods" are bundled with the O.S. To launch them:

- 1) Tap & hold the keyboard icon  on [Softkey bar](#)

A context menu pops up.

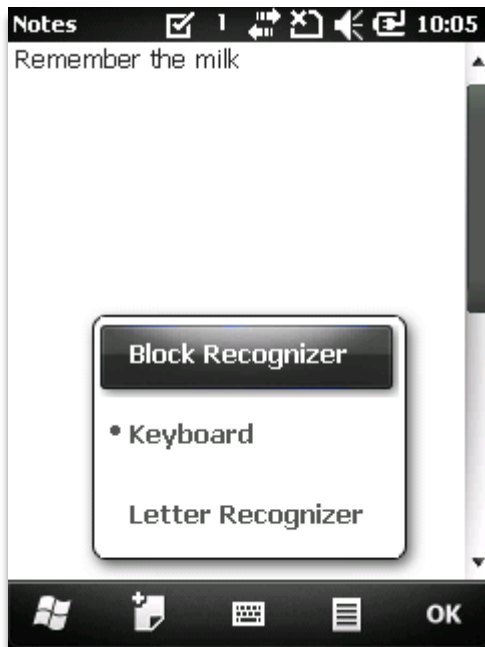

- 2) Select between **Block Recognizer** and **Letter Recognizer** for handwriting recognition.

BLOCK RECOGNIZER

Also known as "Graffiti", a writing system used on Palm O.S.-based PDAs. It recognizes handwriting by the particular "neography" that relies on user drawing an uppercase letter with a single stroke. The name comes from the feature of its drawing area divided to two blocks to admit each letters-drawing and numbers-drawing.

To enter text:

Write any letter, number, and punctuation with a single stroke. Block Recognizer then converts it into typed text.

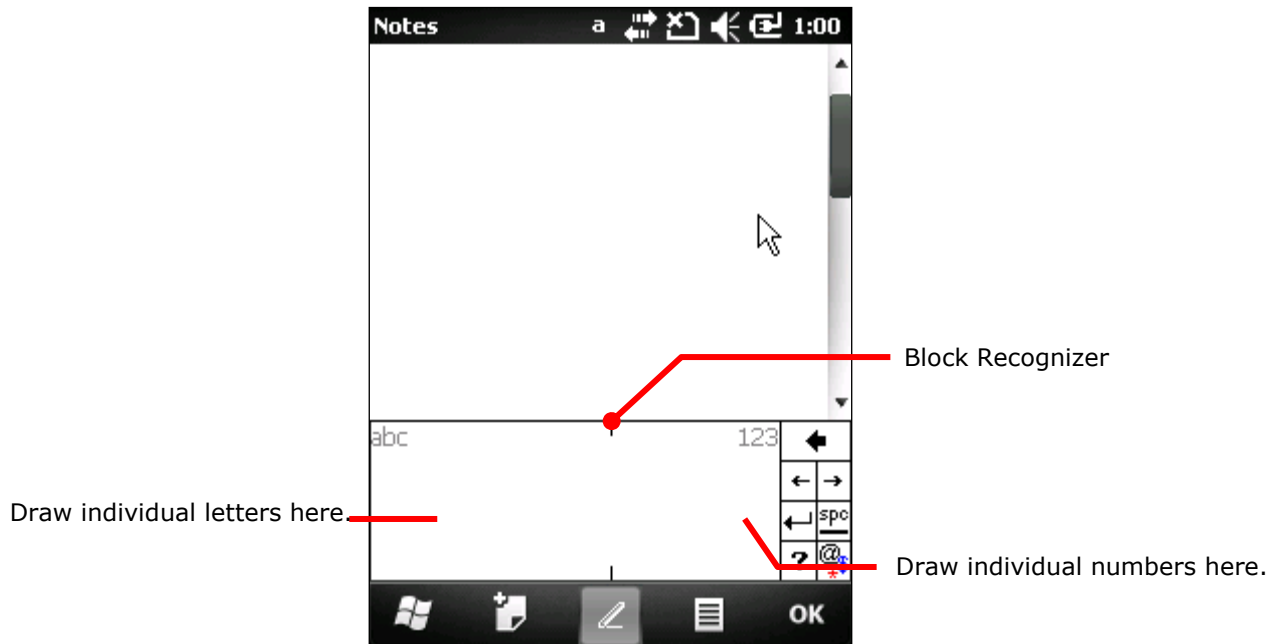

LETTER RECOGNIZER

“Letter Recognizer” presents a writing pad divided in three areas. Each respectively detects uppercase letters, lowercase letters, and numbers/symbols/punctuations.

To enter text:

Write individual letters, numbers, and numbers/symbols in respective area. Letter Recognizer then converts them to typed text.

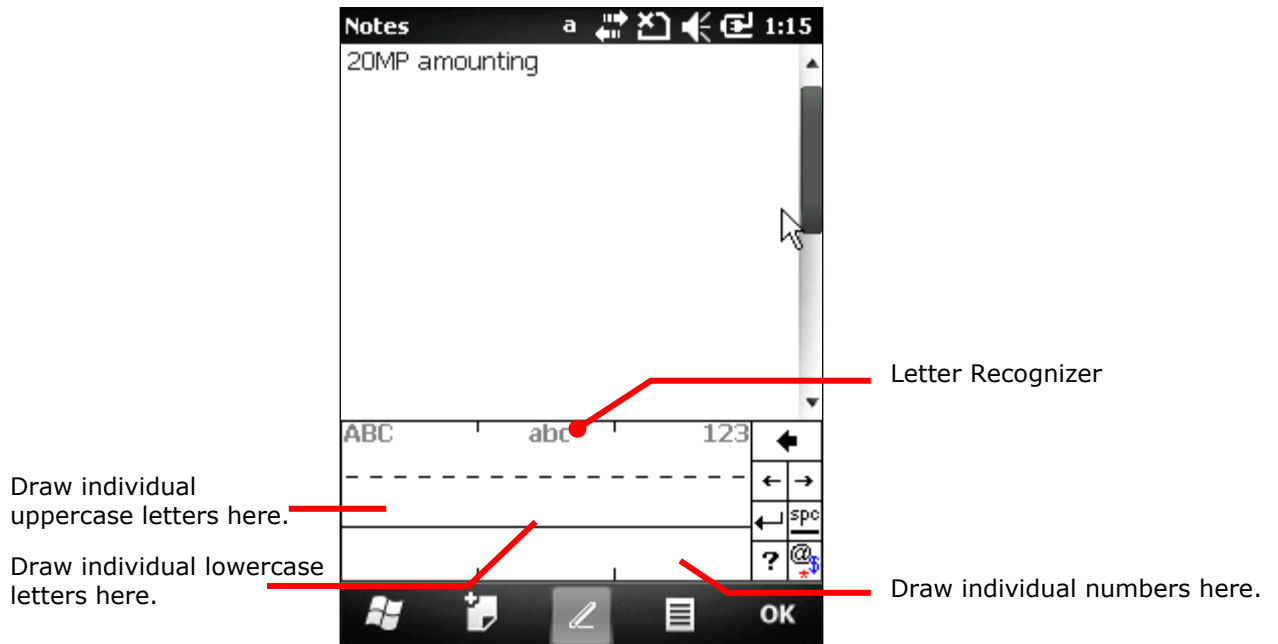

CHANGE TEXT INPUT SIZE

See [Change Input Text Size..](#)

EDIT TEXT

On the mobile computer, cut, copy, and paste text within an application or across applications by the menu commands. Some applications don't support editing some or all of the text they display while others may offer their own way to edit text.

EDIT TEXT IN INPUT FIELDS

To edit text in a text input field:

- 1) Tap where you want to edit text.

Caret moves there and manifests itself as a vertical bar that blinks to indicate where the typed or pasted text will be inserted.

- 2) Type, paste or delete text.

To paste text, see [Paste Text.](#)

SELECT TEXT

When you see some text on a page you want to copy, select it first. Selecting texts varies from application to application. But primarily it takes you to tap & hold somewhere on the text to open a context menu or open the applications' option menu which provide commands to select a text.

To select a text:

- 1) Tap & hold somewhere on the text.
A context menu comes up.
- 2) Tap the command that makes selection.
- 3) Select the desired text.

It relies on defining the start and end to make selection of a text. Some applications support tapping and dragging along the text to select it while others require you to mark the start and end of the desired text with the onscreen facility featured by the application.

CUT OR COPY TEXT

After a text is selected, system then presents Copy/Cut commands on "[Softkey bar](#)" or a context menu shows up featuring Copy/Cut commands. Tap them to copy/cut the selected text.

PASTE TEXT

Within the O.S., texts can be copied to and from between applications.

To paste a text:

- 1) Tap & hold the text field where you want to paste the text.
Context menu opens.
- 2) Tap the "Paste" command from the context menu.
The copied/cut text is pasted.

TOUCH CONTROL

The mobile computer's LCD is overlaid by a resistive touch panel and thus forms a resistive touchscreen. Since a resistive touchscreen locates user's touch by the force applied on it, it needs your operation with a pointed object such as a pen, your fingertip (fingernail) or stylus so it takes you the easiest minimum force to trigger actions from the touchscreen.

Touch control is one of the main ways to interact with the mobile computer. Users are able to manipulate icons, buttons, menu commands, the onscreen keyboard, or any onscreen items with touch control.



USE TOUCHSCREEN

The mobile computer comes with a stylus. Touch-operate the mobile computer with the stylus or simply your fingertip. Take the gestures below to work on the touchscreen:

- ▶ **Tap** – Touch any item on the screen such as an application icon or a setting icon to work on them, or touch any key on the onscreen keyboard to type it.
- ▶ **Tap & hold** – Touch an item on the screen and do not release until an action occurs.
- ▶ **Drag** – Touch and hold an item for a moment and then, without release, move the item onscreen until you reach the target.
- ▶ **Flick** – Quickly move your finger or stylus across the surface of the screen. Note when the stylus contacts the screen, do not pause so you don't drag an item instead. Flick is helpful, for example, for scrolling up or down a list.
- ▶ **Double-tap** – Touch quickly twice on a webpage or other screen to zoom. For example, double-tap a section of a webpage in a web browser to zoom that section to fit the width of the screen. Some applications such as map-info applications support picture zooming with double-tap.
- ▶ **Rotate screen** – On most screens, the screen rotates as the mobile computer changes its orientations between upright and sideways. To enable/disable automatic screen orientation, see [Screen Orientation](#).

SCREEN ORIENTATION

The mobile computer has a built-in G-sensor for screen orientation, which is enabled by default. To disable it:

- 1) Tap Windows icon  on [Softkey bar](#) or hit physical Windows key .
Start screen opens.
- 2) Tap **Settings | System | G-sensor** .
G-Sensor setting opens.
- 3) Deselect **Automatic screen rotation**.
- 4) Tap the "OK" command on [Softkey bar](#) to apply the change and quit setting.

ADJUST BACKLIGHT

To adjust LCD backlight

- 1) Tap Windows icon  on [Softkey bar](#) or hit physical Windows key .
Start screen opens.

- 2) Tap **Settings | System | Backlight**  .
Backlight settings open.
- 3) Select between **Battery Power** and **External Power** tabbed pages.
- 4) Select **Manual brightness control** and manually adjust the brightness level, or deselect **Manual brightness control** and leave the brightness on automatic.

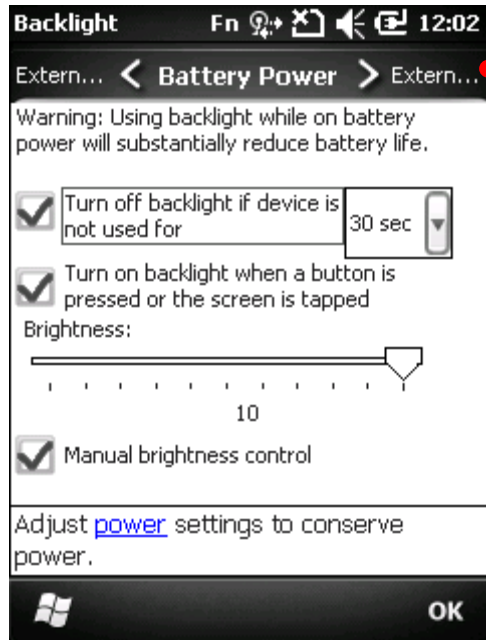



Backlight's Battery Power tabbed page

CALIBRATION

A resistive touchscreen needs calibration to work accurately after serving for a period of time. Calibration aligns the coordinates of touch panel and the LCD underneath to improve touch accuracy.

To calibrate touchscreen:

- 1) Tap Windows icon  on [Softkey bar](#) or hit physical Windows key  .
Start screen opens.
- 2) Tap **Settings | System | Screen**  .
Screen settings open showing Alignment tabbed page.

- 3) Tap **Align Screen** button.

Screen alignment application opens.

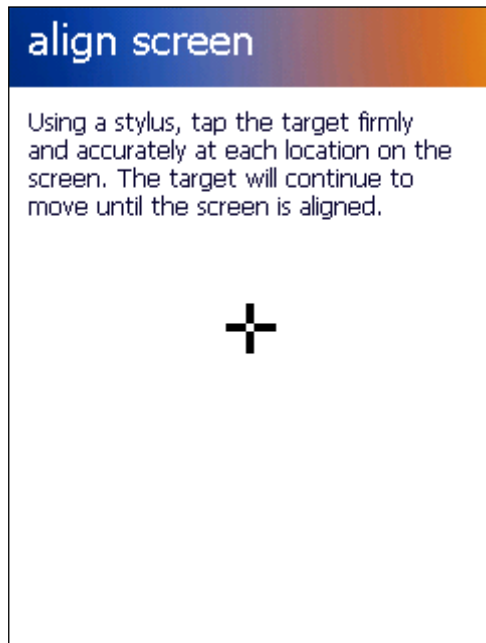

- 4) Accurately tap on the centers of each cross mark to show consecutively onscreen, 5 in total.
- 5) Follow through the calibration.

MEMORY

The mobile computer packs the following memory units to retain data and instructions from users:

- ▶ Random-access Memory (RAM)

256 MB SDRAM for temporary storage and fast access of active applications. SDRAM is fed by backup battery to hold data.

- ▶ Internal Storage

2GB flash memory to store O.S. (Windows Embedded Handheld 6.5), application files, settings, and other data used by applications.

- ▶ External Storage

Insert a storage card to increase the mobile computer's storage capacity. Supported are MicroSD cards from 256MB to 4GB and MicroSDHC cards from 4GB to 32GB.

DATA LOSS CAUTION

When main battery is absent or used up, backup battery on the main board takes over to supply power to the mobile computer. A fully charged backup battery retains SDRAM data and suspends the mobile computer for 30 minutes.

Note if you are leaving the mobile computer to sit for a couple of days, data loss is to occur when both main and backup batteries drain out. Consider backing up data before putting away the mobile computer.

CHECK STORAGE

RAM SIZE

To check RAM size:

From Start screen, tap **Settings | System | Device**

Information  to open Device Information. It opens retrieving the information about the mobile computer, including device manufacturer, device ID, memory size, and firmware/software version. Find RAM size among the listed.

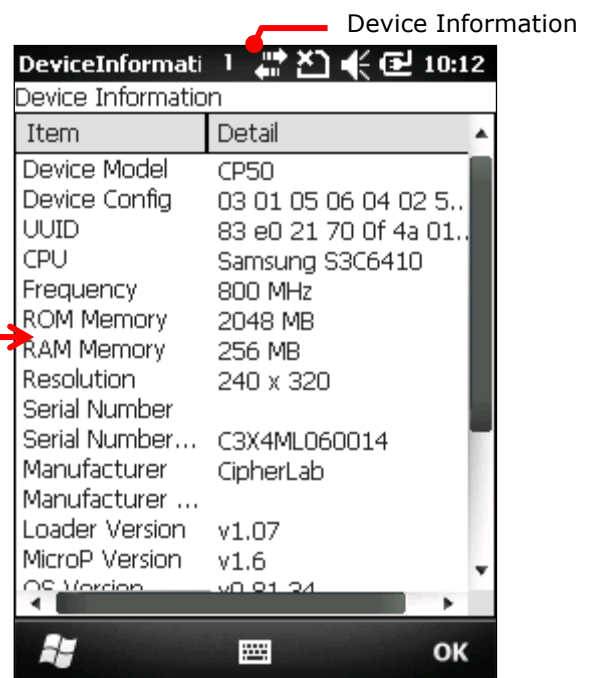

INTERNAL STORAGE

On Start screen, tap **Settings | System | Memory**. Memory screen opens showing Main tabbed page. This page gives the information about the mobile computer’s use of RAM and internal storage.

Main tabbed page delivers two labels – **Storage** and **Program**:

- ▶ **Storage** - Internal memory for files storage, such as O.S., applications and the files needed for applications.
- ▶ **Program** - RAM usage for running applications.

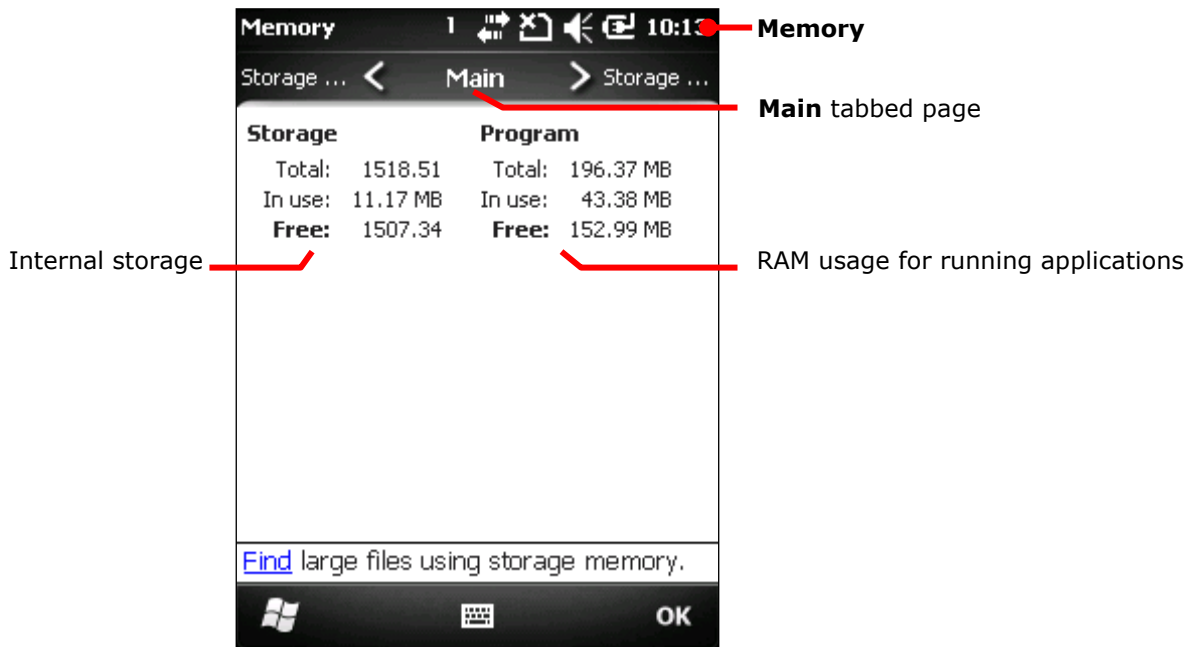

EXTERNAL STORAGE

When Memory screen opens, tap **Storage Card** tab. **Storage Card** tabbed page then opens and shows the info about external storage (when a storage card is inserted).

External storage usage

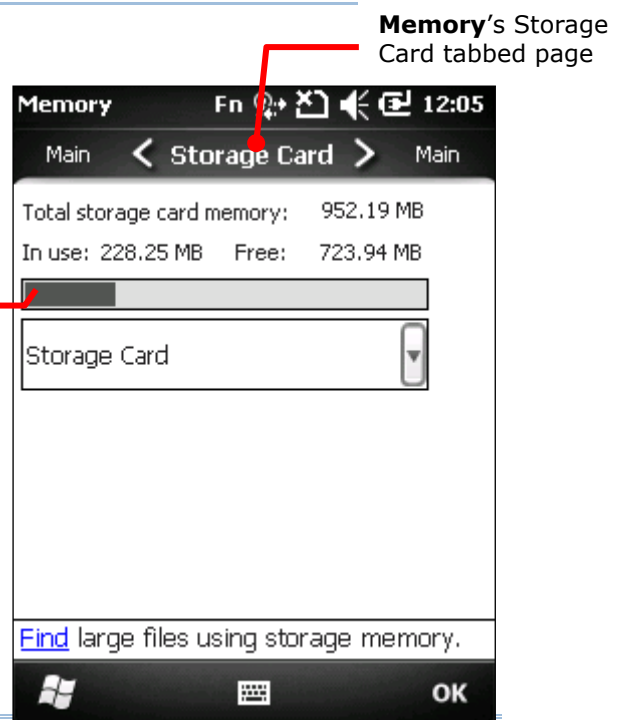

INSERT SD CARD

By your day-to-day use of the mobile computer, available internal storage may run short. Invest the mobile computer with an external memory unit to expand storage capacity.

Follow through the steps below to install a SD card:

- 1) Power off the mobile computer.
- 2) Place the mobile computer face-down on a flat and soft surface.
- 3) Remove the battery door and main battery pack as described in [Main Battery Setup](#).
Battery chamber is opened.
- 4) Find SD card socket inside battery chamber. (See [Inside Battery Chamber](#).) The SD card socket is equipped with a hinged cover.

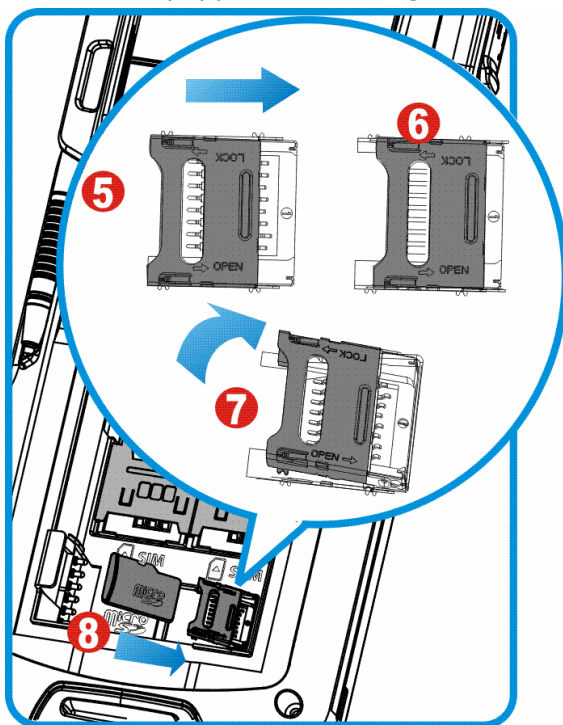

- 5) Push the hinged cover to the open position.
- 6) The hinged cover unlocks.
- 7) Swivel up the cover.
- 8) Have the SD card. Position it with the metal contacts face-down as the signage  besides the socket illustrates. Fit the SD card into the socket.
- 9) Put down the hinged cover. Push-lock the cover.
- 10) Restore main battery pack and the battery door.

Figure 10: Inserting SD Card

DIRECT DATA CONNECTION

“Direct” data connection means “hardwired” data connection between the mobile computer and a Windows-based PC as opposed to wireless connection. Direct data connection relies on a serial cable or a USB cable (sometimes plus an auxiliary cradle) between two devices.

Once two devices are “directly” connected with each other by a serial- or USB-cable, they can sync data with each other, and the mobile computer, more precisely the SD card in it, can mount the PC as mass storage.

USE CABLE

Direct data connection using a cable:

- 1) Connect the mobile computer to your PC with a USB or serial-cable. Fix the cable to both sides.
- 2) Power on the mobile computer if you haven't.
- 3) On the mobile computer, open Start screen, tap **Settings | Connections | USB**

Connection .

USB Connection opens.

- 4) Select **ActiveSync** or **Mass Storage**.

Note: (1) RS232 serial cable doesn't support ActiveSync.
(2) **Mass Storage** only mounts the external SD card.

- 5) Tap the “OK” command on [Softkey bar](#) to apply the change and quit setting.

See [Syncing Tools](#) and subsequent sections to know how to use ActiveSync.

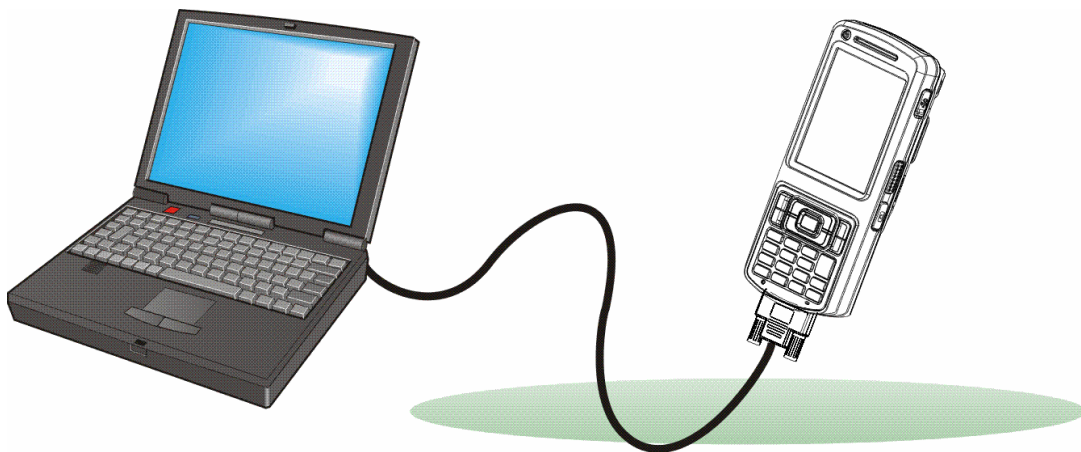

Figure 11: Direct Data Connection Using Cable

USE CRADLE

Direct data connection using a cradle:

- 1) Seat the mobile computer in a Charging and Communication Cradle (hereinafter “cradle”).

- 2) Connect the cradle to your PC with a serial- or USB cable. Fix the cable to both sides.
- 3) Power on the mobile computer if you haven't.
- 4) On the mobile computer, open Start screen, tap **Settings | Connections | USB**

Connection .

USB Connection opens.

- 5) Select **ActiveSync** or **Mass Storage**.

Note: (1) RS232 serial cable doesn't support ActiveSync.
(2) **Mass Storage** only mounts the external SD card.

- 6) Tap the "OK" command on [Softkey bar](#) to apply the change and quit setting.

See [Syncing Tools](#) and subsequent sections to know how to use ActiveSync.

See also [Charging & Communication Cradle](#).



Figure 12: Direct Data Connection Using Cradle

SYNCING TOOLS

Microsoft's syncing tools enables users to update or back up the data on their handheld computers to desktop computers.

Two syncing tools are featured by Microsoft - ActiveSync and Windows Mobile Device Center (hereinafter "WMDC"). Which tool to use depends on which OS is running on your PC. See the rule below:

O.S.	Syncing Program
Windows Vista or Windows 7	WMDC 
Windows XP SP3 and earlier	ActiveSync 

ActiveSync and WMDC are downloadable from Microsoft's website. Download and install the right one on your PC.

Hereafter in this manual, we will focus on ActiveSync only. For WMDC usage, see its documentation or help file.

SYNC PARTNERSHIP

Once a USB direct connection is established between the mobile computer and your PC as described in [Use Cable](#) or [Use Cradle](#), they are able to form the following ties:

Sync Partnership	Services
Synchronization Relationship	<ul style="list-style-type: none"> ▶ Two computers to sync Microsoft Office Outlook data with each other. ▶ PC to add and remove programs to/from the mobile computer. ▶ PC to browse files on the mobile computer. ▶ PC to copy files to/from the mobile computer. ▶ PC to back up the files on the mobile computer.
Temporary Relationship (Mobile computer works as a "guest" for PC.)	<ul style="list-style-type: none"> ▶ PC to add and remove programs to/from the mobile computer. ▶ PC to browse files on the mobile computer. ▶ PC to copy files to/from the mobile computer. ▶ PC to back up the files on the mobile computer.

Note ActiveSync isn't available with serial cable but USB cable only, and data stored on external storage (the SD card) cannot be synchronized.

See [ActiveSync Actions to Take](#) that details each aforesaid service.

1ST USB SYNC

This section will guide you to USB syncing. For Bluetooth syncing, see [Bluetooth ActiveSync](#).

To connect ActiveSync using USB:

- 1) Download the right syncing tool as described in [Syncing Tools](#) and install it on your PC.
- 2) Connect the mobile computer and your PC as described in [Use Cable](#) or [Use Cradle](#).
- 3) On the mobile computer, make sure ActiveSync is enabled. Check by Start screen |

Settings | Connections | USB connections  .

- 4) On your PC, run the syncing program.

ActiveSync should detect the mobile computer. **Sync Setup Wizard** launches and prompts to set up "[Sync Partnership](#)" between two computers

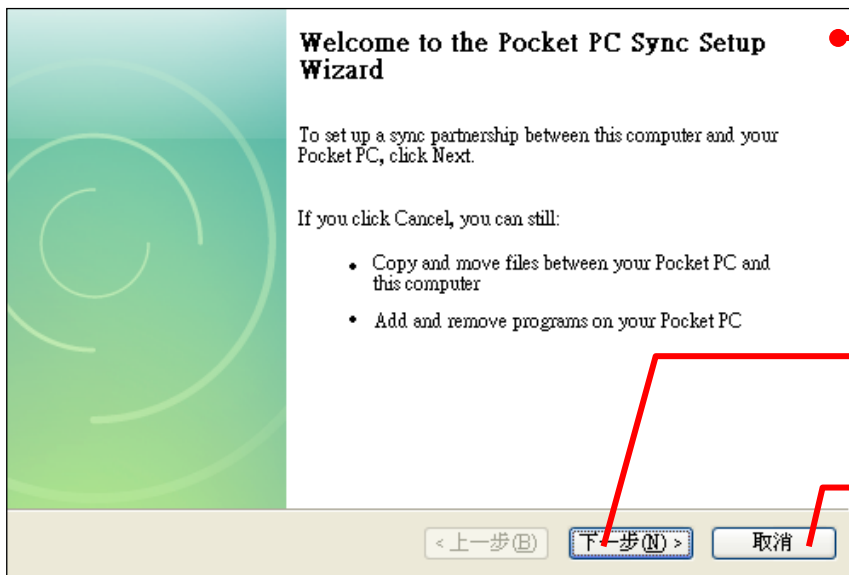

ActiveSync **Sync Setup Wizard** opens.

Press **Next** to set up "Synchronization Relationship".

Press **Cancel** to create "Temporary Relationship" by which the mobile computer works as a "guest" to the PC.

- 5) Press **Next** button for "Synchronization Relationship", or press **Cancel** button for "Temporary Relationship" if you don't plan to connect to the PC on a regular basis.

If you have pressed **Next**, follow the onscreen instructions to go through the setup of "Synchronization Relationship". Once setup finishes, ActiveSync opens showing "Synchronizing". Two computers are synchronized.

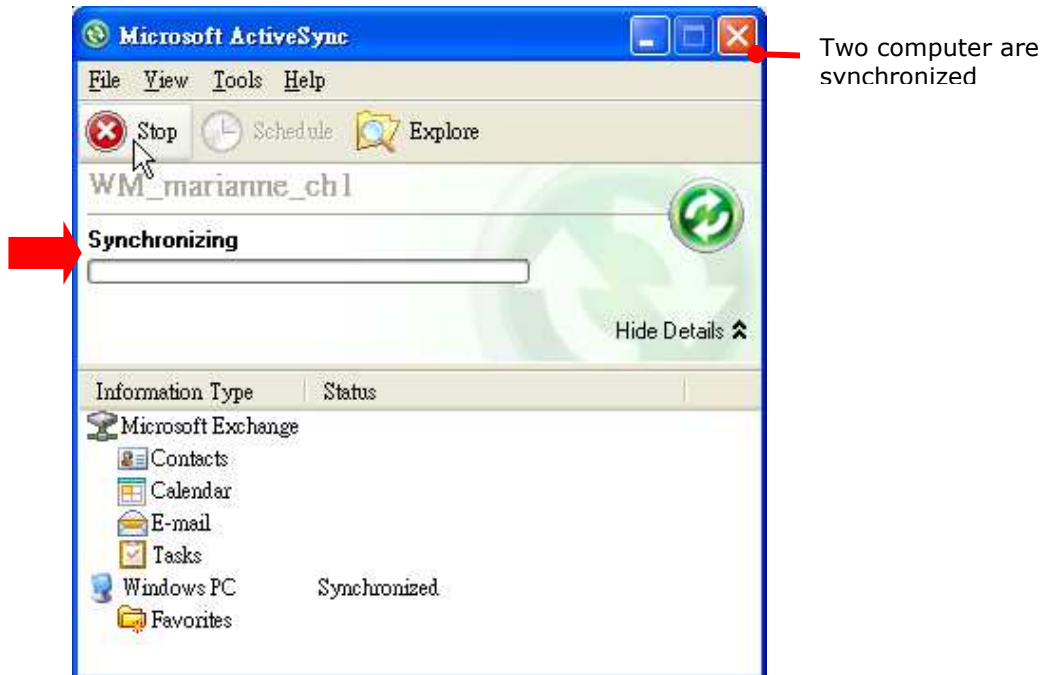

OR

If you have pressed **Cancel**, Microsoft ActiveSync opens showing "Guest" and "Connected". Two computers are connected.

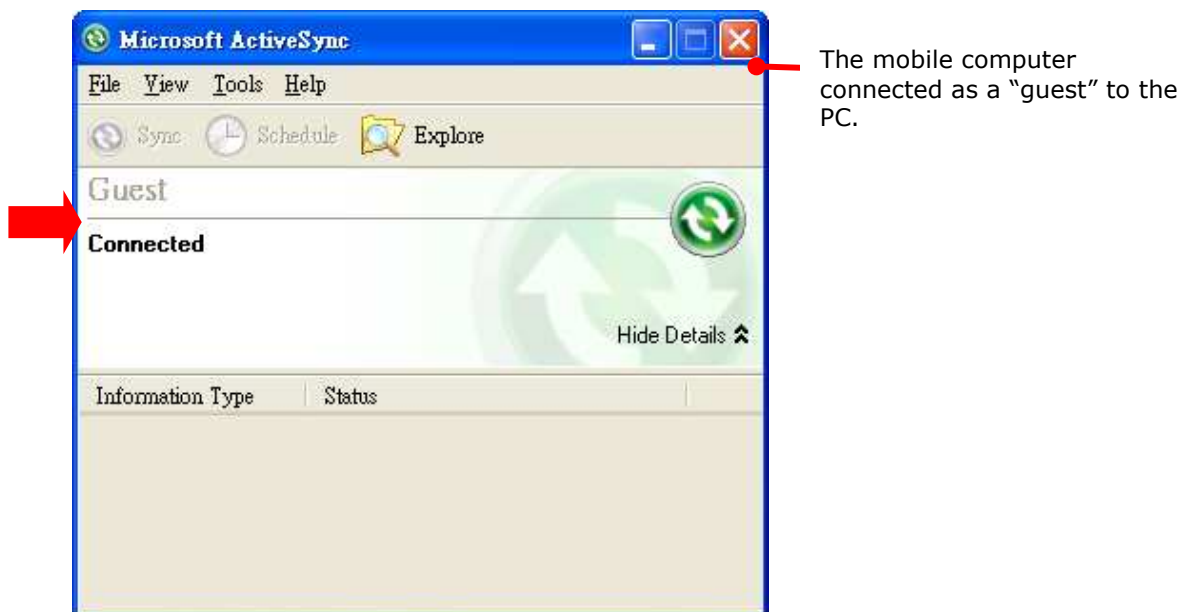

DISCONNECT USB ACTIVESYNC

To disconnect USB ActiveSync:

- 1) On your PC, open ActiveSync by double-clicking its icon  in the notification area. ActiveSync opens.
- 2) From the menu bar, click **File | Connection Settings**.
[Connection Settings] window opens.
- 3) Deselect **Allow USB connections**.
- 4) Press the **OK** button to apply the change and quit setting.
So when you plug your mobile computer the next time, it still gets charged but ActiveSync won't attempt to synchronize with it.

To disconnect Bluetooth syncing, see [Disconnect Bluetooth ActiveSync](#).

ACTIVESYNC ACTIONS TO TAKE

Once "Synchronization Relationship" or "Temporary Relationship" is up between two computers, a variety of actions can be taken to enhance the resources sharing between them as previously mentioned in [Sync Partnership](#).

In summary, "Synchronization Relationship" outshines "Temporary Relationship" by being capable of syncing Microsoft Office Outlook data. However "Temporary Relationship" provides satisfactory file sharing if you don't want to synchronize information.

See the following to know what actions to take with ActiveSync:

CHANGE MICROSOFT OFFICE OUTLOOK DATA TO SYNCHRONIZE

Note this is for "Synchronization Relationship" only.

In default state, "Synchronization Relationship" doesn't synchronize all Microsoft Office Outlook data but only a limited amount between two computers in order to save storage on the mobile computer. You can change the amount of information to synchronize:

- 1) On your PC, from the menu bar of ActiveSync, select **Tool | Options**.

ActiveSync's [Settings] window opens showing Options tabbed page.



- 2) Select an information type to synchronize, and deselect an information type to stop synchronizing.
- 3) Press OK button to save the change and quit setting.

Note you can also change the information to synchronize on the mobile computer in that you have to disconnect ActiveSync first as mentioned in [Disconnect USB ActiveSync](#) or [Disconnect Bluetooth ActiveSync](#) and then tap ActiveSync's "Menu" command  on [Softkey bar](#) and tap **Options**.

ADD/REMOVE PROGRAMS

Note basically the applications to be installed to the mobile computer need to be installed on your PC first. So download the application programs to your PC first and install them on your PC so they can be installed onto the mobile computer later.

Many application programs are installed in different ways. Read their installation guides or documentation to know how they are installed. If you are installing an application that cannot be installed on your PC first, try to install it right from the mobile computer, see [Download & Install Applications](#) for more details.

To install an application on the mobile computer:

- 1) Connect two computers as described in [Use Cable](#) or [Use Cradle](#).
- 2) Sync two computers as described in [1st USB Sync](#).
- 3) On the PC, from the menu bar of ActiveSync, select **Tools | Add/Remove Programs**.

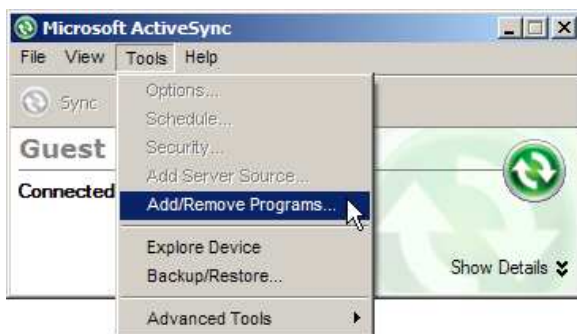

ActiveSync starts to search for the application programs installed on your PC and opens its [Add/Remove Programs] dialog which lists those found. Each entry comes with a check box on the left. An unchecked box means the program is yet to install to the mobile computer while a checked one means an installed program.

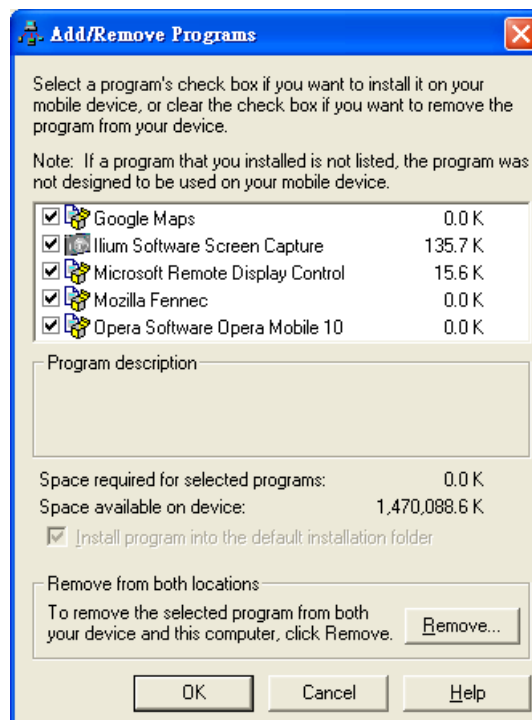

- 4) Select the application program(s) to install to the mobile computer, and deselect the application program(s) to uninstall from the mobile computer.
- 5) Hit the **OK** button.

ActiveSync proceeds to install programs and/or remove programs to/from the mobile computer.

- 6) Follow the onscreen instructions on both your PC and the mobile computer to proceed.

Noteworthy facts:

- ▶ Normally the application program(s) downloaded from external resources are installed to the mobile computer's directory at **Mobile Device\Program Files**. However sometimes there are exceptions and it depends on the application.
- ▶ You can uninstall application(s) right by the mobile computer rather than by the PC. See [Uninstall Applications](#) for more details.
- ▶ If an installed application program isn't listed among the installed ones, browse for it using File Explorer . Tap & hold it, and select **Delete** from the context menu that pops up.

ADD APPLICATION SHORTCUTS TO START SCREEN

ActiveSync features "Explore" to add an application shortcut to Start screen where it is easier to launch the application.

To add an application shortcut to Start screen:

- 1) Connect two computers as described in [Use Cable](#) or [Use Cradle](#).
- 2) Sync two computers as described in [1st USB Sync](#).
- 3) On the PC, from ActiveSync's menu bar, select **Tools | Explore Pocket PC**, or from its toolbar, press **Explore**  button.

The mobile computer's internal storage's root directory "**Mobile Device**" opens presenting a few folders (and files).

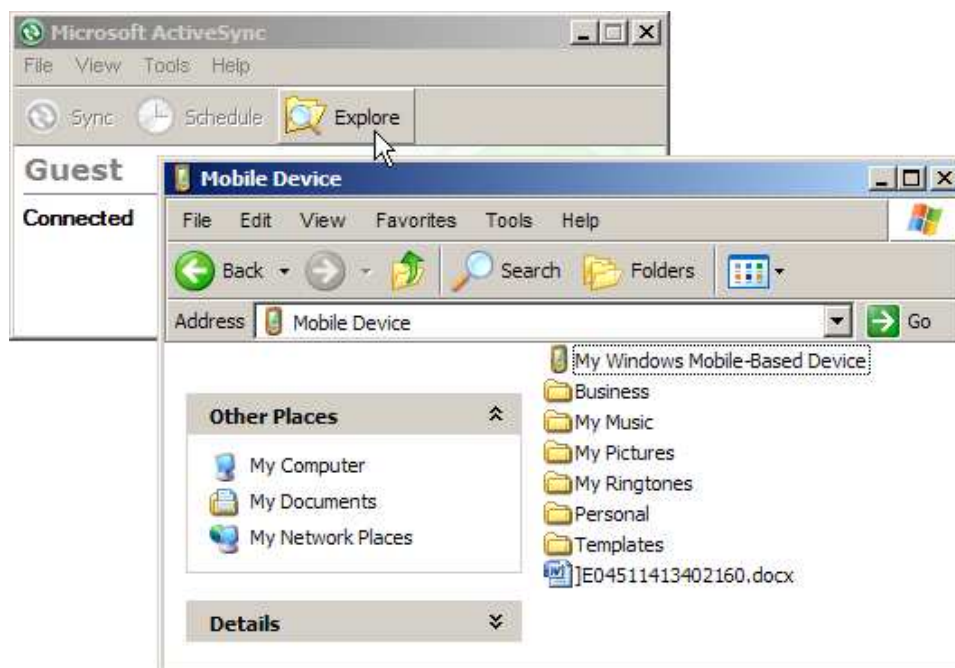

- 4) Double-click **My Windows Mobile-Based Device**  .
My Windows Mobile-Based Device opens.
- 5) Double-click **Program Files**.
Program Files folder opens. This is where the downloaded applications are normally installed on the mobile computer's local storage.
In the folder, each sub-folder stores an application.
- 6) Open the folder of the application to create shortcut for.
- 7) Find the executable file of that application. Right-click on it and select **Copy** from the context menu that comes up.
The executable file is copied.
- 8) Browse for **My Windows Mobile-Based Device\Windows\Start Menu\Programs**.
Programs folder opens.
- 9) Right-click any vacancy in the folder and select **Paste shortcut** from the context menu that comes up.
A shortcut to the application is added to Start screen.

Note: You can also copy & paste by the sequence **Create Shortcut -> Cut -> Paste**.

You can also add an application shortcut to Start screen right by the mobile computer. See [Add Items to Start Screen](#) for more details.

ADD FILE SHORTCUTS TO START SCREEN

ActiveSync features "Explore" to add to Start screen a shortcut to some local file so it is accessible more easily.

To add a file shortcut to Start screen:

- 1) Connect two computers as described in [Use Cable](#) or [Use Cradle](#).
- 2) Sync two computers as described in [1st USB Sync](#).
- 3) On the PC, from ActiveSync menu bar, select **Tools | Explore Pocket PC**, or from its toolbar, press **Explore**  button.
The mobile computer's internal storage root directory "**Mobile Device**" opens presenting a few folders.
- 4) Browser for the file to create shortcut for.
- 5) Right-click on the file and select **Copy** from the context menu that comes up.
- 6) Browse for **My Windows Mobile-Based Device\Windows\Start Menu\Programs**.
Programs folder opens.
- 7) Right-click any vacancy in the folder and select **Paste shortcut** from the context menu that comes up.
A shortcut to the file is added to Start screen.

Note: You can also copy & paste by the sequence **Create Shortcut -> Cut -> Paste**.

You can also add a file shortcut to Start screen right by the mobile computer. See [Add Items to Start Screen](#) for more details.

REMOVE SHORTCUTS FROM START SCREEN

Note the inherent shortcuts aren't removable. Only the added shortcuts are removable.

To remove an added shortcut from Start screen, simply use ActiveSync's **Explore**  to delete the shortcut from **My Windows Mobile-Based Device\Windows\Start Menu\Programs** folder.

You can also remove an added shortcut from Start screen right by the mobile computer. See [Remove Items from Start Screen](#) for more details.

CREATE NEW FOLDERS

To create a new folder on the mobile computer:

- 1) Connect two computers as described in [Use Cable](#) or [Use Cradle](#).
- 2) Sync two computers as described in [1st USB Sync](#).

On the PC, from ActiveSync menu bar, select **Tools | Explore Pocket PC**, or from its toolbar, press **Explore**  button.

The mobile computer's internal storage root directory "**Mobile Device**" opens presenting a few folders (and some files).

- 3) Browse where you want to create a folder.
- 4) Right-click any vacancy there.

Context menu opens

- 5) Select **New Folder**.

A new folder is created.

BACKUP DATA

To best protect your work, back up regularly the data on your mobile computer. Manually back up using ActiveSync by either "Synchronization Relationship" or "Temporary Relationship" with simple copy & paste to back up files to your PC.

USB PASS-THROUGH NETWORKING

ActiveSync supports "Pass-Through Networking" whereby the mobile computer networks using your PC's data connection.

For security, disable the network bridging on the PC, especially the bridging to a Remote NDIS adapter. For more information on network bridging, see Windows Help on the PC.

After sync partnership is up between the mobile computer and your PC:

- 1) On your PC, from the menu bar of ActiveSync, select **File | Connection Settings**.
[Connection Settings] window opens.
- 2) For **This computer is connected to**, select a network which your PC should connect to when passing through ActiveSync. Options are:

Option	Description
Automatic	Auto-detects proxy <ul style="list-style-type: none">▶ This option detects if a proxy should be used when passing connections through the PC. If yes, configure the proxy on the mobile computer.▶ This option best suits connecting to a PC (laptop) that may be used at home (with no proxy), as well as to a corporate network (with proxy).
Work Network	Always uses proxy <ul style="list-style-type: none">▶ This option assumes a proxy should be used when passing connections through the PC, and uses whatever proxy is already configured on the mobile computer.▶ This option best suits connecting to a PC that is always on corporate network.
The Internet	Never uses proxy <ul style="list-style-type: none">▶ This option assumes no proxy is necessary when passing connections through the PC.▶ This option best suits connecting to a PC connected directly to the Internet through ISP (at home)

- 3) Select **Open ActiveSync when my device connects**.
- 4) Hit **OK** button to apply the change and quit setting.

To pass-through network using Bluetooth, see [Bluetooth Pass-through Networking](#).

Compare [USB Internet Sharing](#).

CHARGING & COMMUNICATION CRADLE

The direct Charging & Communication Cradle is developed for what its name announces. It isn't provided bundled but an accessory to opt for. This cradle saves you from the trouble of perpetual plugging and unplugging USB/serial cable.

This cradle comes with an additional station for charging a spare battery. It also features an USB host connector to expand the connectivity to hardware peripherals.

USE CONVERTER

The cradle features a converter to dock the mobile computer whether gripped or ungripped. Installed with converter, the cradle seats a ungripped mobile computer.

To use converter:

- 1) Place converter onto cradle.
- 2) Click the converter carefully in place.
- 3) Check the rear of cradle. Make sure converter is bolt-locked.

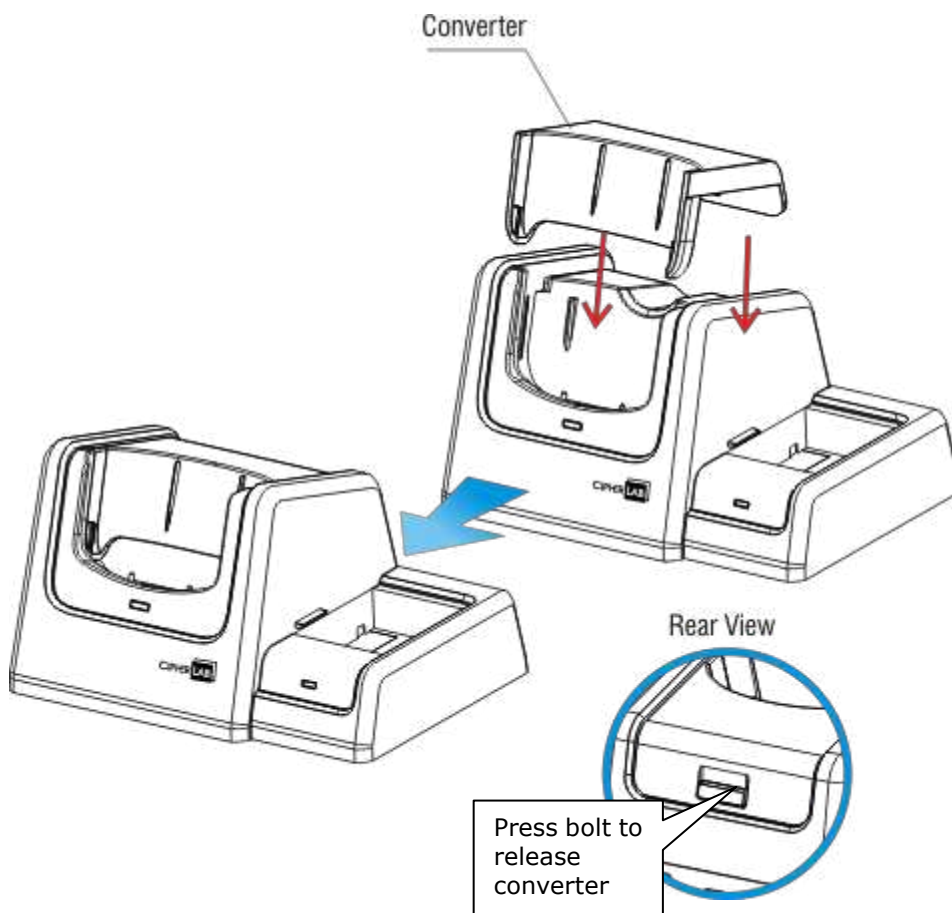

Figure 13: Use Cradle Converter

OVERVIEW

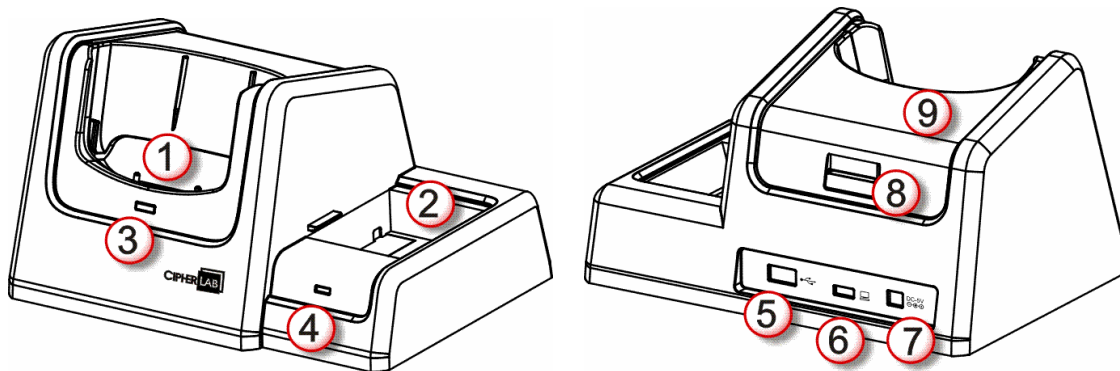

Figure 14: Cradle Overview

Number	Description								
1	Main charging station								
2	Spare battery charging station								
3	Main charging station status LED. ▶ This status LED lights on green when external power is connected.								
4	Spare battery charging station status LED. ▶ This status LED delivers the following conditions:								
	<table border="1"> <thead> <tr> <th>Status</th> <th>Description</th> </tr> </thead> <tbody> <tr> <td>Green on</td> <td>Spare battery fully charged.</td> </tr> <tr> <td>Red slow blinking</td> <td>Spare battery being charged.</td> </tr> <tr> <td>Red fast blinking</td> <td>Charging error. Spare battery is defective or out of charging temperature range, or spare battery's contact with charging station is imperfect.</td> </tr> </tbody> </table>	Status	Description	Green on	Spare battery fully charged.	Red slow blinking	Spare battery being charged.	Red fast blinking	Charging error. Spare battery is defective or out of charging temperature range, or spare battery's contact with charging station is imperfect.
Status	Description								
Green on	Spare battery fully charged.								
Red slow blinking	Spare battery being charged.								
Red fast blinking	Charging error. Spare battery is defective or out of charging temperature range, or spare battery's contact with charging station is imperfect.								
5	USB Host connector (Standard A Host)								
6	USB Client connector (Micro-B)								
7	Power jack								
8	Converter lock bolt. ▶ To release converter, press this bolt.								
9	Converter (for ungripped mobile computer)								

Note: For the mobile computer's charging status, check the status LED on the mobile computer.

PISTOL GRIP

As an accessory to opt for, the Pistol Grip is a snap-on handle that gives the mobile computer not only gun form factor but also trigger capability for intensive scanning.

INSTALL PISTOL GRIP

Slide the terminal into pistol grip until it clips in place.

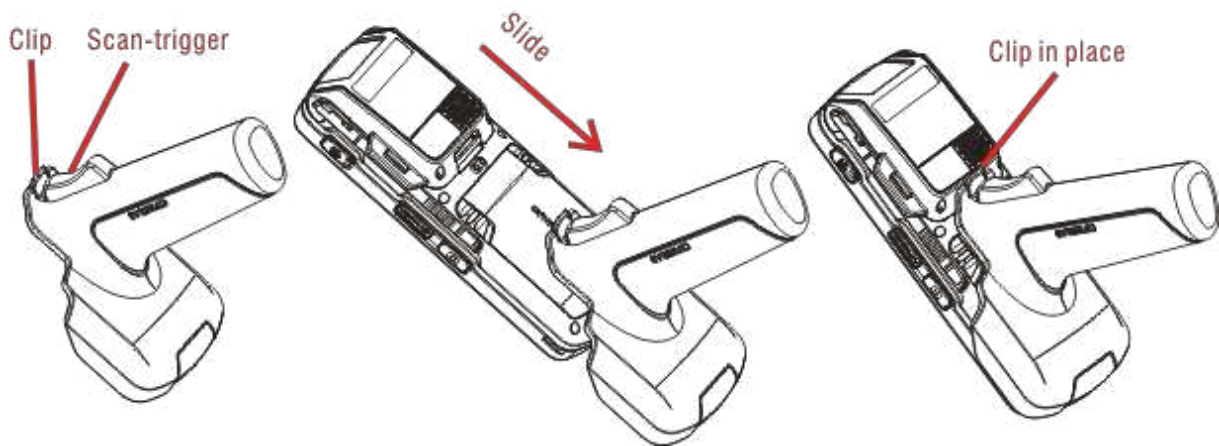

SCAN

To scan using Pistol Grip:

- 1) Launch scan engine(s) by running one of the reader utilities on the mobile computer.
- 2) Aim the mobile computer's scan window at the barcode to read.

OR

Tap (slightly contact) the mobile computer's scan window with the RFID tag to read.

- 3) Pull the trigger on Pistol Grip.

UNINSTALL PISTOL GRIP

Pull back the clip while at the same time withdraw Pistol Grip.

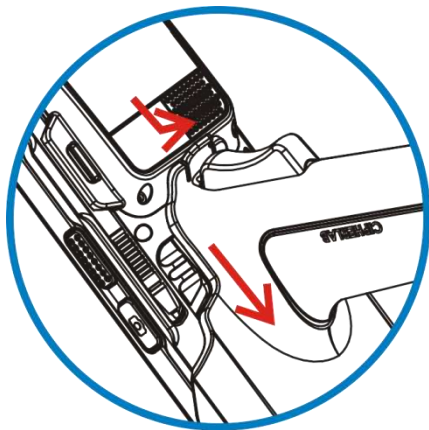

AUDIO PLAYBACK

Use a headset for audio playback and hands-free telephone communication.

The headset jack (3.5 mm DIA) is built up on one side of the mobile computer and sealed with a hinged rubber. Open the rubber to reveal the headset jack. Plug the connector of your headset to the jack.

Bluetooth headsets are supported to deliver better mobility. See [Use Bluetooth](#).

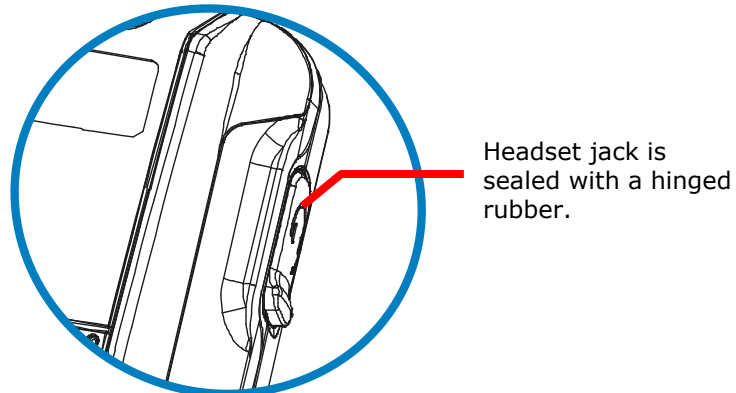

Figure 15: Audio Playback

VOLUME CONTROL

The mobile computer has two volume control facilities – the physical volume rocker perching on the waist of the mobile computer and the onscreen volume gauges featured by the O.S.

The physical rocker controls the system volume (media playback and event/notification sounds) and in-call volume. The onscreen gauge bests the physical rocker by adjusting phone ringer volume additionally.

When either the system volume or phone ringer volume is enabled, the O.S. shows an icon on [Title Bar](#); otherwise it shows an . See the table after the break for a summary.

Volume Control	System volume	Ringer volume	In-call volume
Physical Volume Rocker	Yes	No	Yes
Onscreen Volume Gauge	Yes	Yes	Yes
Title bar Volume Icons	Yes	Yes	No

PHYSICAL VOLUME ROCKER

Use physical volume rocker to turn up and down system volume and in-call volume. Note this volume rocker doesn't adjust phone ringer volume, which is only controllable by an onscreen volume gauge. And in-call volume is only adjustable when a call is ongoing. See also [Options during A Call](#).

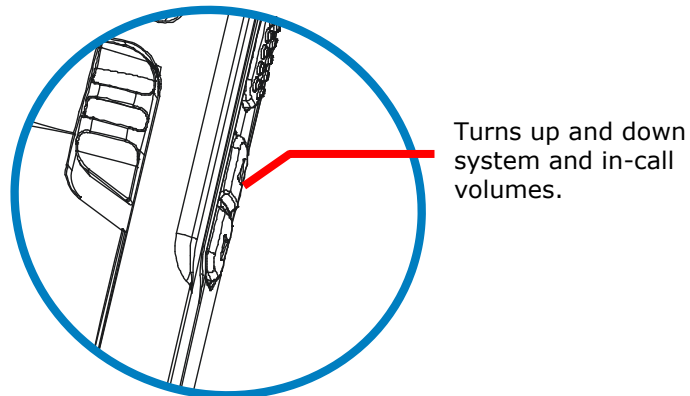



Figure 16: Physical Volume Rocker

ONSCREEN VOLUME GAUGES

The onscreen volume gauges adjust all three of system, phone ringer and in-call volumes. To adjust any of them:

- 1) Tap Title bar at the top of the screen.
A horizontal drop-down bar opens.

- 2) Tap the volume icon .

[Volume] dialog opens presenting the gauges for system volume and phone ringer volume. Three radio buttons [On], [Off] and [Vibrate] are featured on the right. Select [On] or [Off] to enable or mute both volumes while selecting [Vibrate] mutes the phone ringer and enables phone vibrate.

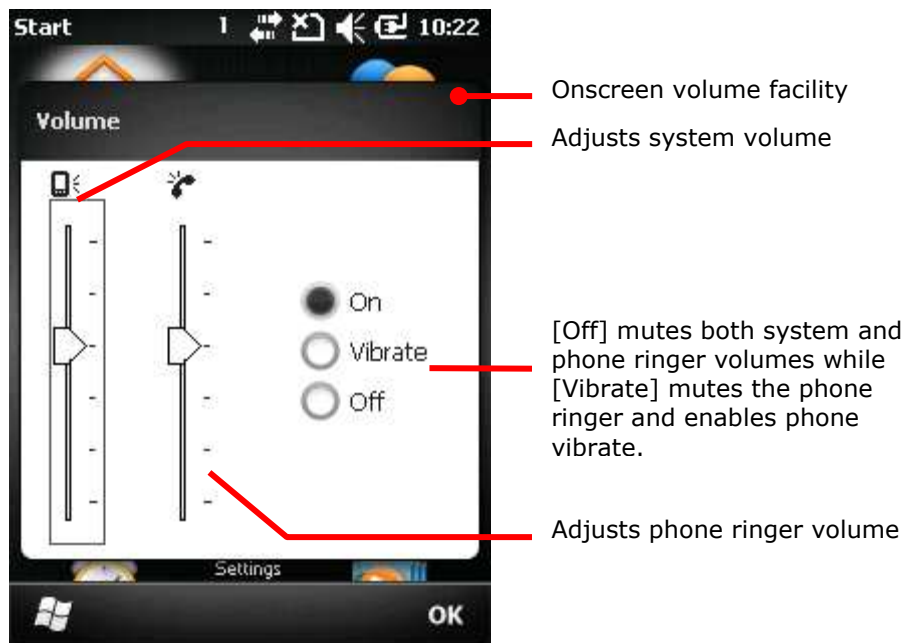

- 3) Make the setting that meets your needs.

Note the in-call volume gauge is only available when a call is ongoing. See [Options during A Call](#) for more details.

DATA CAPTURE

Although highly converged, the mobile computer is a dedicated barcode/RFID reader. The mobile computer ships with either a (laser) 1D reader or 2D imager and sometimes plus an RFID reader. A number of symbologies and RFID tags are supported and data about them can be decoded and collected.

A high-specced 5.0 mega-pixel camera is also recessed on the rear of the mobile computer to capture images to better meet your field applications.

Done with the data collection, the mobile computer outputs the collected data to the host computer so data storage, advanced data analysis and more special services can be performed.

You will learn how to collect data with reader modules in this chapter while collecting images with camera is detailed in the following chapter [Camera](#).

IN THIS CHAPTER

Launch Reader Module(s)	58
Read Printed Barcodes & RFID Tags	59
Configure Reader(s).....	60

LAUNCH READER MODULE(S)

The mobile computer reads printed barcodes and RFID tags. The reader modules can be a (laser) 1D reader or a 2D imager plus an RFID reader, and never be a (laser) 1D reader plus a 2D imager. The two don't coexist on the mobile computer. They rule out each other since they both read barcodes.

It relies on CipherLab's *ReaderConfigMobile.exe* to launch the reader module(s). *ReaderConfigMobile.exe* is provided bundled with the mobile computer. Run it to launch reader module(s).

To launch reader module(s):

- 1) Open Start screen, tap **CipherLabUtilities**  .
CipherLabUtilities opens.

- 2) Tap **Reader Configuration**  .

ReaderConfigMobile.exe opens in context with the available reader module(s) on board the mobile computer.

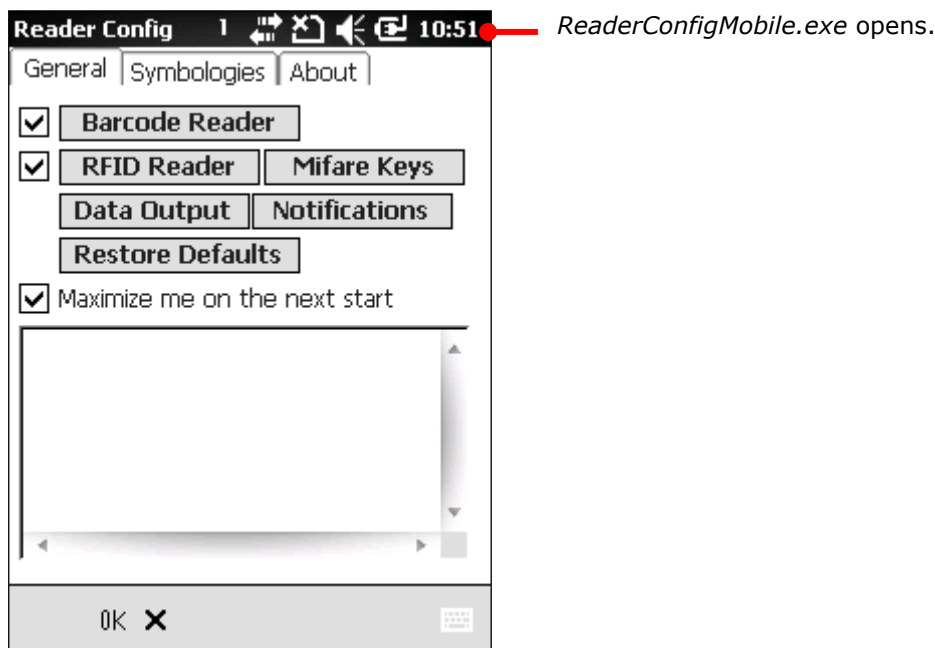

The mobile computer readies to read printed barcodes (and RFID tags).

- 3) Proceed to collect data as described in [Read Printed Barcodes & RFID Tags](#).

OR

If you want to, configure the reader module(s) first as described in [Configure Reader\(s\)](#) before starting collecting data.

READ PRINTED BARCODES & RFID TAGS

Before you start out collecting data, configure the reader module(s) using *ReaderConfigMobile.exe* as described in [Configure Reader\(s\)](#), or skip the configuration and go straight to collect data.

To collect data:

- 1) Launch the reader module(s) as described in [Launch Reader Module\(s\)](#).
- 2) Configure the reader module(s) if you want to.
- 3) Run a text editor on the mobile computer or connect the mobile computer to a remote computer so there is somewhere to admit the decoded data.
- 4) Find the scanning window on the top of the mobile computer. Point it at the printed barcode to read while holding the mobile computer steady a few inches from the barcode.

OR

Find the scanning window on the top of the mobile computer. Tap (slightly contact) the scanning window with the RFID tag.

- 5) Press the physical SCAN key (or either side trigger) on the mobile computer.
The scanning light beams to read the printed barcodes, or RFID tags are read.
The scanning light goes off upon data decoding or decoding timeout.



Figure 17: Reading Printed Barcodes

CONFIGURE READER(S)

ReaderConfigMobile.exe is meant to launch and configure reader modules. Use it to create the application that best suits your needs.

To open *ReaderConfigMobile.exe*:

- 1) On Start screen, tap **CipherLabUtilities**  .
CipherLabUtilities opens.

- 2) Tap **Reader Configuration**  .

ReaderConfigMobile.exe launches in context with the reader module(s) on board the mobile computer. The software opens showing **General** tabbed page while hiding **Symbologies** and **About** tabbed pages.

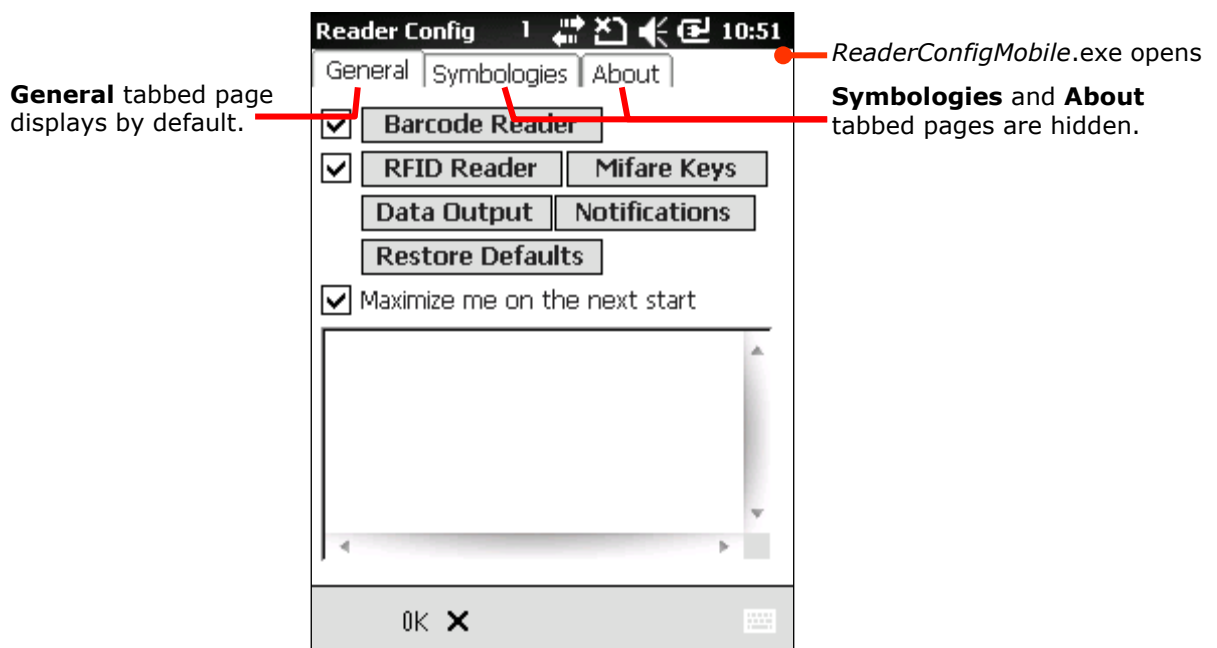

The following will guide to all aforesaid tabbed pages.

GENERAL TABBED PAGE

General tabbed page is where all reader settings are accessed from except for symbologies settings. **General** tabbed page presents settings by rectangle GUI buttons and check boxes. Each GUI buttons can be tapped to open a setting page. **General** tabbed page also features a field to deliver the result of test-scan.

To open **General** tabbed page:

- 1) Launch *ReaderConfigMobile.exe* as described in [Configure Reader\(s\)](#).
The software launches showing **General** tabbed page.

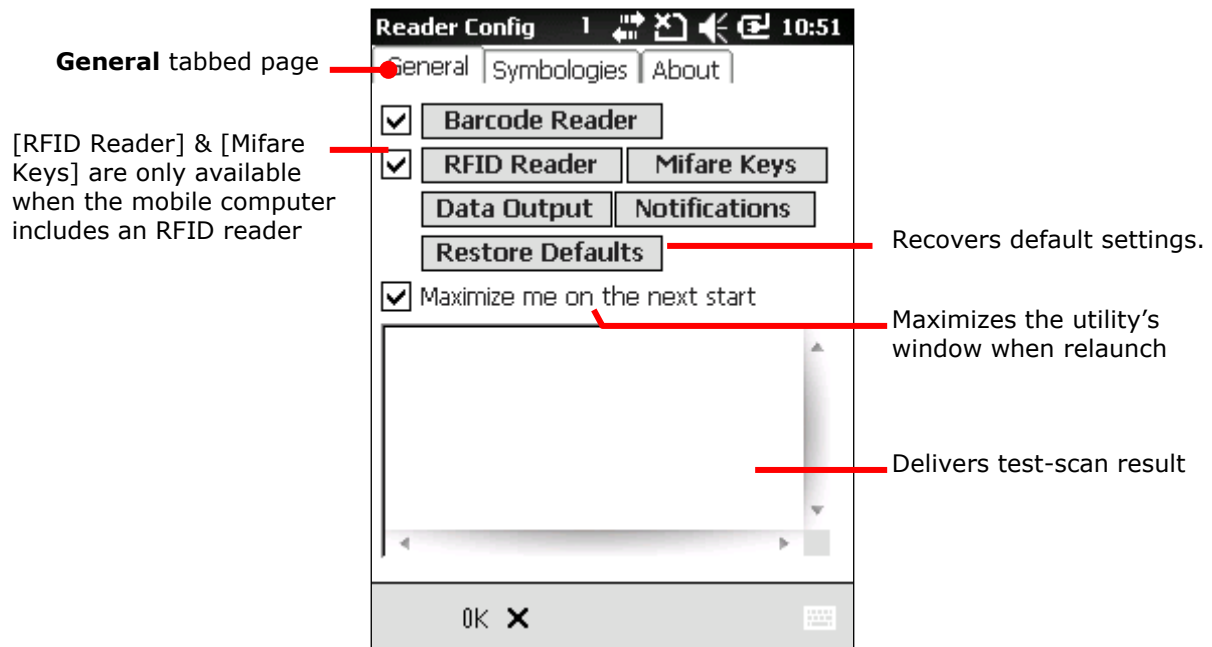

The facilities on **General** tabbed page are tabulated as follows:

Setting	Facility	Description	Default
Barcode Reader	Check box	Enables/disables 1D (laser) reader or 2D imager	Selected
	GUI button	Opens barcode reader setting page	--
RFID Reader	Check box	Enables/disables RFID scan engine	Selected
	GUI button	Opens a page that sets RFID reading.	--
Mifare Keys	GUI button	Opens a page that changes key A and B to read/write RFID-tags.	--
Data Output	GUI button	Opens a page that sets where and how to output decoded data.	--
Notifications	GUI button	Opens a page that sets how to notices users of good read.	--
Restore Defaults	GUI button	Recovers default settings.	--
Maximize me on the next start	Check box	Enlarges the window to full-screen size when the software relaunches.	Selected
Input Field		Delivers user's test-scanned data.	--

BARCODE READER

Barcode Reader features a check box and a GUI button on **General** tabbed page. The check box is selected by default. Deselect it to disable the 1D (laser) reader or 2D imager, which is occasionally needed when an RFID reader coexists on the mobile computer and you only want the RFID tags to be read, lest printed barcodes should be read and decoded.

The **Barcode Reader** GUI button can be tapped to open a setting page that configures your barcode reading.

To open **Barcode Reader** setting page:

- 1) Open **General** tabbed page as described in [General tabbed page](#).

General tabbed page opens.

- 2) Tap **Barcode Reader** button.

Barcode Reader setting page opens.

Featured settings are different for 1D (laser) reader and 2D imager:

1D (laser) reader settings

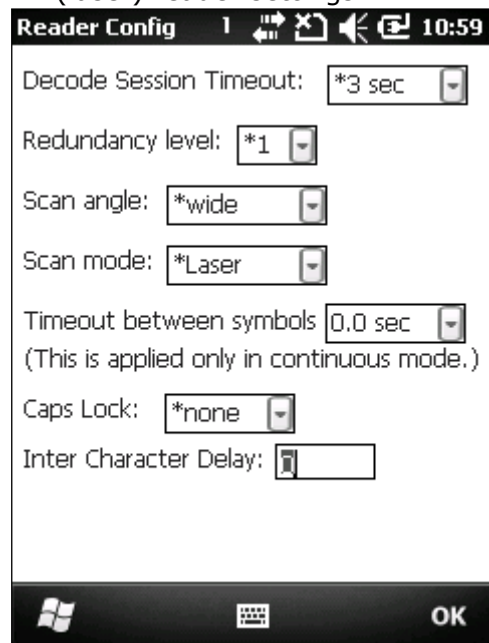

2D imager settings

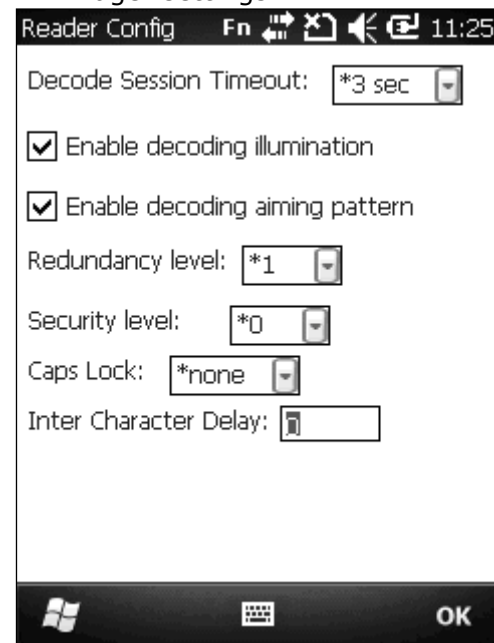

1D (LASER) READER SETTING

Setting	Description	Default
Decode Session Timeout	Defines the maximum time for a decoding act. 1 through 9 sec configurable.	3 sec
Redundancy level	Sets how many successful readings should be done before a barcode can be decoded.	1
Scan angle	Sets the scan angle for laser scan engine.	Wide
Scan mode	Sets the reader's scanning behaviour. Options available are Continuous and Laser modes.	Laser

Timeout between symbologies	Sets the time for the barcode reader to resurrect its ability to once more decode a barcode it just decoded. ▶ Only available for Continuous mode.	1 sec
Caps Lock	Capitalizes the literal-characters among decoded data.	None
Inter Character Delay	Sets the delay time between each output character (by millisecond).	0

2D IMAGER SETTING

Setting	Description	Default										
Decode Session Time-out	Defines the maximum time for a decoding act. 1 through 9 sec are configurable.	3 sec.										
Enable decoding Illumination	Enables beaming a flash of light (internal LED) to aid reading a printed barcode.	Selected (Enabled)										
Enable decoding aiming pattern	Enables projecting a crosshair to aim at the printed barcode to read.	Selected (Enabled)										
Redundancy level	Sets how many successful readings should be done before a barcode can be decoded.	Level 1										
Security Level	<p>Sets the security level to ensure decoding accuracy considering the printed quality of the barcodes such as Code 128, Code 93, and UPC/EAN. The higher the level is, the more security is ensured. Options are:</p> <table border="1"> <thead> <tr> <th>Level</th> <th>Description</th> </tr> </thead> <tbody> <tr> <td>0</td> <td>With this default, the scan engine is aggressive enough to decode most "in-spec" barcodes.</td> </tr> <tr> <td>1</td> <td>Select this level if misdecodes have occurred. It fixes most misdecodes.</td> </tr> <tr> <td>2</td> <td>Select this level if Level 1 should fail to eliminate misdecodes.</td> </tr> <tr> <td>3</td> <td>Select this level if Security Level 2 should fail to prevent misdecodes. However, as this level actually impairs the decoding ability of scan engine, it'd be better to improve barcode's print quality if this level should be needed.</td> </tr> </tbody> </table>	Level	Description	0	With this default, the scan engine is aggressive enough to decode most "in-spec" barcodes.	1	Select this level if misdecodes have occurred. It fixes most misdecodes.	2	Select this level if Level 1 should fail to eliminate misdecodes.	3	Select this level if Security Level 2 should fail to prevent misdecodes. However, as this level actually impairs the decoding ability of scan engine, it'd be better to improve barcode's print quality if this level should be needed.	Level 0
Level	Description											
0	With this default, the scan engine is aggressive enough to decode most "in-spec" barcodes.											
1	Select this level if misdecodes have occurred. It fixes most misdecodes.											
2	Select this level if Level 1 should fail to eliminate misdecodes.											
3	Select this level if Security Level 2 should fail to prevent misdecodes. However, as this level actually impairs the decoding ability of scan engine, it'd be better to improve barcode's print quality if this level should be needed.											
Caps Lock	Capitalizes the literal-character among the decoded data.	None										
Inter Character Delay	Sets the delay time between each output character (by millisecond).	0										

RFID READER

When an RFID reader is detected, **RFID Reader** becomes available on [General tabbed page](#).

RFID Reader comes with a check box selected by default. Deselect it to disable the RFID reader on the mobile computer. This is occasionally needed when you only want to read printed barcodes, lest RFID tags should be read and decoded.

The **RFID Reader** GUI button can be tapped to open a setting page that tunes your RFID reading.

To open **RFID Reader** setting page:

- 1) Open **General** tabbed page as described in [General tabbed page](#). **General** tabbed page opens.
- 2) Tap **RFID Reader** button. **RFID Reader** setting page opens. It features two check boxes - **Read blocks** and **Write blocks** atop other settings.
- 3) Select **Read blocks** to read data from an RFID tag; or select **Write blocks** to write data to an RFID tag.

Selecting **Read blocks** or **Write blocks** renders different settings:

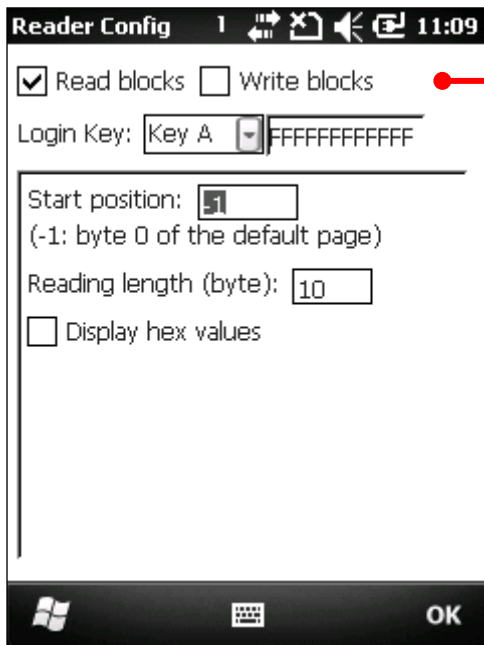

RFID Reader settings page (for read operation)

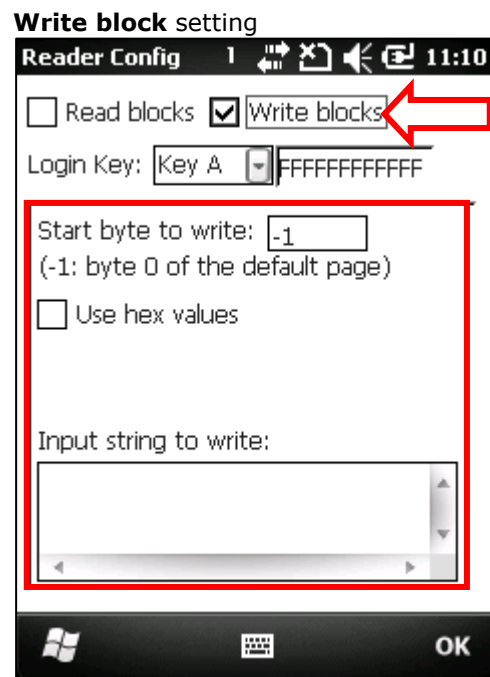
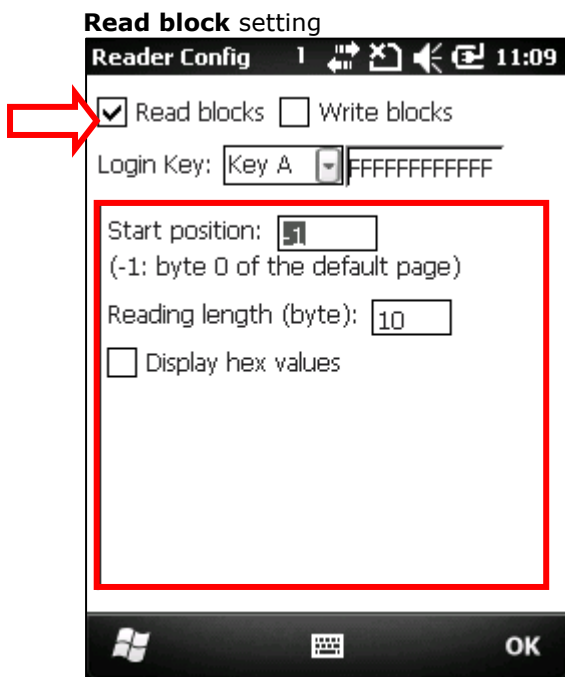

Featured settings are enumerated as follows:

READ BLOCKS SETTINGS

Setting	Descriptions	Default
Read blocks	Reads data from an RFID tag	Selected
Login Key	Shows what key A and key B currently is. <ul style="list-style-type: none"> ▶ Keys A and B are what the RFID reader module relies on to access (read or write) an RFID tag. In default state, both keys are a sequence of twelve "F" characters because they are Mifare tag's factory default. ▶ If necessary, modify these default keys by Mifare Keys setting. (See Mifare Keys.) 	Key A & FFFFFFFFFFFF
Start Position	Defines where to start reading data from.	-1 (default block, byte 0) <ul style="list-style-type: none"> ▶ See Appendix IV: RFID Tag Default Block.
Reading length (byte)	Defines how many bytes of data to read.	10
Display hex value	Displays decoded data in hex values. <ul style="list-style-type: none"> ▶ Generally the readable RFID data lies in user block. If the data to collect confides in a non-user block such as the lock block, select Display hex values lest the data to collect involves any invisible character. 	Deselected

WRITE BLOCKS SETTINGS

Setting	Descriptions	Default
Write blocks	Writes data to an RFID tag	Deselected
Login Key	Shows what key A and key B currently is. <ul style="list-style-type: none"> ▶ Keys A and B are what the RFID reader module relies on to access (read or write) an RFID tag. In default state, both keys are a sequence of twelve "F" characters because they are Mifare tag's factory default. ▶ If necessary, modify these default keys by Mifare Keys setting. (See Mifare Keys.) 	Key A & FFFFFFFFFFFF
Start byte to write	Defines where to start writing data to.	-1 (default block, byte 0) <ul style="list-style-type: none"> ▶ See Appendix IV: RFID Tag Default Block.
Use hex values	Writes data in hex values. <ul style="list-style-type: none"> ▶ Generally a RFID tag's writeable block is the user block. However, if the block to write is a non-user block such as the lock block, select Use hex 	Deselected

	values to write data in hex values lest the block to write involves any invisible character.	
Input string to write	Defines what to write. <ul style="list-style-type: none">▶ Note as different RFID tags may have different default blocks (also "pages"), and different amount of bytes and number of blocks. The data written is truncated to fit the blocks of the targeted RFID tag. Therefore part of the data may be discarded when it comes to the end of a block end.▶ See Appendix IV: HF RFID Reader to know RFID Tag Default Block.	--

Note: Refer to the specifications of the RFID tag to read for its memory organization.

MIFARE KEYS

Mifare Keys setting changes the security keys A and/or B for a Mifare tag's data block. Keys A and B are two keys that enable the RFID reader to access (read or write) a Mifare tag's data block.

To open **Mifare Keys** setting page:

- 1) Open **General** tabbed page as described in [General tabbed page](#).

General tabbed page opens.

- 2) Tap **Mifare Keys** button.

Mifare Keys setting page opens.

[Mifare Keys] setting

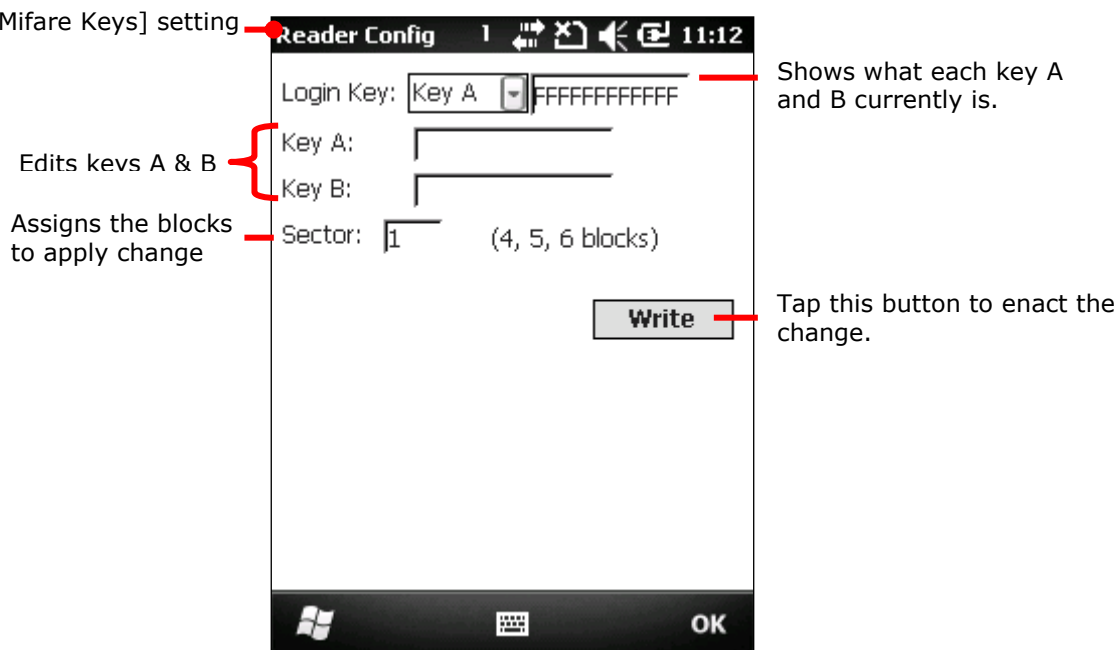

Settings	Descriptions	Default
Key A	Assigns new key A, which must be a hex string of 12 bytes. <ul style="list-style-type: none"> ▶ If it is the other key (key B) that you want to change, you still need to assign the current key A here to be able to enact the change. 	--
Key B	Assigns new key B, which must be a hex string of 12 bytes. <ul style="list-style-type: none"> ▶ If it is the other key (key A) that you want to change, you still need to assign the current key B here to be able to enact the change. 	--
Sector	Sets the blocks to apply the change.	1 (blocks 4, 5, & 6)

To perform change to key A and/or B:

- 1) Launch RFID reader as described in [Launch Reader Module\(s\)](#).

- 2) Open **Mifare Keys** setting page as mentioned in [Mifare Keys](#).
- 3) Configure which key to change, how it is changed to, and the block to apply the change as described in [Mifare Keys](#).
- 4) Tap (slightly contact) the mobile computer's scanning window with the RFID tag to write change to.
- 5) Tap **Write** button on **Mifare Keys** settings page.
Change is written to the RFID tag.

DATA OUTPUT

Data Output setting tweaks where and how to output decoded data.

To open **Data Output** setting page:

- 1) Open **General** tabbed page as described in [General tabbed page](#).
General tabbed page opens.
- 2) Tap **Data Output** button.
Data Output setting page opens.

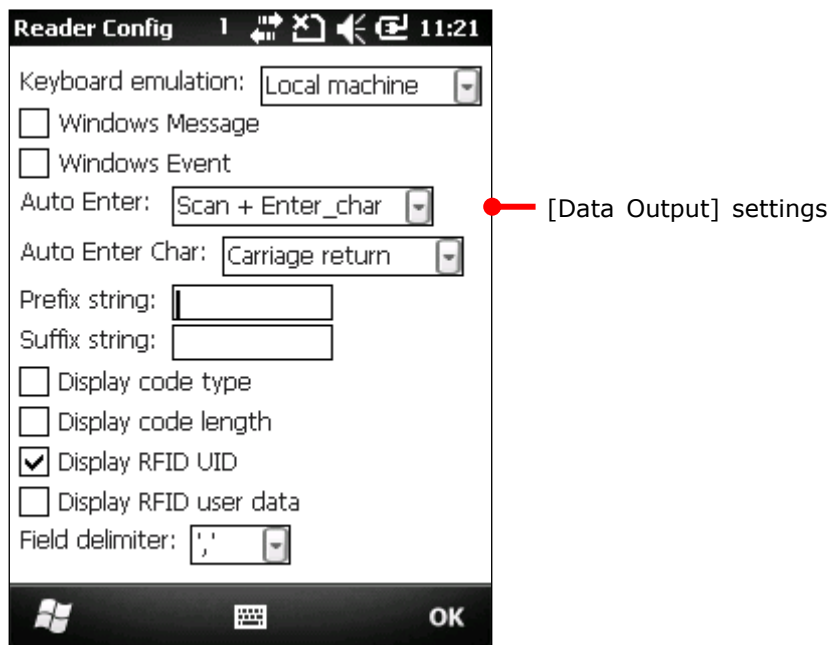

WHERE TO OUTPUT

The very first three settings featured are - **Keyboard emulation**, **Windows Message** and **Windows Event**. They control where the decoded data is output to.

Setting	Descriptions	Default
Keyboard emulation	<p>Treats decoded data as typed text and outputs it to the active application locally on the mobile computer or remotely on a computer afar. Options are:</p> <ul style="list-style-type: none"> ▶ None – Disables Keyboard emulation whereby decoded data won't be output. ▶ Local machine – Passes decoded data to the active application locally on the mobile computer. ▶ RDP server – Passes decoded data to the active application on the remote computer connected. (Note this option is unable to pass double-byte characters such as Big-5 or Unicode characters.) 	Local machine
Windows Message	<p>Outputs decoded data via Windows Message.</p> <ul style="list-style-type: none"> ▶ Intercept the decode message in your application. ▶ Call Windows API (ReadMsgQueue) in your application to retrieve decoded data. 	Deselected

Windows Event	Outputs decoded data via Windows Event. <ul style="list-style-type: none"> ▶ Intercept the decode event in your application. ▶ Call Windows API (ReadMsgQueue) in your application to retrieve decoded data. 	Deselected
---------------	--	------------

Note: (1) To know more about Windows Message and Windows Event, see CP50 programming guides. Sample programs are provided on request.
 (2) If you don't want to use *ReaderConfigMobile.exe*, a dynamic-link library (DLL) file is at your command.

HOW TO OUTPUT

After where to output is set, configure how to output decoded data, i.e. the "format" to present decoded data.

Setting	Description	Default
Auto ENTER	Adds an ENTER character before or after each scanning act. This function saves the trouble pressing [Enter] key to confirm each scan. Options are: <ul style="list-style-type: none"> ▶ No ▶ Scan + ENTER ▶ ENTER + Scan 	Scan + ENTER
Auto ENTER Character	Adds a key code before or after the decoded data. This setting is available only when [Auto ENTER] is enabled. Options are: <ul style="list-style-type: none"> ▶ None ▶ Carriage Return ▶ Tab ▶ Space ▶ Comma ▶ Semicolon 	Carriage Return
Prefix string	Affixes 0 to 10 characters to the left of the output data.	--
Suffix string	Affixes 0 to 10 characters to the right of the output data.	--
Display code type	Prefixes the output data with code type data.	Deselected (Disabled)
Display code length	Suffixes the output data with code length data.	Deselected (Disabled)
Display RFID UID	Outputs the UID of the RFID tag to read. <ul style="list-style-type: none"> ▶ setting available only when RFID reader is available 	Selected (Enabled)
Display RFID user data	Outputs the user data of the RFID tag to read. <ul style="list-style-type: none"> ▶ setting available only when RFID reader is available 	Deselected (Disabled)
Field delimiter	Sets the delimiter to separates a output data to pieces — <ul style="list-style-type: none"> ▶ For printed barcodes: This delimiter separates code type, decoded barcode data, and code length (if they are applicable.) ▶ For RFID tags: This delimiter separates UID and user data if both are applicable. 	' , ' (comma)

NOTIFICATIONS

Notification setting controls if a successful decoding is made known through audible, visible and/or tactile feedback.

To open **Notification** setting page:

- 1) Open **General** tabbed page as described in [General tabbed page](#).
General tabbed page opens.
- 2) Tap **Notification** button.
Notification setting page opens.

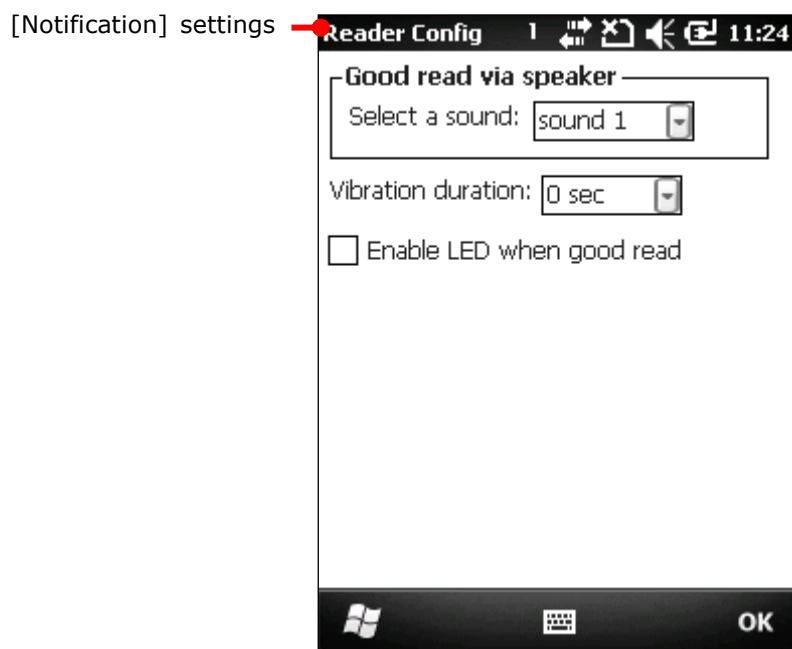

Featured settings are:

Setting	Descriptions	Default
Good read via speaker	Enables/disables speaker to sound for good read. Sounds 1 to 9 are configurable.	Enabled & Sound 1
Vibration duration	Enables/disables tactile feedback (vibration) for good read and sets duration. Configurable duration is 0 to 5 seconds.	0 sec (=disabled)
Enable LED when good read	Enables/disables the mobile computer's Green LED to light for good read. See also Status LED .	Deselected (= disabled)

RESTORE DEFAULTS

Tap **Restore Defaults** button to restore all settings to defaults.

SYMBOLOLOGIES TABBED PAGE

Symbologies tabbed page sets the symbologies to read, and enables/disables some feature(s) for a symbology to read such as:

- ▶ customize/transmit start/stop characters
- ▶ verify/transmit check digits,
- ▶ enable/disable addon digits
- ▶ convert to another symbology
- ▶ transmit symbology ID

To open **Symbologies** tabbed page:

- 1) Launch *ReaderConfigMobile.exe* as described in [Configure Reader\(s\)](#).
The software launches showing **General** tabbed page.
- 2) Tap **Symbologies** tab.
Symbologies tabbed page opens.

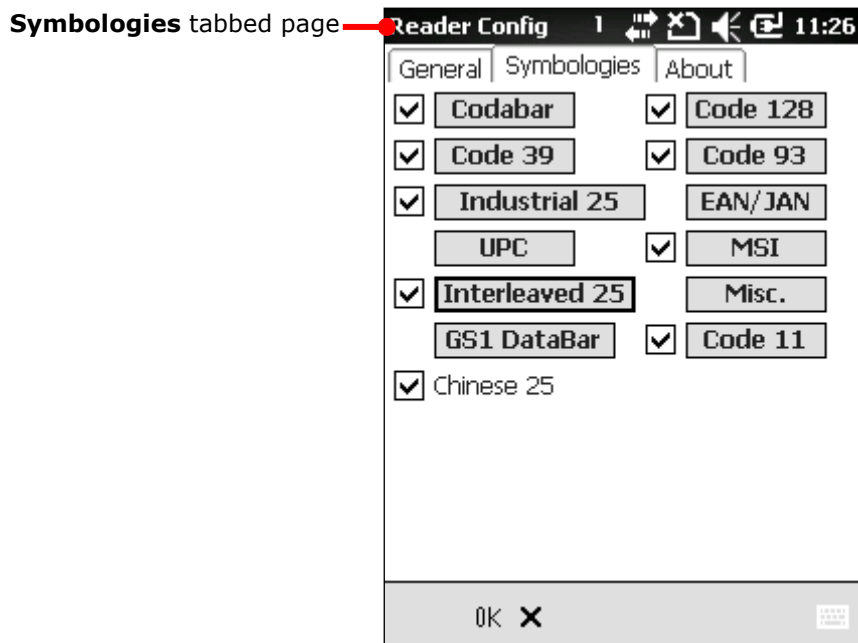

For the details about the featured settings, hit the links below:

- ▶ See Appendix II: 1D Laser [Symbology Settings](#).
- ▶ See Appendix III: 2D Imager [Symbology Settings](#).
- ▶ See Appendix IV: HF RFID Reader - [RFID Tag Default Block](#).

ABOUT TABBED PAGE

This tabbed page delivers the software version, developer info, and decoder hardware version

To open **About** tabbed page:

- 1) Launch *ReaderConfigMobile.exe* as described in [Configure Reader\(s\)](#).
The software launches showing **General** tabbed page.
- 2) Tap **About** tab.
About tabbed page opens.

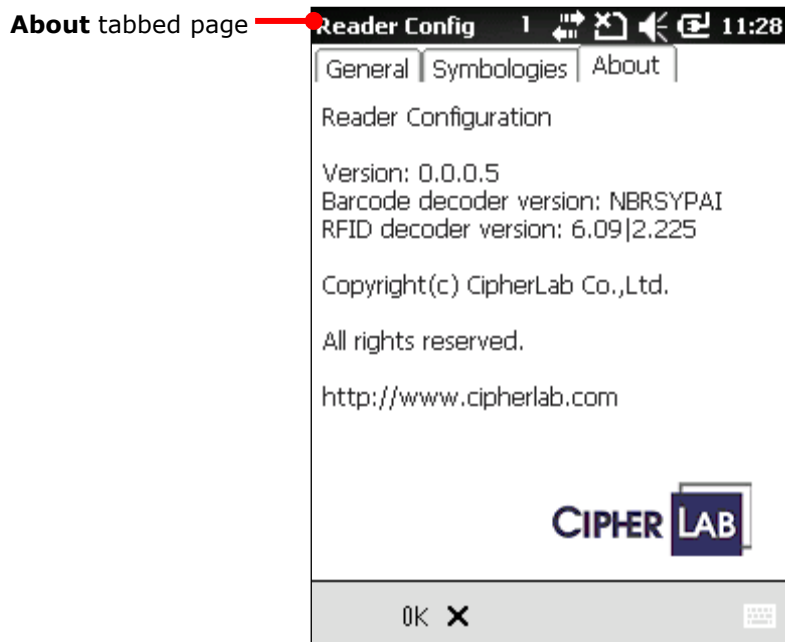

CAMERA

The mobile computer is adorned with a 5.0 mega-pixel camera that doubles as a camcorder. The O.S. provides a camera/camcorder application, which launches the camera, takes pictures, shoots videos and stores the works on the mobile computer's storage where they can be viewed, edited and output.

The camera/camcorder application provides users with satisfactory customization that is helpful for users' image capture for better documentation.

This chapter will guide you to use the camera.

IN THIS CHAPTER

Launch Camera	76
Take Pictures	77
Launch Camcorder	80
Shoot Video	81
Pictures & Videos.....	84

LAUNCH CAMERA

To launch the camera:

- 1) On Start screen, tap **Camera** .

OR

- 1) Simply press the physical camera shutter button.
Camera opens in landscape mode and readies to take pictures.

CAMERA SCREEN

Camera opens showing subject area on the screen with a few pieces of status info at the upper-left and date/time info at the upper-right.

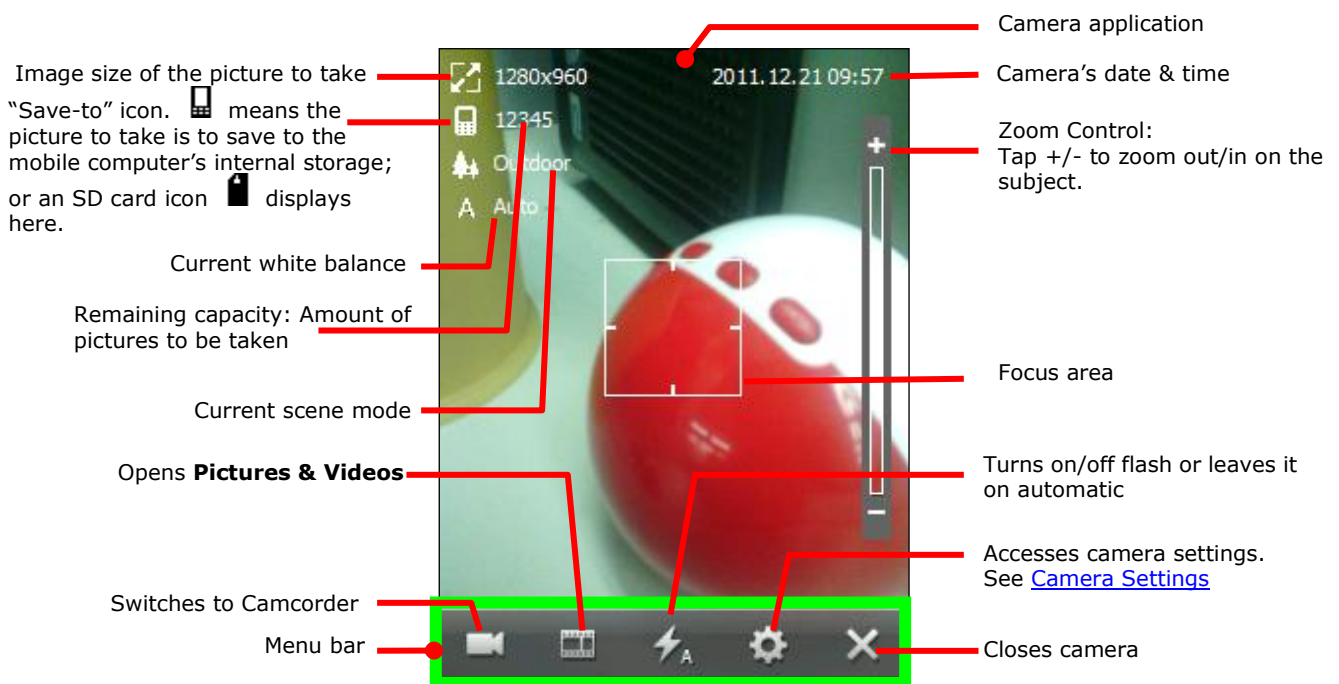



TAKE PICTURES

By default, pictures are taken with JPEG format and saves to the mobile computer's internal storage at **My Device\My Documents\My Pictures**. To change the default, see [Camera Settings](#).

To take a picture:

- 1) Turn on camera as described in [Launch Camera](#).

Camera opens in landscape mode and readies to take pictures.

In case menu bar doesn't show an  icon but an  icon, tap  icon to switch to camera.



- 2) Adjust the flash, picture quality and any other settings if you want to, or leave them on automatic. Tap  icon on menu bar to configure camera. See [Camera Settings](#).
- 3) Frame your object on the screen.
- 4) Press physical shutter button. (See [Overview](#).)

Camera proceeds to bring the subject into focus. Once it gets in focus, the focus indicator changes color and the camera takes a picture. A rotating  icon shows onscreen indicating the application is working on the picture.



Camera application is working on the picture

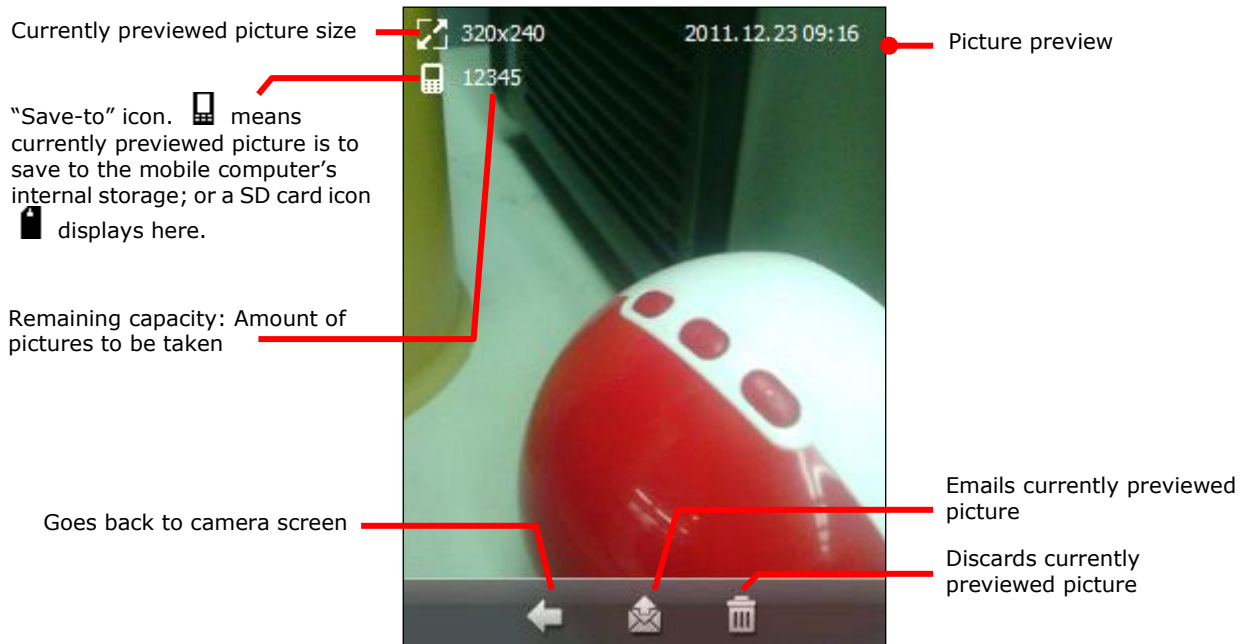

When the framed subject gets in focus, the focus indicator changes color.

If preview screen is enabled, the picture you just took displays for a moment for preview. Tap  to email the picture by the mobile computer’s data connections or tap  to discard it.

























CAMERA SETTINGS

Although the camera is a point-and-shoot type with automatic settings for quick shooting of photographs, it supports changing sharpness, contrast, white balance and so on, and it supports shooting negatives and pictures with other special effects. It even supports GPS tags.

At the bottom of camera screen is camera’s menu bar . It bears a few icons that tweak the camera. Tap  icon to access camera settings.

The table below details this menu bar:

Icon	Description
	Closes camera.
	Opens camera settings: <ul style="list-style-type: none">  Sets where to store the picture to take. Options are: <ul style="list-style-type: none"> ▶  : the mobile computer’s internal storage (at My Device\My Documents\My Pictures by default) ▶  : the external storage i.e. the SD card (at My Device\Storage Card\DCIM\100CIPHR by default).  Sets image size (pixels) for the picture to take. Options are: <ul style="list-style-type: none"> ▶ 320 x 240 ▶ 640 x 480 ▶ 1280 x 960

	<ul style="list-style-type: none"> ▶ 1600 x 1200 ▶ 2048 x 1536 ▶ 2592 x 1944 <input checked="" type="checkbox"/> Sets quality for the picture to take. Options are: <ul style="list-style-type: none"> ▶ High ▶ Medium  Affixes date/time stamps to the picture to take. Date/time stamps are fixed at the upper-right of pictures.  Enables/disables previewing the picture to take, and sets how long to preview it. Options are: <ul style="list-style-type: none"> ▶ 3 sec ▶ 5 sec ▶ 10 sec  Enables/Disables GPS tag for a picture to take.  Enables/disables taking a picture some time after shutter button is pressed. Helpful for cases like self-portraits. Options are: <ul style="list-style-type: none"> ▶ 3 sec ▶ 5 sec ▶ 10 sec  Applies a special effect to the picture to take. Options are: <ul style="list-style-type: none"> ▶ Monochrome ▶ Sepia ▶ Negative  Sets White Balance for the picture to take. Options are: <ul style="list-style-type: none"> ▶ Auto: Leaves White Balance on automatic ▶  Fluorescent ▶  Tungsten ▶  Daylight ▶  Cloudy  Sets a scene mode for the picture to take. Options are: <ul style="list-style-type: none"> ▶  Outdoor ▶  Indoor lowlight  Adjusts brightness, contrast and sharpness for the pictures to take.
	<p>Sets if camera discharges a flash of light for the picture to take. Options are:</p> <ul style="list-style-type: none"> ▶ Auto: The default, which leaves the flash up to camera's decision according to its light meter. ▶ On: The flash is on for all shots. ▶ Off: The flash is off for all shots.
	<p>Opens Pictures & Videos folder where pictures and videos can be viewed, edited and output.</p>
	<p>Switches camera to camcorder.</p>

LAUNCH CAMCORDER

- 1) Launch camera as described in [Launch Camera](#).

Normally camera opens in landscape mode and readies to take pictures rather than shooting video so when it opens you have an  icon on menu bar.

- 2) Tap  icon to switch the application to camcorder.

If menu bar shows an  icon, the application is camcorder already and you can skip this step.

Camcorder launches.

CAMCORDER SCREEN

Camcorder launches showing subject area onscreen with a few status info at the upper-left and date/time info at the upper-right.

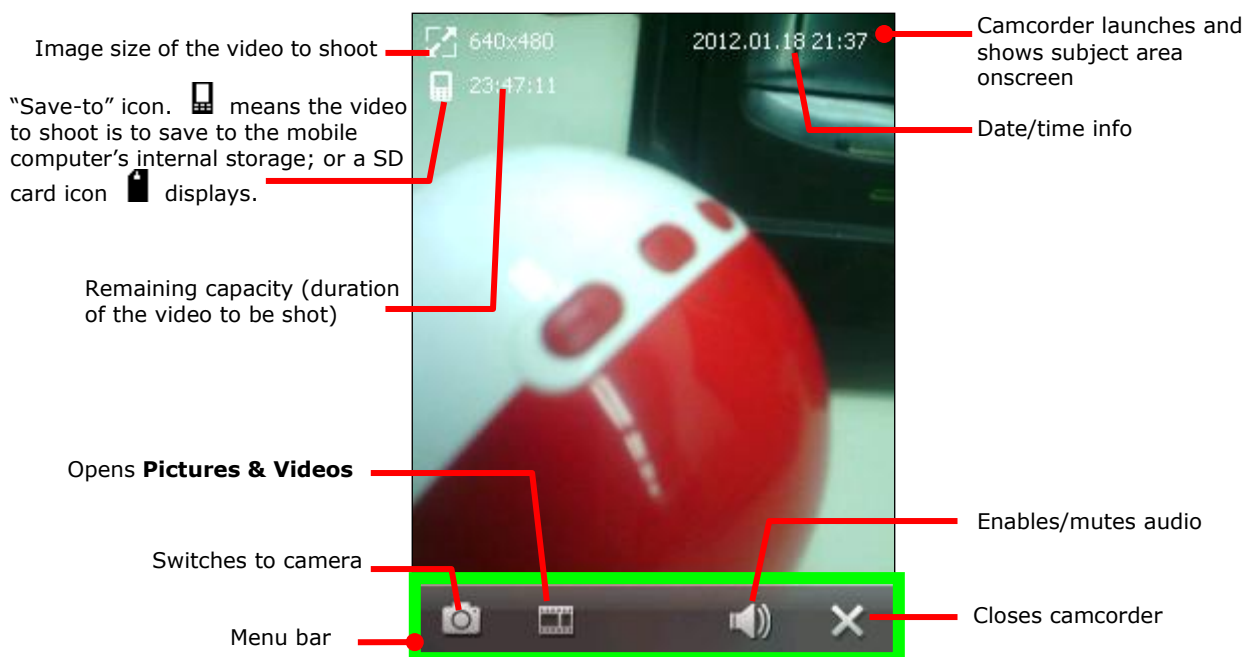

SHOOT VIDEOS

By default, videos are shot in WMV format and saves to the mobile computer's internal storage at **My Device\My Documents\My Pictures**. To change the default, see [Camera Settings](#).

To shoot a video:

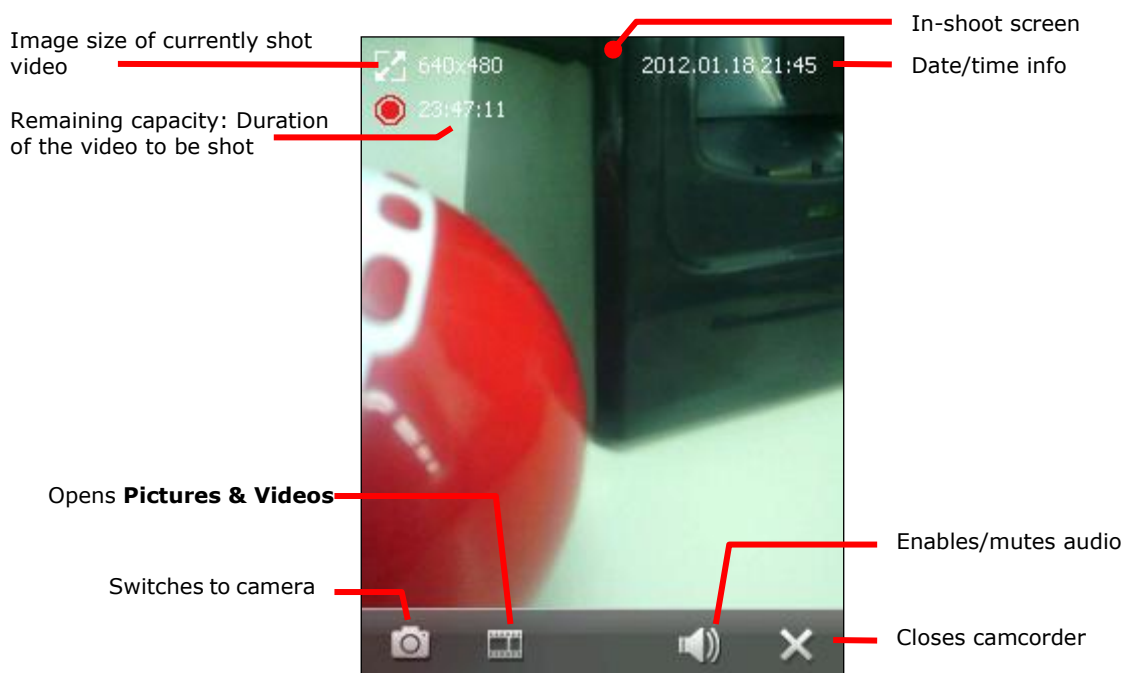

- 1) Launch camcorder as described in [Launch Camcorder](#).
Camcorder launches and shows subject area onscreen.
- 2) Point the lens and frame the scene where you want to start.
- 3) Hit physical shutter button. (See also [Overview](#).)

Camcorder starts to shoot the video. It displays a screen such as below:



- 4) Hit physical shutter button again to stop shooting.

A rotating  icon shows onscreen indicating the application is working on the video.

If preview is enabled, once the video is worked out, a preview screen shows the very first image of the video for a moment. Tap  to email the video by the mobile computer's data connections or tap  to discard it.

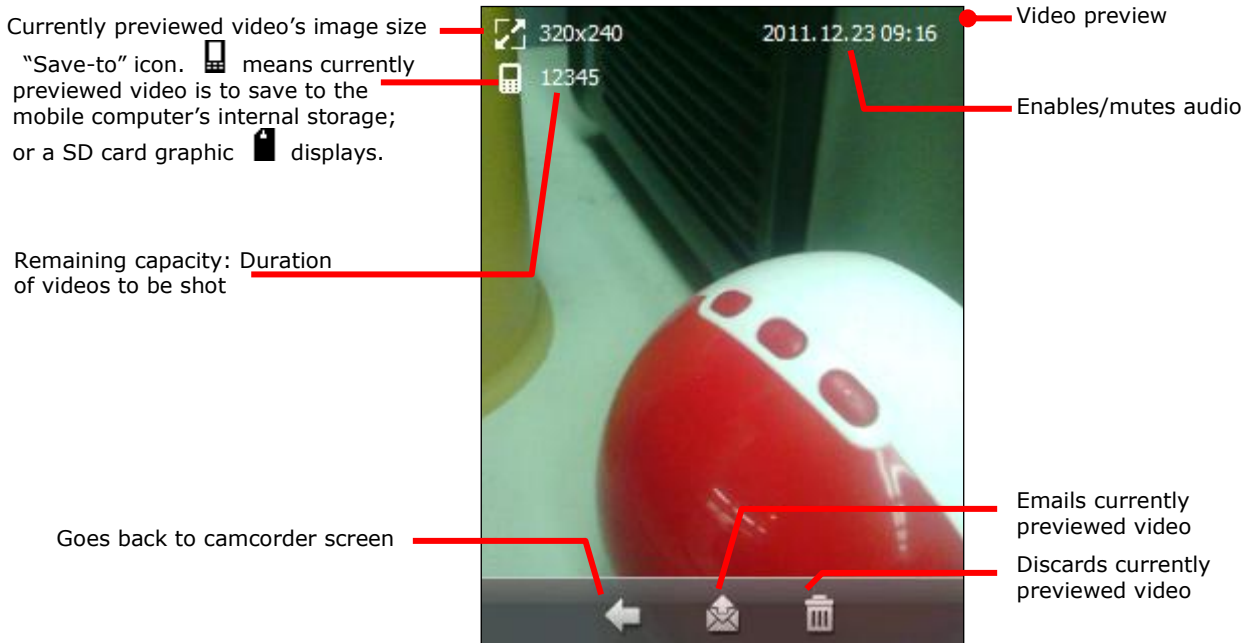





CAMCORDER SETTINGS





Camcorder shoots negative videos and videos with other special effects. Audio is also supported.

Launch camcorder as described in [Launch Camcorder](#). Tweak camcorder by the menu bar it featured - .

Camcorder's menu bar:

Icon	Description
	Closes camcorder.
	Enables/mutes audio.
	Opens Pictures & Videos where pictures and videos can be viewed, edited and output.
	Switches to camera.

Camcorder is supported by some camera settings. These settings should be made on camera's menu bar.

Menu Icon	Description
	Sets where to store the video to shoot. Options are: <ul style="list-style-type: none">▶  : the mobile computer's internal storage (at My Device\My Documents\My Pictures by default)▶  : the external storage i.e. the SD card (at My Device\Storage Card\DCIM\100CIPHR by default).
	Enables/disables previewing the video to shoot, and sets how long to preview it. Options are: <ul style="list-style-type: none">▶ 3 sec▶ 5 sec▶ 10 sec
	Applies a special effect to the video to shoot. Options are: <ul style="list-style-type: none">▶ Monochrome▶ Sepia▶ Negative

PICTURES & VIDEOS

Pictures & Videos is an application that views and edits the pictures taken and videos shoot, or those copied or downloaded. It also sets background for [Today Screen](#) and [Start Screen](#), and sets avatars for your contacts. It also emails pictures and videos.

LAUNCH PICTURES & VIDEOS

To launch Pictures & Videos:

- 1) On Start screen, tap **Pictures & Videos** icon .

OR

Tap  icon on camera or camcorder menu bar if it is active at the moment.

Pictures & Videos opens unfolding **My Device\My Documents\My Pictures**, the default folder that stores the pictures and videos copied/downloaded from external resources or took/shot on the mobile computer. Each picture and video therein displays in thumbnail.

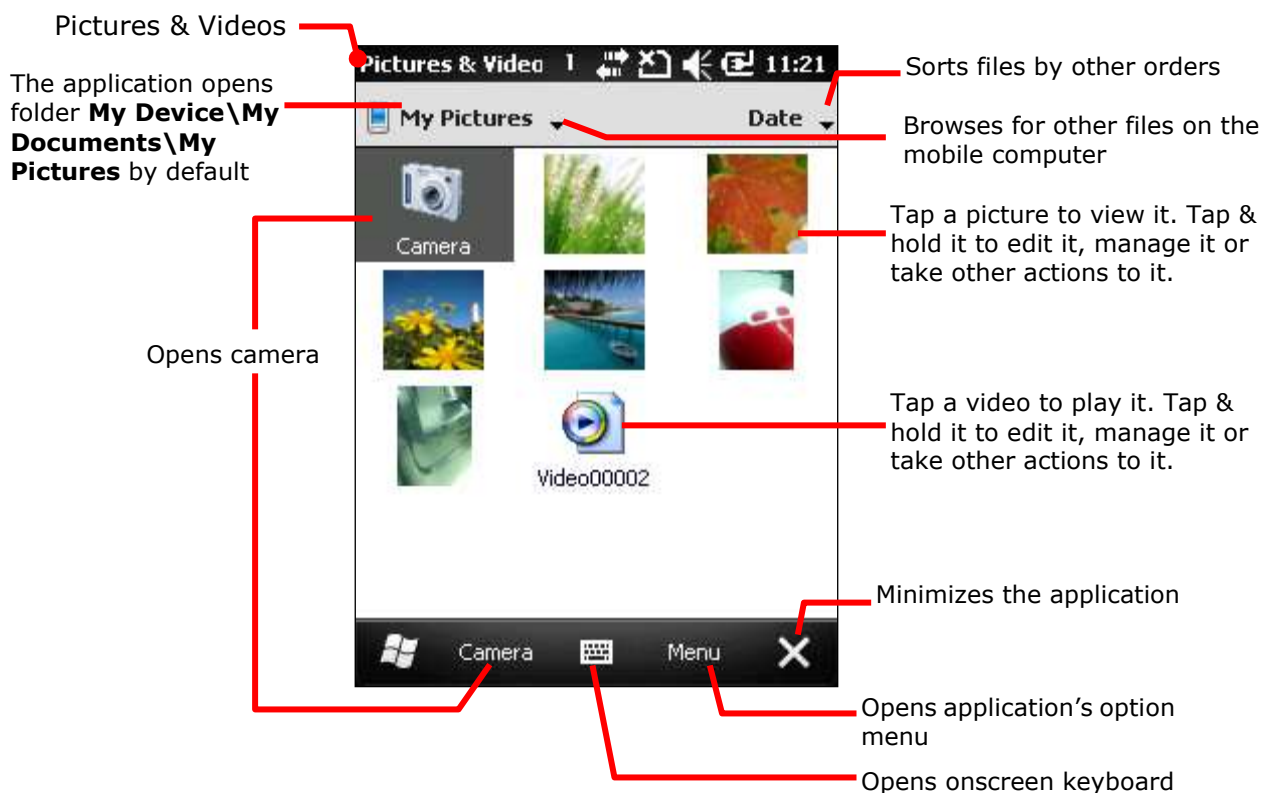

VIEW A PICTURE OR VIDEO

To view a picture or video:

- 1) Open Pictures & Video as described in [Launch Pictures & Videos](#).
Pictures & Videos opens.
- 2) Tap the thumbnail of the picture or video to view.

The picture displays or the video starts to play onscreen.

TAKE OTHER ACTIONS TO A VIDEO OR A PICTURE

To edit, manage or take other actions to a video or picture:

- 1) Open Pictures & Video as described in [Launch Pictures & Videos](#).
Pictures & Videos opens.
- 2) Tap & hold the thumbnail of the picture or video to edit, manage or take other actions to.
A context menu comes up.
- 3) Tap a menu item to perform the desired action.

OR

- 2) Tap the thumbnail of the prospective picture or video.
It becomes selected with highlight.
- 3) Tap the command button that comes up on [Softkey bar](#).

OPERATING SYSTEM

The mobile computer is powered by Windows Embedded Handheld 6.5, a member of Windows Embedded family branded for full compatibility with Windows Mobile 6.5.

Windows Embedded Handheld 6.5 features a prettier UI and a slew of fresh new looks unseen in the predecessor Windows CE. The most important enhancement of all is those touch-friendlier UI elements such as the inertial scrolling of lists and redesigned context menus. These elements are offered throughout the platform to save users from pulling out the stylus all the time and therefore particularly helpful for mobile computing. Users rely only on a few basic gestures such as Tap or Flick to navigate within the O.S.

Windows Embedded Handheld 6.5 also introduces a [Today Screen](#). The old drop-down “Start menu” is gone and replaced by a new [Start Screen](#) that lays out application icons in a staggered manner to maximize the space available to touch each icon and increase icons allowed onscreen.

This chapter goes through the basics of the O.S. and guides to [Today Screen](#) and [Start Screen](#) where all features on the mobile computer are accessible from.

IN THIS CHAPTER

1st Startup	88
Today Screen.....	89
Suspend & Reset Mobile Computer	102
Set Screen Lock	105
Work with Menus.....	106
Manage Applications	108

1ST STARTUP

Finished with the setup as described in [Main Battery Setup](#) and [Insert SD Card](#), proceed to power on the mobile computer as described in [Power On/Off](#).

If you haven't installed a SIM card, the mobile computer isn't able to connect to mobile networks for phone or data. However the computer is still able to connect to an available Wi-Fi hotspot for data. To learn more, see [Use Wi-Fi](#).

For 1st power-on, the O.S. boots into [Today Screen](#), a new feature introduced by Windows Embedded Handheld 6.5:



TODAY SCREEN

It is Today screen that shows when the mobile computer powers on or gets unlocked. Today screen shows a scrollable list of applications such as pictures, music, phone, voicemail, clock & time and so on, and the application in the center is always the active one.

When an application is active, it displays additional information, and command button(s) come(s) up on [Softkey bar](#) to cause the application to take action(s). Tap an active application to open it.

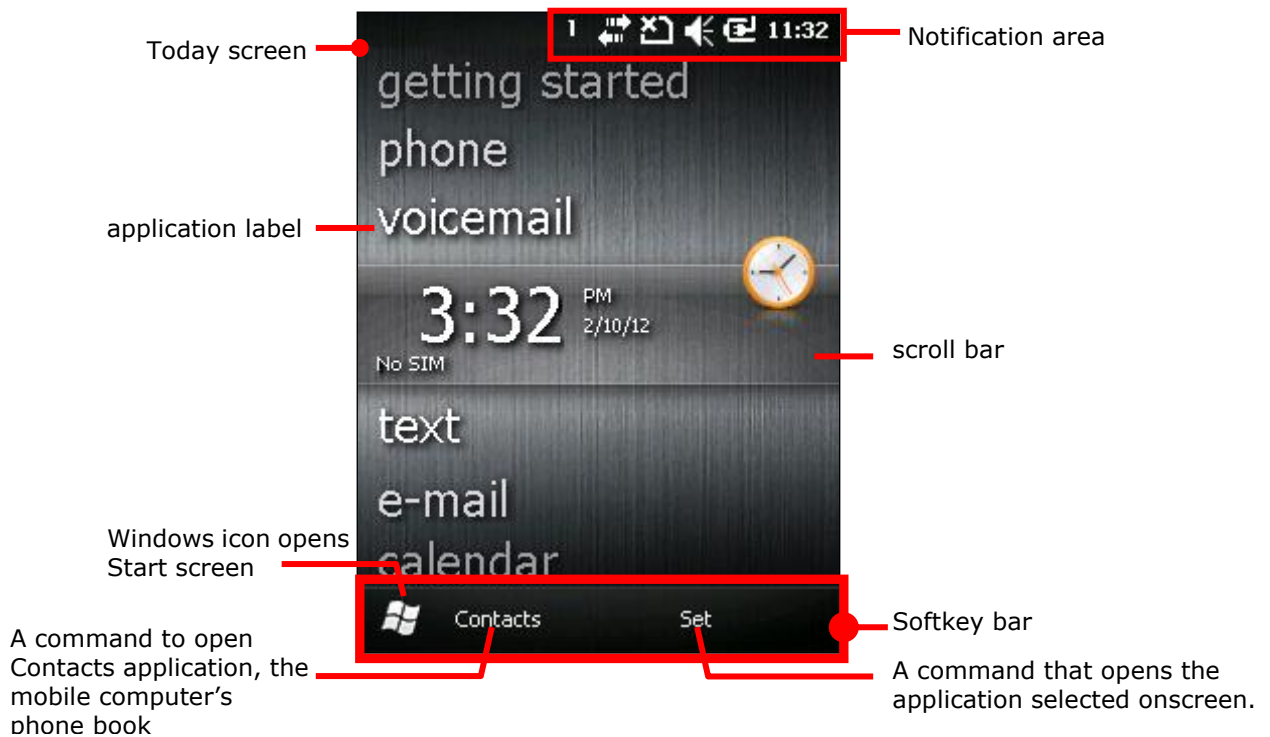

Facility	Description
notification area	<ul style="list-style-type: none"> ▶ Shows the mobile computer's statuses such as time, radio signal strength, battery level and so on. ▶ Displays the notifications issued by O.S.
scroll bar	Scrolls up and down the screen to select among the applications.
application label	<ul style="list-style-type: none"> ▶ Delivers application name. ▶ Delivers application status when selected by scroll bar. ▶ Opens the application when selected (by scroll bar) and tapped.
Softkey bar	A horizontal rectangle bar presented at the bottom of almost every screen within the O.S. It bares the commands to cause the currently active application/screen to take actions.
command	Launch actions from the current screen or currently active application. Commands are available in context with the application selected onscreen.
Windows icon 	Opens Start screen.

The screenshot below shows the mobile computer has one missed call and 2 unread text messages.

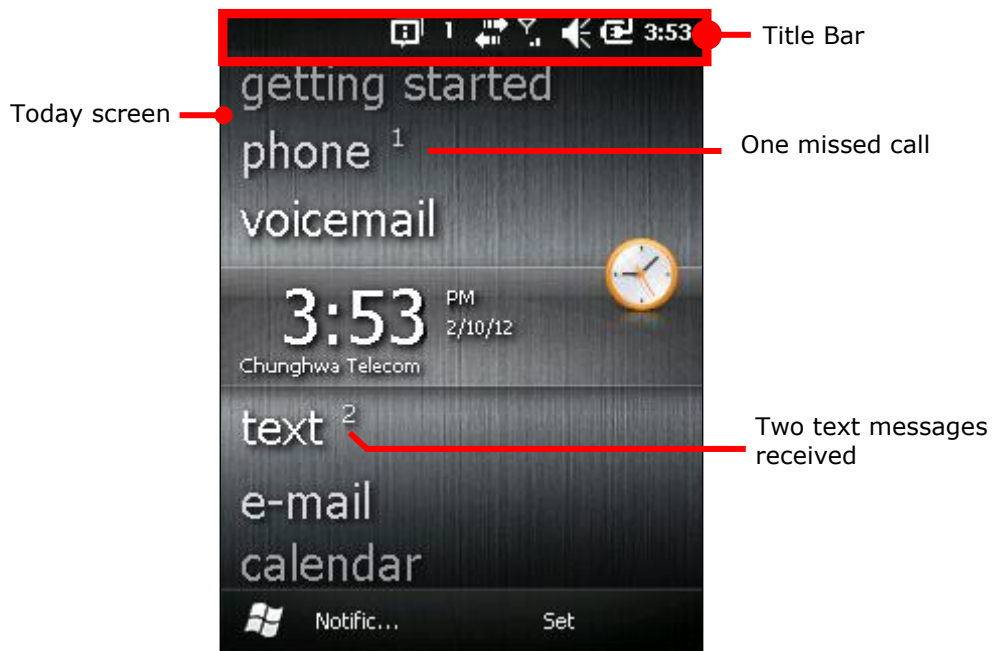



Take the action below to follow up:

- 1) Move the scroll bar to an application that needs management.
The application is selected.
- 2) Tap on it to open the application.

CUSTOMIZE TODAY SCREEN

Customize Today screen to change its appearance and presented items.

To customize Today screen:

- 1) Tap Windows icon  on [Softkey bar](#) or hit physical Windows key .
- 2) Tap **Settings | Home**.
Home settings open.
- 3) Select between **Appearance** and **Items** tabs.

Appearance tabbed page changes the background for Today screen while Items tabbed page changes the items to present.

Home Settings

- Appearance tabbed page

Changes the background for Today screen

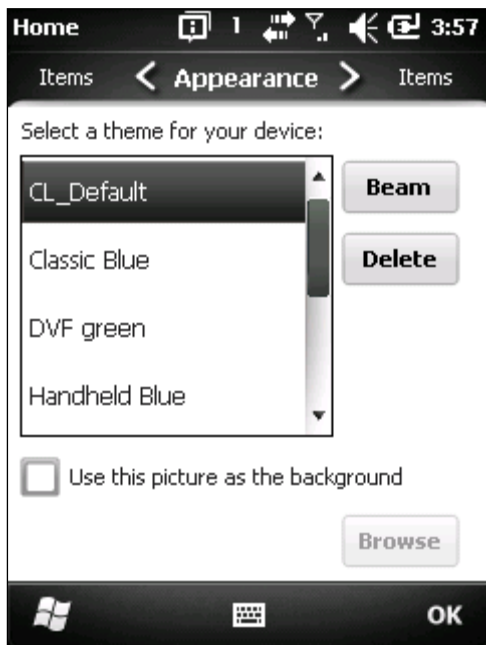



Home Settings

- Items tabbed page

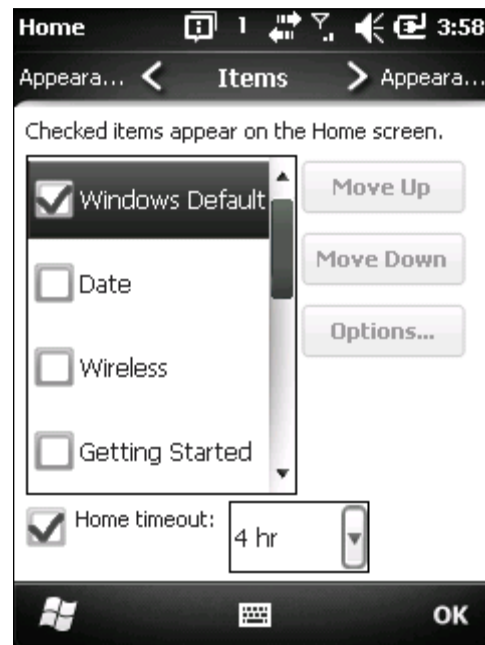
Changes the items to present on Today screen



RETURN TO TODAY SCREEN

Hit physical  key to return to Today screen. See also [Windows key](#) .

START SCREEN



Start screen is where all features on the mobile computer are accessed from. This screen lays out the application icons, shortcuts and so on in a staggered manner so each icon are more touchy and icons allowed onscreen are increased.

Basic operations on Start screen:



- ▶ If you see the icon of the application you want to open, tap it.
- ▶ Flick the screen to scroll down and bring more application icons into view. (See also [Use Touchscreen.](#))
- ▶ Customize Start screen by changing background and the items to display. See [Customize Start Screen](#) for more details.

Take a look around Start screen:



Facility	Description
Start screen	Accesses all applications and settings.
Notification area	Shows the time, radio signal strength, battery status, and other information. It also displays notification icons and status icons.
Minimize button 	Minimizes the active application or current screen.
Windows icon 	Opens Start screen. ▶ It opens Today screen when Start screen is opened.
lock icon 	Locks screen.

RETURN TO START SCREEN

Tap Windows icon  on [Softkey bar](#) or hit physical Windows key  to return to Start screen.

TITLE BAR

At the top of almost every screen is Title bar. It shows a title on the left and a notification area on the right. The title delivers the name of the current screen or currently active application while notification area shows a sequence of graphic icons delivering system statuses or notifications issued to users.

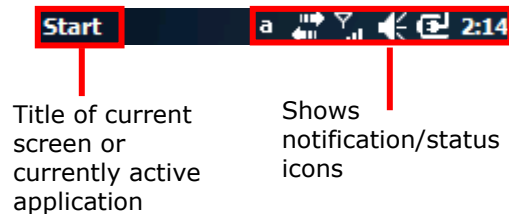







































Status icons assert mobile computer's contiguous statuses such as time, radio signal strength, battery level and so on. Notification icons report the arrival of a new message, alarm, and some ongoing events. When a notification is issued, an icon comes up in notification area, and the mobile computer produces a sound or vibrates as per "[Sounds & Notifications](#)" settings.

A general view of the status/notification icons on the mobile computer:

STATUS & NOTIFICATION ICONS

The O.S. presents the following icons for users. Note there may be application-particular icons not included here.

-  External power connected
-  Battery level (See [Monitor Battery Level](#) for details.)
-  Physical keypad enters alphabetic characters.
-  Physical keypad enters numbers & symbols.
-  System sound or phone ringer enabled
-  System sound or phone ringer muted
-  Vibration on
-  No SIM card installed
-  3G+ network available
-  3G+ network connected
-  3G network available
-  3G network connected

	HSDPA network available
	HSDPA connected
	EDGE network available
	EDGE connected
	GPRS network available
	GPRS connected
	Call in progress
	Call on hold
	Speakerphone on
	Missed call
	Phone off
	SIM card locked. PIN code required to turn on phone.
	Phone on with signal strength
	Mobile data (HSPA+/EDGE/GPRS) in use
	Wi-Fi on but not connected
	WiFi network(s) available
	WiFi in use
	Bluetooth in use
	Bluetooth headset in use
	Alarm on
	More notifications to be viewed. Tap Title bar or tap the "Notification" command on Softkey bar to view them all.
	Email received
	Text message received
	Syncing with a Windows-based PC
	Roaming
	Microsoft's appeal for customer feedback to help improve Windows Embedded Handheld software.

To learn more status icons of mobile/wireless data connections, see [Radios](#).

MANAGE NOTIFICATIONS



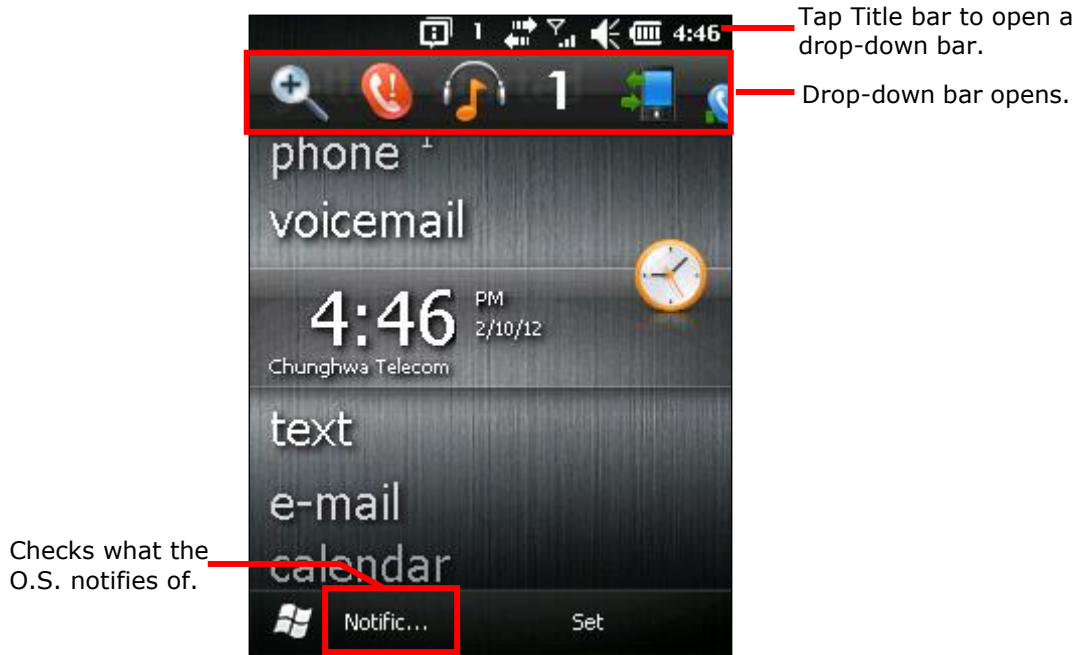



Since status/notification icons are relative small, tap Title bar to drop it down to have larger and touchy icons.



Note there are commands that come up on [Softkey bar](#) to manage a notification.

A general view of bigger notification/status icons on Drop-down bar:

Icon	Description
	Zooms in/out current screen.
	Leads to Wireless Manager and Connections (Manager) where your current mobile data can be viewed and configured.
	Leads to Wireless Manager and phone setting where phone status can be viewed and phone can be configured.
	This icon signifies Wi-Fi network(s) are available. Tap it to show available Wi-Fi hotspots and opens Wireless Manager to connect.
	Delivers current system/ringer volume and opens volume setting. See Onscreen Volume Gauge for more details.
	Opens power setting where battery level and charging status can be viewed. See More Charge Info .
	Opens Clock & Alarms setting.
	Reports customer feedback to Microsoft for improving Windows Embedded Handheld software.

	Opens the reminder for an alarm or appointment.
	Bluetooth A2DP profile in use. Tap it to access Bluetooth devices list.
	Checks a missed call.
	Checks a new e-mail.
	Opens Text application.
	Speakerphone on
	Roaming on

RESPOND TO NOTIFICATIONS

- 1) Tap Title bar to open Drop-down bar.
Drop-down bar opens.
- 2) Tap the status/notification icon to manage.
Drop-down bar closes and you are taken to the application in question.
For example, tapping a missed call's notification sends the screen to phone's call log where you can call back.

CLEAR NOTIFICATIONS

A notification won't be cleared until it is managed. Upon receiving a notification, tap Title bar to open Drop-down bar to manage it, or tap the action commands come up on [Softkey bar](#).

CUSTOMIZE START SCREEN

Customize Start screen by changing the background, application shortcuts, and so on. Rearrange the application shortcuts to make the applications that you use most often easiest to access.

CHANGE BACKGROUND

Craft your Start screen and Today screen with any of your own pictures or a number of designer's themes bundled with the O.S.

APPLY ONE OF YOUR OWN PICTURES:

- 1) On Start screen, tap **Pictures & Videos**.
Pictures & Videos opens.
- 2) Tap a picture. The picture opens. Tap the "Menu" command  on [Softkey bar](#).

OR

Tap & hold a picture.

Context menu shows up directly.

- 3) Tap **Set as Home background**.

The picture is set as background

APPLY ONE OF THE DESIGNER'S THEMES:

- 1) On Start screen, tab **Settings | Home**.

Appearance tabbed page opens.

- 2) Tap a theme from the list.

- 3) Tap the "OK" command on [Softkey bar](#).

Change is applied to Today & Start screens.

MOVE APPLICATION SHORTCUTS ON START SCREEN

On Start screen, you can re-tile the application shortcuts (icons) as you like. For example, move your favorite applications atop others:

- 1) Tap & hold an application icon until it gets hoisted by a white border.
- 2) Drag the application icon and do not release until it reaches the desired position.

ADD ITEMS TO START SCREEN

A variety of shortcuts can be added to Start screen to quick-open some files or bookmarked webpages or applications.

It relies on File Explorer , one of the O.S. featured applications, to add application shortcuts to Start screen:

ADD APPLICATION SHORTCUTS

- 1) On Start menu, tap File Explorer .

File Explorer opens.

- 2) Browse for the executable file of the application to add shortcut for.

- 3) Tap & hold the executable file.

A context menu comes up.

- 4) Tap **Copy**.

- 5) Browse for **My Device\Windows\Start Menu\Programs**.

Programs folder opens.

- 6) Tap & hold any vacancy onscreen.

Context menu comes up

- 7) Tap **Paste Shortcut**.

The application shortcut is added to Start screen.

ADD BOOKMARKED WEBPAGE SHORTCUTS

- 1) On Start screen, tap File Explorer .
File Explorer opens.
- 2) Browse for **My Device\Windows\Favorites**.
- 3) Tap & hold the bookmark to create shortcut for.
Context menu comes up.
- 4) Tap **Copy**.
- 5) Browse for **My Device\Windows\Start Menu\Programs**.
Programs folder opens.
- 6) Tap & hold any vacancy onscreen.
Context menu comes up
- 7) Tap **Paste Shortcut**.
Shortcut to the bookmarked page is added to Start screen.

ADD FILE SHORTCUTS

- 1) On Start screen, tap File Explorer .
File Explorer opens.
- 2) Browse for the file to create shortcut for.
- 3) Tap & hold it.
Context menu comes up.
- 4) Tap **Copy**
- 5) Browse for **My Device\Windows\Start Menu\Programs**.
Programs folder opens.
- 6) Tap & hold any vacancy onscreen.
Context menu comes up.
- 7) Tap **Paste Shortcut**.
Shortcut to the file is added to Start screen.

REMOVE ITEMS FROM START SCREEN













It relies on File Explorer  to remove an application shortcut from Start screen:















- 1) On Start screen, tap File Explorer .
File Explorer opens.
- 2) Browse for **My Device\Windows\StartMenu\Programs**.
Programs folder opens. This is where all application/bookmark/file shortcuts are.
- 3) Tap & hold the shortcut to remove.
Context menu comes up.
- 4) Tap **Delete**.



The shortcut to is removed from Start screen.

START SCREEN ICONS

Start screen presents a number of icons in a staggered pattern that makes them easier touchable. Each icon opens an application, folder or a group of settings when it is tapped. This section will give an overview of these icons.

Icon	Name	Description
	Home (Today)	Opens Today screen. See Today Screen .
	Phone	Launches the mobile computer's phone. See Place & End Calls for details.
	Text	Sends SMS text messages.
	E-mail	Pens and sends emails.
	Contacts	Tracks the contacts in your call logs, emails, instant messengers and so on. This application is sort of the mobile computer's phone book. See Call Contacts for details.
	Internet Explorer	Browses world wide web.
	Calendar	Creates and manages events, meetings, and appointments.
	Settings	Accesses system settings. See System Settings for details.
	Getting Started	Opens Getting Started application to set up some of O.S. basic features.
	Alarms	Opens Clock & Alarms application to: <ul style="list-style-type: none"> ▶ Set date, time, time zone for your locale. ▶ Set and manage alarms. See Clock & Alarms for details.
	Pictures & Videos	Views pictures and plays videos downloaded, copied or taken/shot with the built-in camera/camcorder. See Pictures & Videos .
	Internet Sharing	Shares the mobile computer's mobile data connection with another computer by a USB cable. See USB Internet Sharing & Bluetooth Internet Sharing for details.

	Search Phone	Searches contacts, files and others on the mobile computer.
	Office Mobile 2000	Opens Microsoft Office suite applications including Excel Mobile, SharePoint WorkSpace Mobile, OneNote Mobile, Word Mobile, and PowerPoint Mobile.
	Camera	Takes pictures and shoots videos. See Camera for details.
	Windows Media	Plays audio/video files.
	Marketplace	An online software download/purchase service which was shut down on 22 nd May 2012.
	MSN Weather	Checks the weather of your locale and other parts of the world.
	Windows Live	Accesses Windows Live services (such as Hotmail) or searches world wide web.
	MSN Money	Checks stocks.
	Calculator	Performs mathematical calculations.
	Notes	Creates notes that are typed, handwritten, drawn or having voice recordings.
	Tasks	Creates, tracks, and manages tasks.
	File Explorer	Browses and manages the files on local storage.
	ActiveSync	Synchronizes Microsoft Office Outlook data between the mobile computer and another Windows-based computer such as your PC. See Syncing Tool and subsequent sections for more details
	Task Manager	Monitors the active applications and CPU/memory usage on the mobile computer. See Task Manager .
	Help	Accesses O.S. online help.

	Remote Desktop Mobile	Connects to a remote computer.
	SimTkUI	Accesses the WAP/XML services provided by your mobile carrier.

SUSPEND & RESET MOBILE COMPUTER

To get rid of the annoying charging and replacing battery more often than you would like to, suspend the mobile computer when you are not actively using it. "Suspension" is a state to hold the device from running without turning off power. It is a "soft-off" state to enable less power consumption, and also a state from which a device can quickly awake from since there is no need to restart the software (applications).

SUSPEND MOBILE COMPUTER

The mobile computer is suspendible both manually and automatically. See also [Wake up Mobile Computer](#).

MANUAL SUSPENSION

Press physical Power button without holding it to suspend the mobile computer.

AUTO-SUSPENSION

Set up a power plan to suspend the mobile computer in an apt timing.

To set up a power plan:

- 1) On Start screen, tap **Settings | Systems | Power** .

Power setting opens showing Battery tabbed page.

- 2) Tap **Advanced** tab.

Advanced tabbed page opens.

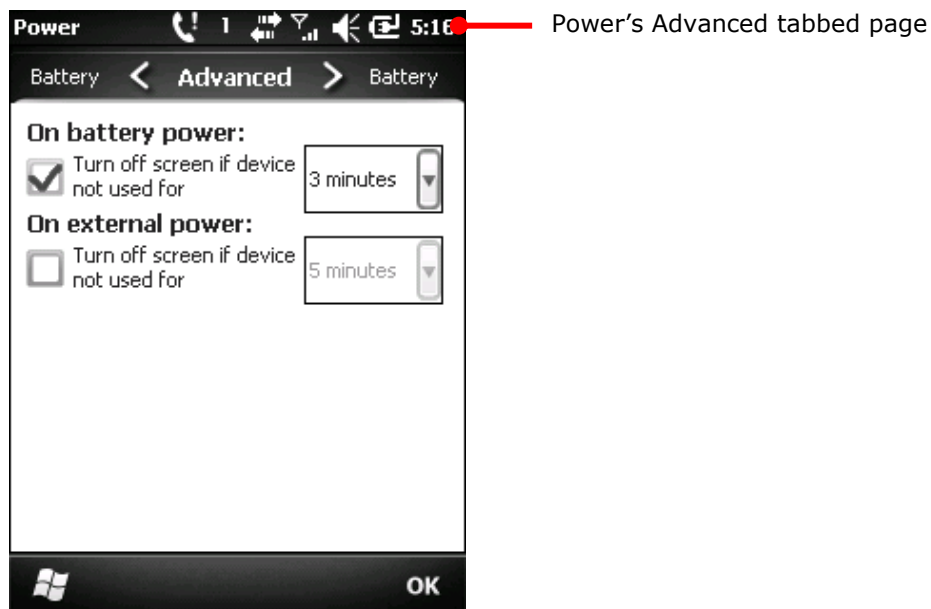

- 3) Set a time to turn off LCD and suspend the mobile computer.

Note the following cases also suspend the mobile computer:

- ▶ Battery door isn't in place.
- ▶ Main battery level drops under 7%.
- ▶ Battery fails.

To get the most from the battery power, see [Optimize Battery Life](#).

WAKE UP MOBILE COMPUTER

"Waking up" is to restore the suspended device to its previous working state. The mobile computer is awakenable both manually and automatically.

MANUAL AWAKENING

Press (without holding) the physical Power button or central scan key to wake up the mobile computer.

AUTO-AWAKING

The mobile computer wakes up by itself when either of the following happens:

- ▶ Plugging of USB cable.
- ▶ WWAN ringing signal gets active.

RESET MOBILE COMPUTER

The mobile computer features 2 reset mechanisms, warm boot and cold boot. These boots troubleshoot some problems in the O.S. and applications. Make use of the physical Power button and the reset toggle recessed in a cutout on the mobile computer's front bezel to generate said boots.

[1] Power button

[2] Reset toggle

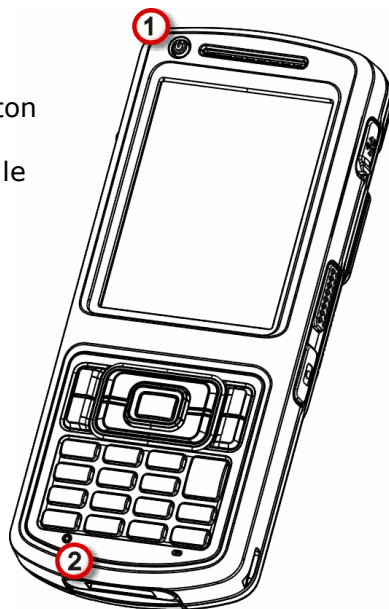

Figure 18: Reset

WARM BOOT (SOFT RESET)

“Warm boot” is also known as “soft reset”. When the mobile computer runs slower than normal or when one or more active applications crash, perform warm boot to close all active applications and restart the mobile computer without turning off power supply to hardware.

After warm boot, all flash memory and clock/calendar time are kept, and all saved data are preserved. However the unsaved data is gone after warm boot if the warm boot is performed when the application in question is still running.

To perform “warm boot”:

- ▶ Hit the reset toggle using the stylus.

COLD BOOT (HARD RESET)

“Cold boot” is also known as “hard reset”. In case one or more applications are misbehaving and the mobile computer just doesn’t cooperate, perform cold boot as the final act.

“Cold boot” restarts the mobile computer by turning power off and on just like pulling the battery. As “Cold boot” initializes DRAM, all data cached in DRAM is gone after cold boot. However all flash memory and clock/calendar time are preserved.

To perform “cold boot”:

- ▶ Press and hold the physical Power button while in the same time poke the reset toggle for just a fraction of second.

Note Power button should be held down and not released until the mobile computer vibrates and powers on.

OR

- ▶ Simply reload main battery and re-power on the mobile computer.

SET SCREEN LOCK

Out of security concern, you may want to restrict the access to the mobile computer by a unique lock you create. The O.S. supports setting up a password to recover the access to the mobile computer.

To set up a unlock password:

- 1) On Start screen, tap **Settings | Lock**.
Password setting opens.
- 2) Configure how much time is the mobile computer unused for to lock out the screen. And set up a unique password that unlocks screen.
- 3) Tap the "OK" command on Softkey bar to apply the change and quit setting.

UNLOCK SCREEN

Once a screen lock is set, the screen locks out all access after the mobile computer idles for the defined time. To recover access to the mobile computer:

- 1) On the locked screen, tap and drag the lock icon  to the right or left.
An onscreen keypad appears resembling an average phone keypad.
- 2) Enter either the password that unlocks the screen or an emergency call number.



Enter the password that unlocks screen.



If an emergency call number is entered, the buttons to place and end calls display.

- 3) Follow onscreen instruction to proceed.

WORK WITH MENUS

The O.S. presents two kinds of menus: option menus and context menus. By these menus, users are able to operate onscreen and use applications.

OPTION MENU

Normally a screen or an active application features a "Menu" command  on [Softkey bar](#) to launch an "option menu", which causes actions to be taken by the screen or the active application. Examples:



Internet Explorer features a menu bar along the bottom that includes a "Menu" command to open a option menu.

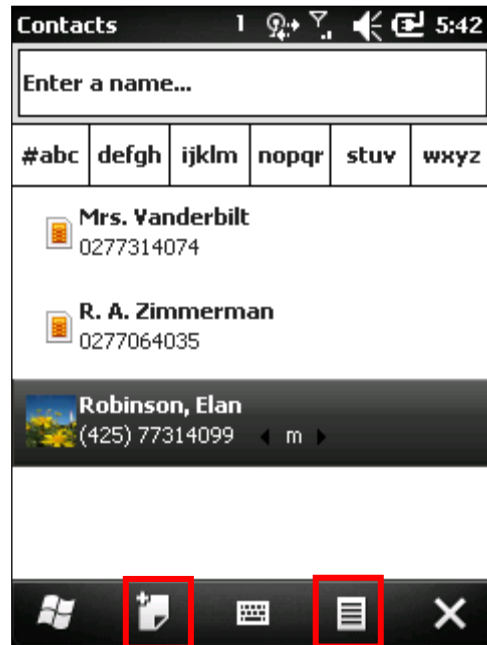

Contacts application features two commands on [Softkey bar](#). Tap a command to cause actions taken by the application.

Note some screens/applications may not have an option menu.



A screen that doesn't feature a "Menu" command on [Softkey bar](#).

An example of Start screen.

CONTEXT MENUS

The context menu on the other hand contains the actions to be taken to a specific item selected onscreen. Tap & hold an onscreen item to open the context menu.

Note not all items have context menus. Nothing happens if you touch and hold one of this kind.

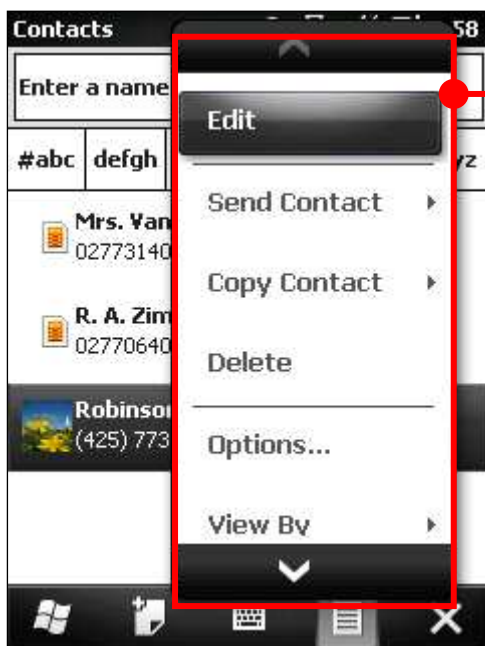

A context menu launches for a selected item.

An example of Contacts application.

MANAGE APPLICATIONS

On Windows Embedded Handheld 6.5, Start screen is where all the O.S.' inherent applications are accessed from.

In the O.S., when you run an application, the other applications that have been running don't stop but keep on running whether it is music that is played or the webpage that is being browsed.

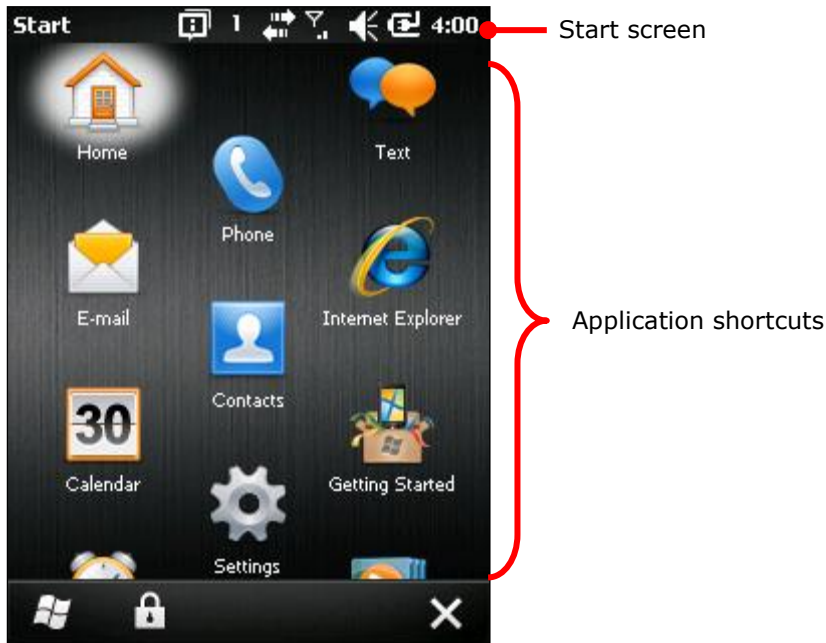

TASK MANAGER

The O.S. featured Task Manager  is a tool to monitor the memory and CPU resources consumed by each running application and cached process. Task Manager also closes applications and switches between the opened applications.

LAUNCH TASK MANAGER

To launch Task Manager:

- 1) On Start screen, tap Task Manager icon .
Task Manager opens monitoring opened applications.

MONITOR OPENED APPLICATIONS

Task Manager launches monitoring opened applications:

Task Manager screen

Label of "Application" says opened applications are being monitored now.

Delivers the application's memory usage. Tap to ascend/descend the entries.

Deliver the application's CPU usage. Tap to ascend/descend the entries.

Closes the selected application onscreen.

Opens Task Manager's option menu.

Application	Mem	CPU
ActiveSync	852K	0 %
Notes	232K	0 %
Search	228K	0 %
Reader Config	216K	0 %
Task Manager	160K	0 %
BackupUtility	120K	0 %
File Explorer	116K	0 %

To monitor cached processes, see [Monitor Cached Processes](#).

CLOSE APPLICATIONS

Close an application when it isn't used, or when it is misbehaving. Check for any misbehaving application by looking up its usage of memory and CPU.

In the O.S., it depends to close an application. Some applications have their facilities to close themselves such as a GUI button or a menu command while others don't. When it is the latter case, Task Manager closes them for you.

To close an application by Task Manager:

- 1) Launching Task Manager as described in [Launch Task Manager](#).

Task Manager opens monitoring opened applications.

- 2) Tap & hold the application to close. From the context menu that comes up, tap **End Task**.

OR

Tap the application to close. (Then the application is selected by highlight onscreen.) Then tap the "End Task" command on [Softkey bar](#).

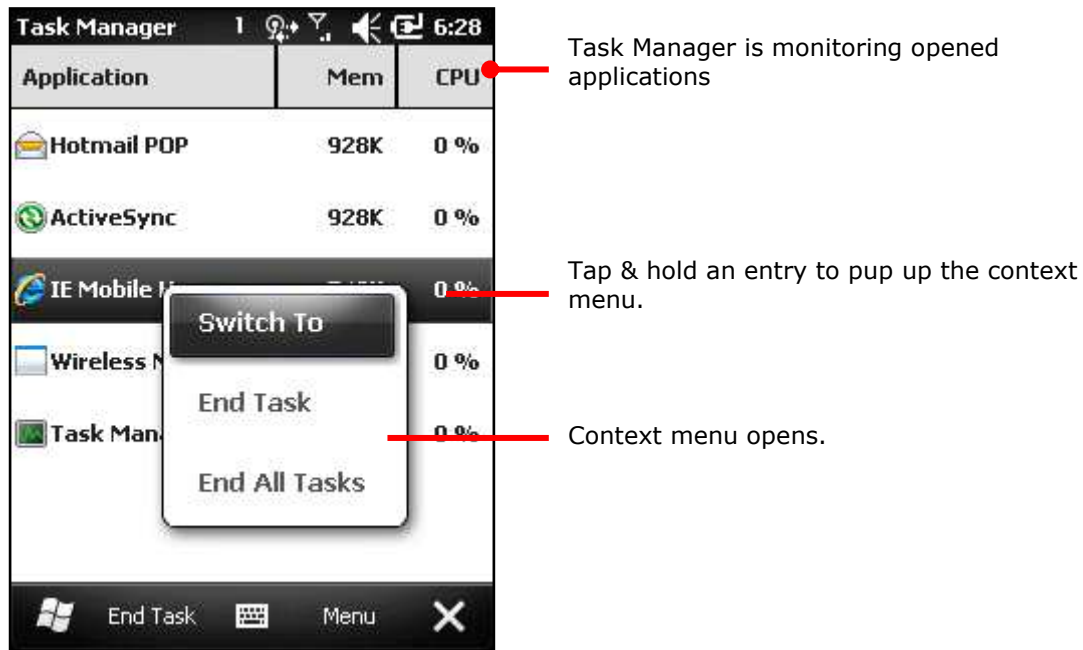

SWITCH TO ANOTHER OPENED APPLICATION

To switch to another opened application:

- 1) Launching Task Manager as described in [Launch Task Manager](#).
Task Manager opens monitoring opened applications.
- 2) Tap & hold the application to switch to.
Context menu shows up.
- 3) Tap **Switch to**.
The application to switch to opens onscreen.

MONITOR CACHED PROCESSES

Task Manager  also monitors how much RAM and CPU is being consumed by a cached processes.

To monitor cached processes:

- 1) Launching Task Manager as described in [Launch Task Manager](#).
Task Manager opens monitoring opened applications.
- 2) Tap the "Menu" command  on [Softkey bar](#).
Option menu opens.
- 3) Tap **View | Processes**.

Task Manager shifts to monitor processes.

Task Manager
monitors cached
processes.

Process	Mem	CPU
filesys.exe	11.7M	0 %
device.exe	5.73M	1 %
gwes.exe	2.32M	0 %
shell32.exe	1.82M	0 %
services.exe	1.82M	0 %
repllog.exe	852K	0 %
csrss.exe	676K	0 %

Note: Stopping an application or operating system processes or services may interrupt one or more dependant functions on the mobile computer. You may need to restart the mobile computer to recover full functionality.

DOWNLOAD & INSTALL APPLICATIONS

A rich resource of applications is downloadable from the Internet to run on the O.S. The executable files to install application in Windows Embedded Handheld 6.5 are named with the suffix of ".cab", short for "cabinet". Download a ".cab" files that supports Windows Embedded Handheld 6.5.

Warning: To protect your mobile computer and personal data, always download applications from trusted sources.

As mentioned in [Add/Remove Programs](#), you can download and install an application on your PC first and offload it to the mobile computer later using Microsoft's ActiveSync.

Well the O.S. allows you to download and install an application right from the mobile computer.

To download an application, the mobile computer needs to get online first. See [Radios](#) or [USB Pass-through Networking](#) or [Bluetooth Pass-through Networking](#) to get data connections for the mobile computer.

After download finishes, use File Explorer  to browse for the application program in the local storage. Tap the program file to run the installation.

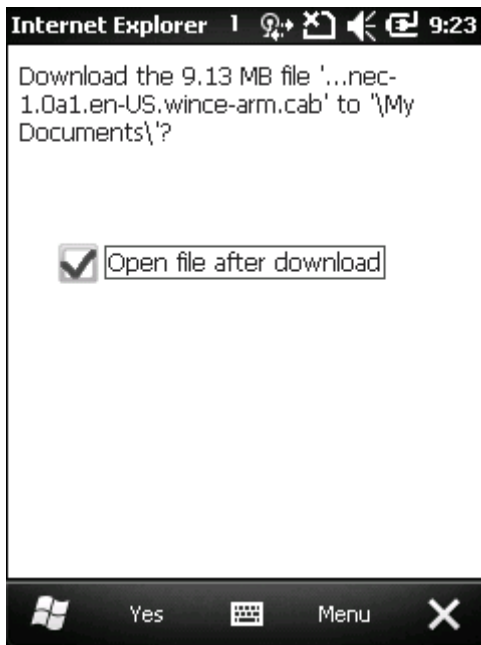

This screenshot shows downloading an application program on the mobile computer. When asked to confirm the download, tap the "Yes" command on [Softkey bar](#).

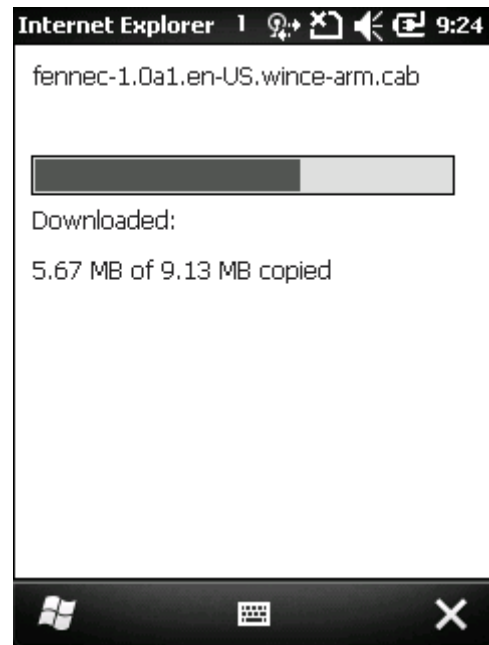

Download starts and proceeds.

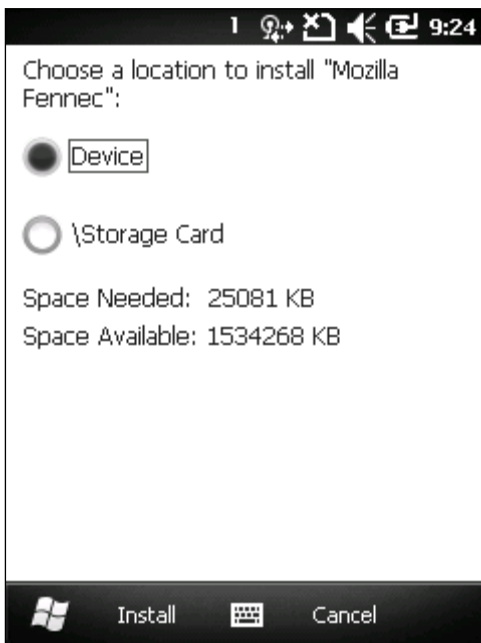

If an SD card is equipped, you're asked where to install the application; or this screen won't show and the application is straight installed to internal storage.

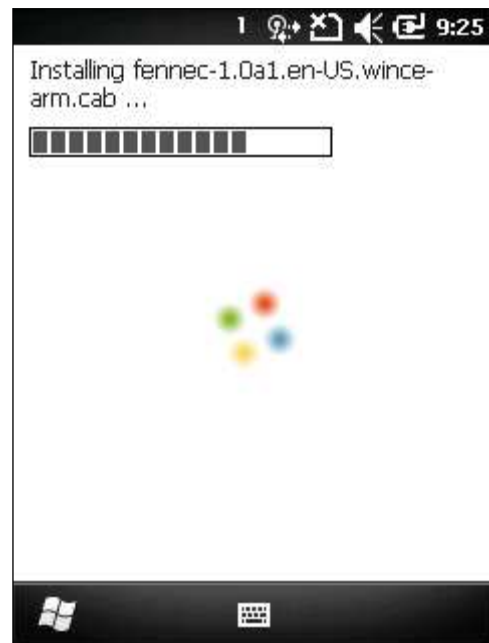

Installation progresses.

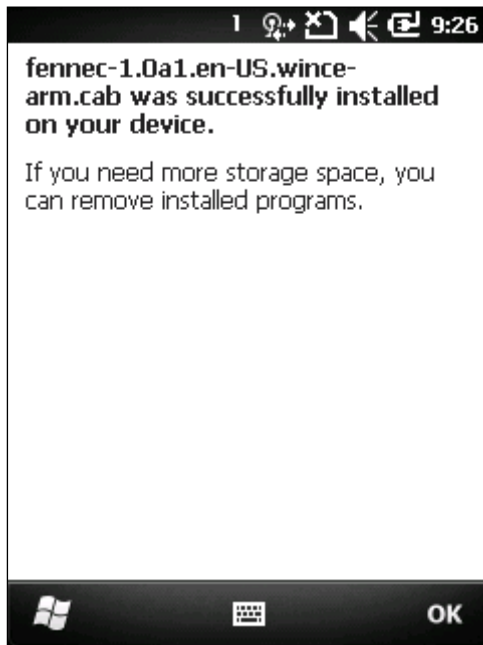

Installation completes. Tap "OK" command to finish and quit installation.

UNINSTALL APPLICATIONS

On the mobile computer, the acquired (non-inherent) applications are subject to your manual uninstallation. To uninstall an application:

- 1) On Start screen, tap **Settings | System | Remove Programs** .

Remove Programs opens showing the applications downloaded and installed from external sources.

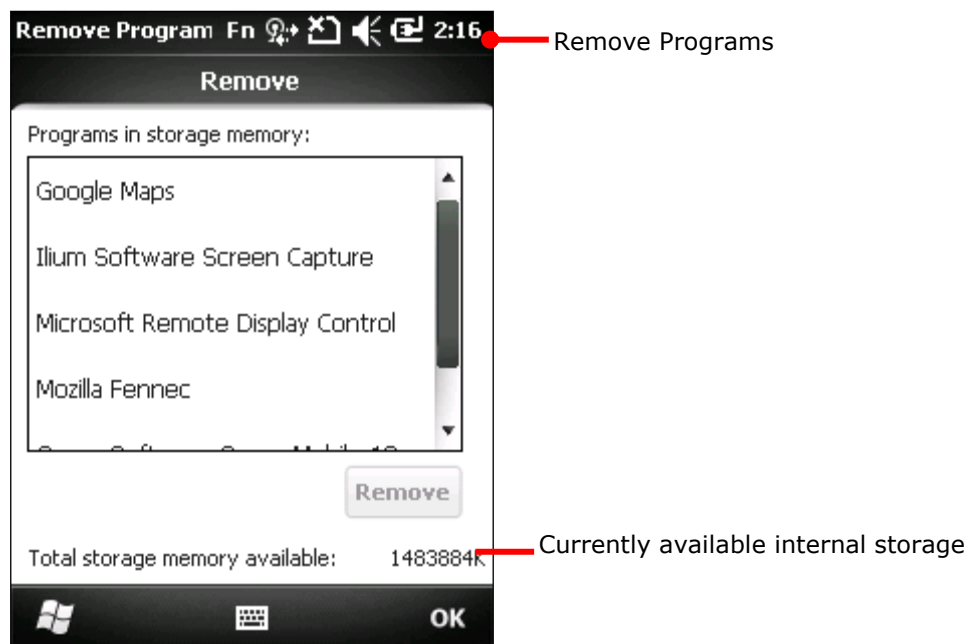

- 2) Tap the application to remove.
The lower-right "Remove" button becomes available.
- 3) Tap the "Remove" button to uninstall the application.
- 4) Follow onscreen instruction to complete through the uninstallation.

RADIOS

The mobile computer is a versatile networker. It integrates Wi-Fi and Bluetooth for wireless data, and optionally a 3.75G module for mobile data. It also includes an GPS receiver to calculate your locations on earth with street-level accuracy. By the radios, the mobile computer keeps the business online all the time.

In this chapter, you will learn how these radios can work for you.

IN THIS CHAPTER

Access Cellular WAN	116
Use Wi-Fi.....	121
Use Bluetooth	130
Connect to Virtual Private Networks	142
Install Secure Certificates	147
Location Discovery	149
Use Secure Access Module	158

ACCESS CELLULAR WAN













When you insert a SIM card and turn on the mobile computer, the mobile computer connects to your mobile carrier's cellular wide area networks for data.

Different locations may have different mobile networks available. The mobile computer auto-connects to the fastest mobile network available for data.

To access Internet, set the mobile computer to use either Wi-Fi or the SIM-enabled mobile data. See also [Use Wi-Fi](#).



STATUS ICONS

Title bar features the following icons to deliver the mobile (WWAN) network connected to, with signal strength.

Icon	Description
	3G+ network available
	3G+ network connected
	3G network available
	3G network connected
	HSDPA network available
	HSDPA connected
	EDGE network available
	EDGE connected
	GPRS network available
	GPRS connected
	HSDPA/EDGE/GPRS in use
	Data limited to 2G only

CHECK WHAT NETWORK YOU'RE USING

To check what network you're using now:

- 1) On Start screen, tap **Settings | Connections | Wireless Manager** .
Wireless Manager opens.
- 2) Tap the "Menu" command  on [Softkey bar](#).
Option menu shows.
- 3) Tap **Phone Settings**.
Phone settings open showing Sound tabbed page.

- 4) Tap continuously on the tabs to bring **Network** tab into view.
- 5) Tap **Network** tab.

Network tabbed page opens showing the network currently connected to at the top.

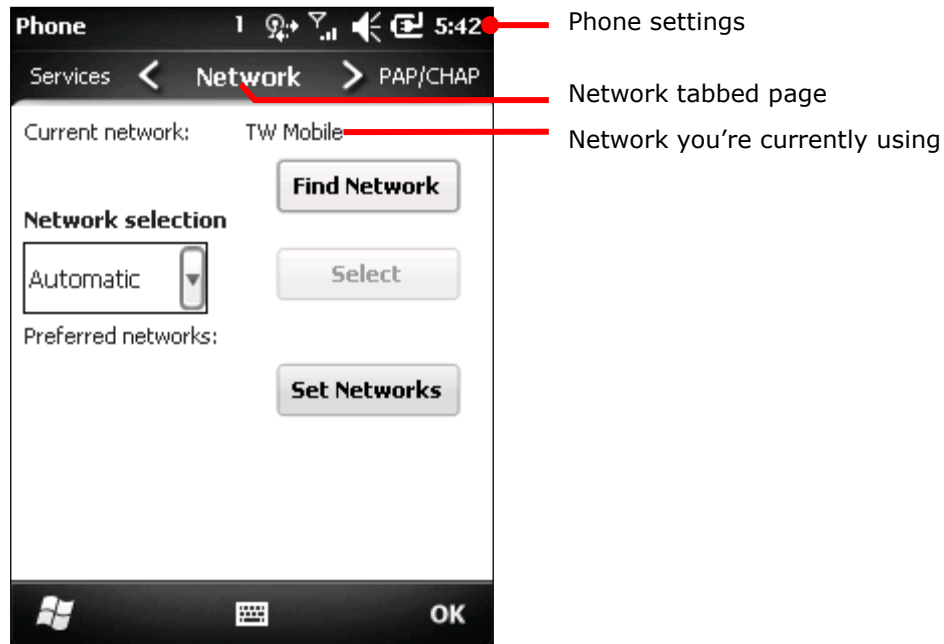

ENABLE/DISABLE MOBILE DATA

To turn on/off the mobile computer's mobile data (HSPA+):

- 1) On Start screen, tap **Settings** | **Connections** | **Wireless Manager** . Wireless Manager opens.
- 2) Tap the "Menu" command on [Softkey bar](#). Option menu opens.
- 3) Tap **Disconnect Cellular Data**. Mobile data is disabled.

USE ONLY 2G NETWORKS

Limit mobile data to 2G networks (GPRS or EDGE) to extend battery life or when you are not intensively transmitting data.

To limit mobile data to only 2G:

- 1) On Start screen, tap **Settings** | **Connections** | **Wireless Manager** . Wireless Manager opens.
- 2) Tap the "Menu" command  on [Softkey bar](#). Option menu opens.

- 3) Tap Phone Settings.
Phone settings open.
- 4) Tap continuously on the tabs to bring **GSM/UMTS** tab into view.
- 5) Tap **GSM/UMTS** tab.
GSM/UMTS tabbed page opens.
- 6) Tap **GSM (2G Only)** from the drop-downs.
- 7) Tap **Apply** to apply the change.
- 8) Tap the "OK" command on [Softkey bar](#) to quit setting.

CELLULAR DATA SETUP

To set up mobile data (GPRS/EDGE/UMTS/HSPA):

- 1) On Start screen, tap **Settings | Connections | Connections (Manager)** .
Connections setting opens showing Tasks tabbed page.
- 2) Tap **Add a new modem connection** under **My ISP**.
Make New Connection page opens.
- 3) Name the connection.
- 4) From **Select a modem** drop-downs, tap **Cellular Line (GPRS)**.

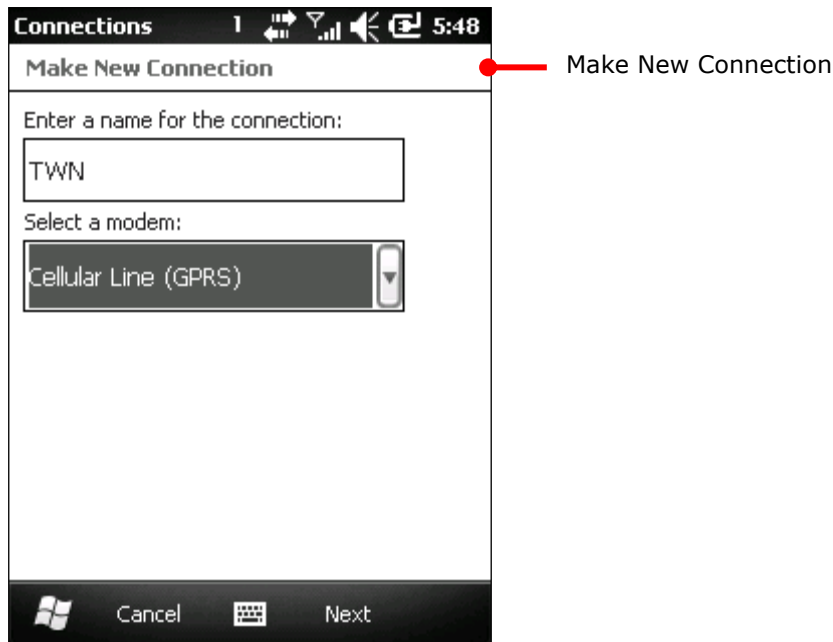

- 5) Tap **Next** to proceed.
- 6) Enter the Access Point Name (APN) of the connection. Consult your mobile carrier for such APN.
- 7) Enter the username, password, and domain if your connection needs them. And tap the **Advanced...** button if your connection needs TCP/IP and specific server address.
- 8) Tap the "Finish" command on [Softkey bar](#) to apply the change and settings.

The mobile computer tries to connect to your mobile service. Once connected, it can be checked up as described in [Check What Network You're Using](#).

Note to turn off Wi-Fi to access mobile data because Wi-Fi supersedes mobile data.

EDIT & ADD ACCESS POINTS

When it is agreed between you and your mobile carrier that the current Access Point Name (APN) should be changed or a new access point needs to be created, consult your mobile carrier for the APN and detailed settings.

To edit an existing APN:

- 1) On Start screen, tap **Settings | Connections | Connections (Manager)**  .
Connections setting opens showing Task tabbed page.
- 2) Under **My ISP** label, tap **Manage existing connections** link.
- 3) My ISP opens showing Modem tabbed page.

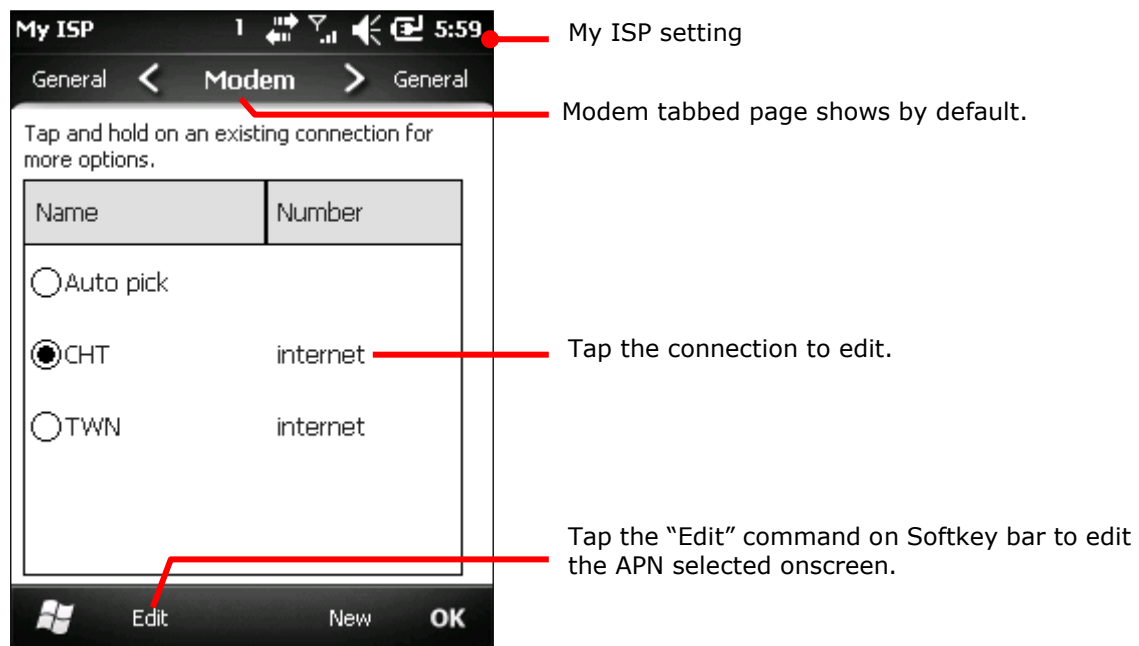

- 4) Tap the APN to edit.
The APN to edit is selected onscreen, and the "Edit" command becomes available on [Softkey bar](#).
- 5) Tap the "Edit" command on [Softkey bar](#).
- 6) Follow onscreen instruction to finish editing.

USB INTERNET SHARING

“Internet Sharing” or “Internet Tethering” enables your Windows-based PC to connect to Internet using the mobile computer's mobile data (or dial-up data). The mobile computer functions as a Wi-Fi “hotspot” (a.k.a “access point”) that your PC connects to.

By “Internet Sharing” , the mobile computer uses USB or Bluetooth to tether your PC to Internet. For Bluetooth-based internet tethering, see [Bluetooth Internet Sharing](#).

To USB-tether your PC to Internet:

- 1) Connect the mobile computer and your PC with a USB cable that came with your purchase as described in [Direct Data Connection](#).
- 2) On the mobile computer, tap **Internet Sharing**  from Start screen.

Internet Sharing opens.

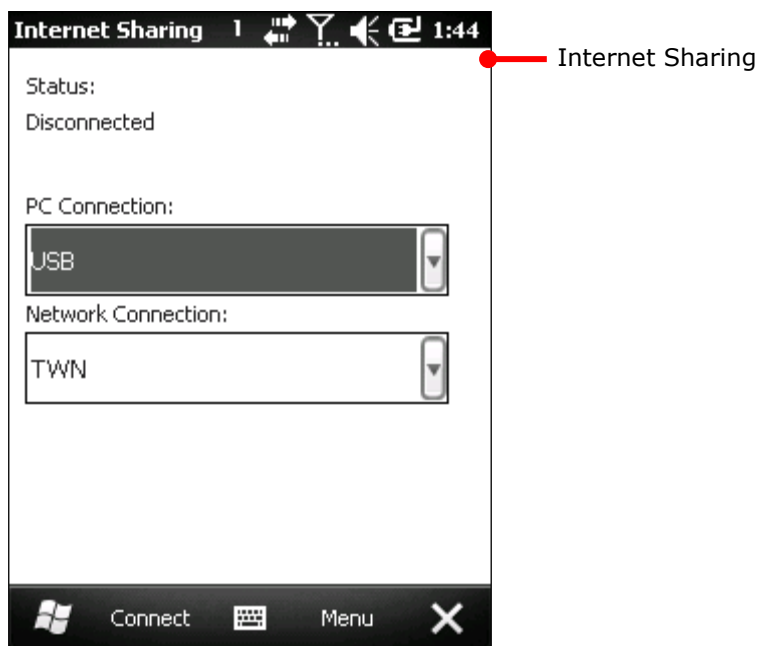

- 3) Select **USB** for **PC Connection**, and select your mobile service for **Network Connection**.
- 4) Tap the “Connect” command on Softkey bar to start Internet tethering.

The mobile computer prompts “Connected” in a few seconds when the PC connects to Internet.

Tap the “**Discon...**” command on the mobile computer to disconnect.

In case of problems, open Start screen | **Settings** | **Connections** | **USB to PC**, and make sure **Enable advanced network functionality** is selected.

USE WI-FI

The mobile computer is capable of Wi-Fi, a wireless networking technology making use of an access point, also known as “hotspot”, to connect to a wireless local area network.



To use Wi-Fi, the mobile computer has to connect to a hotspot. Some hotspots are open to connect while others request for a key to authenticate access. Authentication key must be included in the mobile computer’s Wi-Fi settings.

For the authentications based on secure certificates, see [Install Secure Certificates](#).

Turn off Wi-Fi when it isn’t used to extend battery life. See [Enable/Disable Wi-Fi](#).

STATUS ICONS

Wi-Fi status icons:

Status Icon	Description
	Wi-Fi on but not connected
	WiFi network(s) available
	WiFi in use



ENABLE/DISABLE WI-FI

To enable/disable Wi-Fi data on the mobile computer:

- 1) On Start screen, tap **Settings** | **Connections** | **Wireless Manager** .

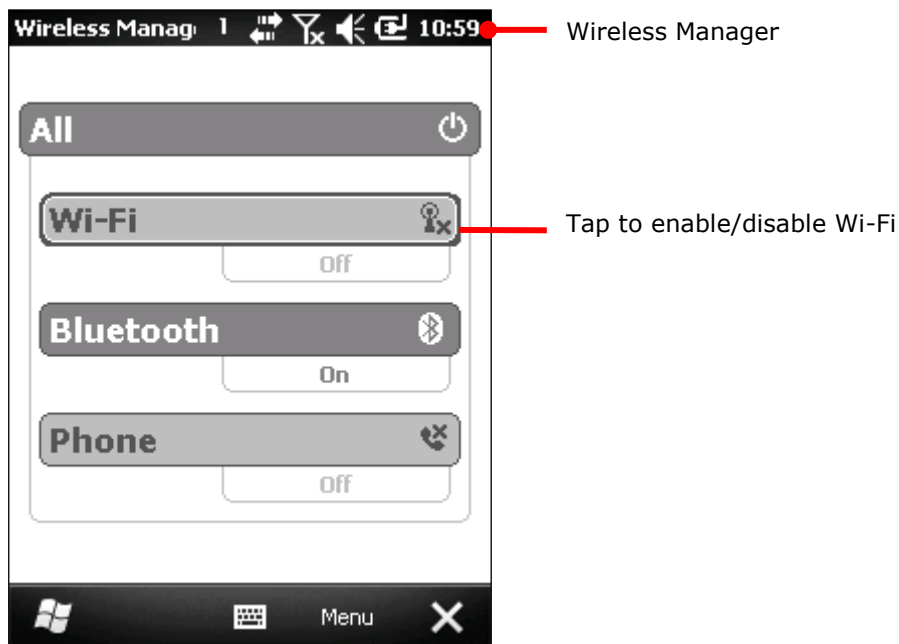
Wireless Manager opens.





The Wi-Fi entry shows an  if Wi-Fi is off at the moment; otherwise it shows an  icon suggesting Wi-Fi is on.

- 2) Tap the "Wi-Fi" entry.

Wi-Fi is on or off.

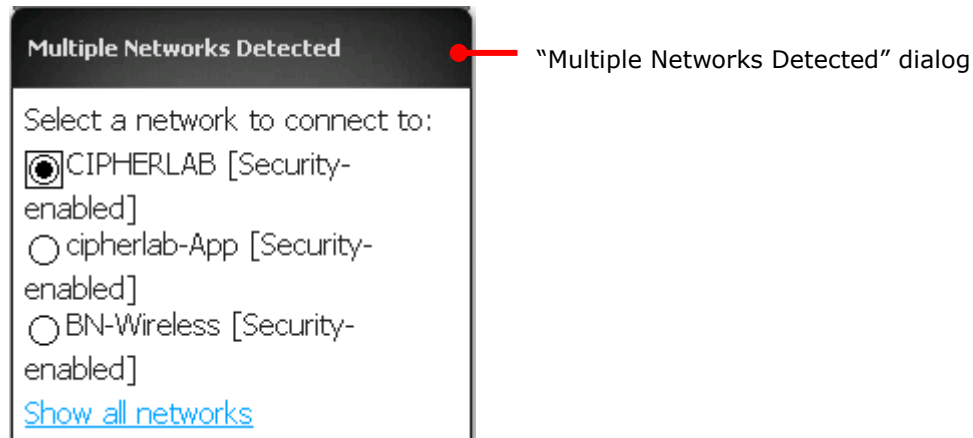
Once Wi-Fi is on, the mobile computer starts scanning for the available Wi-Fi networks within its reach. The O.S. shortly displays a "Multiple Networks Detected" dialog prompting a few names of those found.



If the "Multiple Networks Detected" dialog doesn't show, tap Title bar to open Drop-down bar and tap  icon to display the dialog.

WI-FI CONNECTION SETUP

Once Wi-Fi is on as described in [Enable/Disable Wi-Fi](#), proceed to set up a Wi-Fi connection. There are two approaches:

- 1) From "Multiple Networks Detected" dialog, tap the Wi-Fi network to connect.
- 2) Tap the "OK" command on Softkey bar.
- 3) Select where the selected network connects to.

Select **The Internet** if you're using the network to access Internet; or select **Work** if you're using the network to access an internal network, i.e. the work network (the intranet).





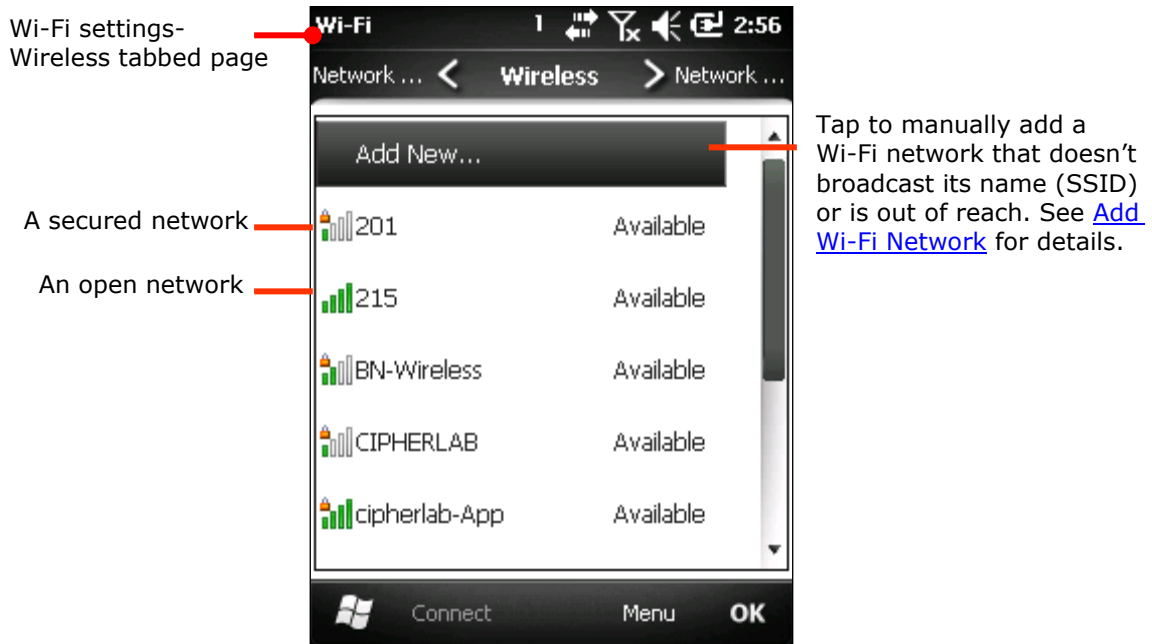

- 4) Tap the "Connect" command on Softkey bar.
- 5) Enter the network key if required.
- 6) Tap the "Connect" command on Softkey bar.

OR

- 1) From “Multiple Networks Detected” dialog, tap **Show all networks** link to bring all detected networks into view.

Wi-Fi settings open showing **Wireless** tabbed page. It displays both open and secured networks with signal strength. Secured networks have a lock graphic on them. 



Icon	Description
 (no-bar)	Signal strength (RSSI) is -91 dBm or weaker.
 (one-bar)	Signal strength (RSSI) is -90 dBm to -82 dBm.
 (two-bar)	Signal strength (RSSI) is -81 dBm to -72 dBm.
 (three-bar)	Signal strength (RSSI) is -71 dBm to -68 dBm.
 (four-bar)	Signal strength (RSSI) is -67 dBm or stronger.
 (secured)	A secured network with signal strength.
 (fail)	No signal for this network.

Note if the mobile computer detects a network connected to previously, it auto-connects to it.

2) Tap the network to connect.

"Configure Wireless Network" page opens.

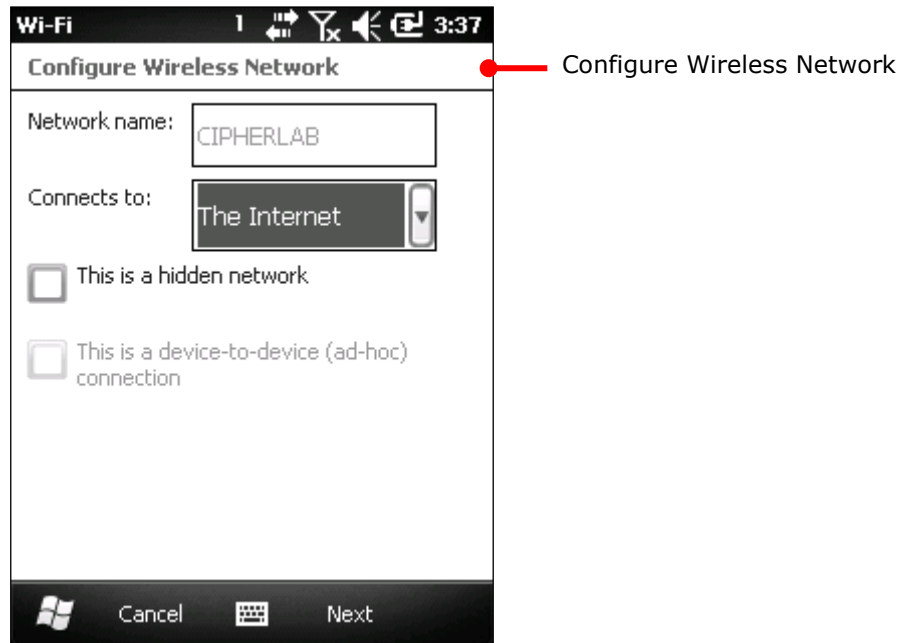

For **Connects to**, select between **The Internet** and **Work**. Select **The Internet** if you're using the network to access the Internet; or select **Work** if you're using the network to access an internal network, i.e. the work network (the intranet).

Select **This is a hidden network** if the network doesn't broadcast its name.

If you're adding a hidden network, see [Add Wi-Fi Network](#).

3) Tap **Next** to proceed.

"Configure Network Authentication" page opens.

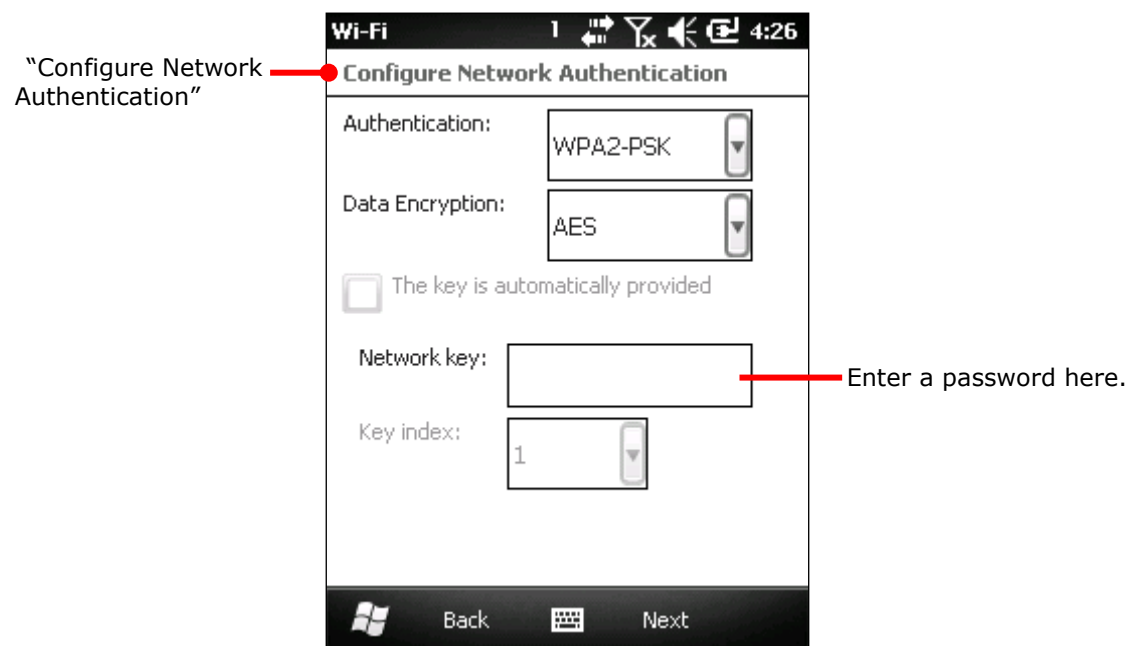

If the network to connect to is secured, you're prompted to enter a password or other credentials. Ask your network administrator for the details.

- 4) Tap **Next** to proceed.
- 5) Follow onscreen instruction to follow through the setup.

When setup finishes, the mobile computer tries to connect to the Wi-Fi network set and reopens Wireless tabbed page. Once connected, the network displays "Connected". To edit it, tap & hold it.

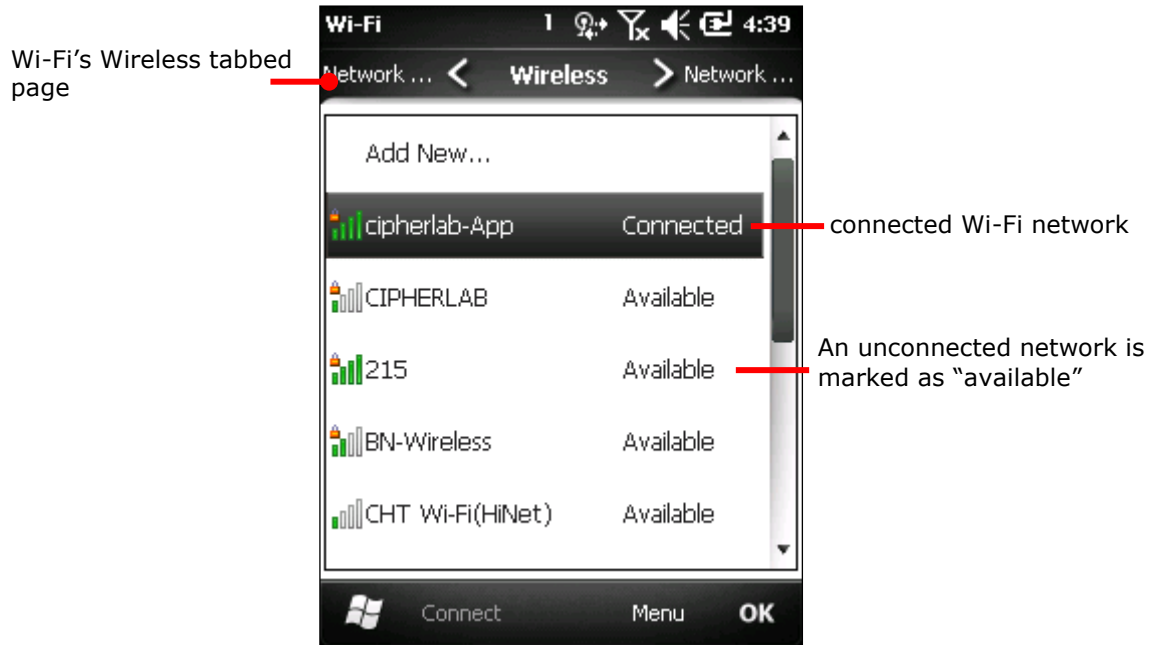

On Wireless Manger screen, Wi-Fi entry will show the name of the connected network.

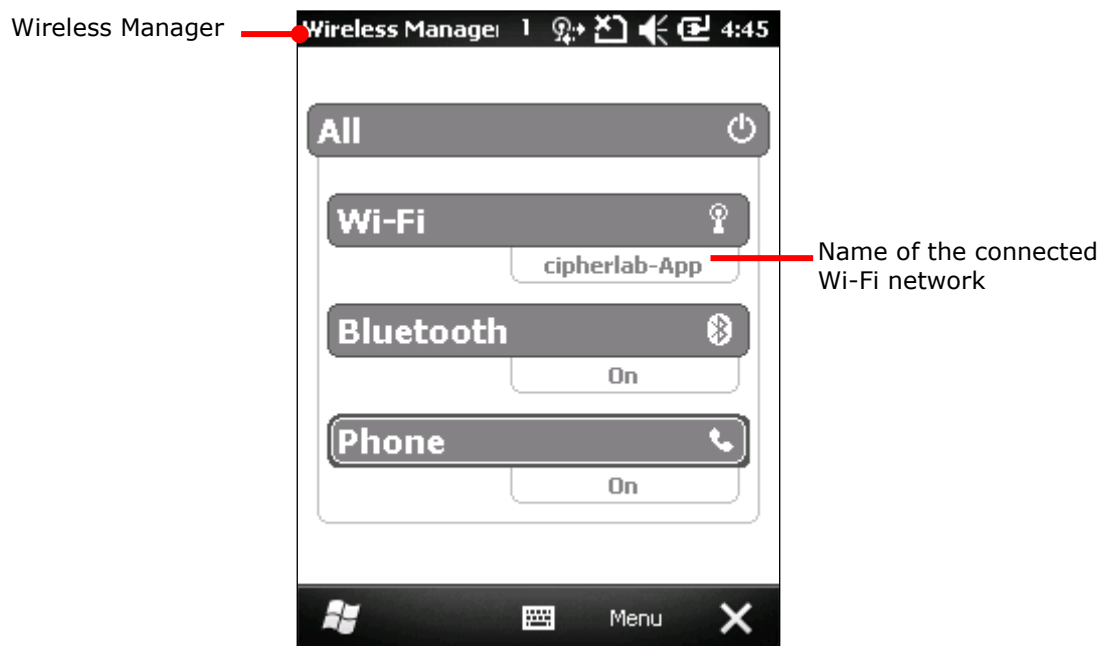

CONNECT ANOTHER WI-FI NETWORK

To connect to another Wi-Fi network:

- 1) Open Wi-Fi's Wireless tabbed page. (Start screen | **Settings** | **Connections** | **Wireless Manager** | Softkey bar "Menu" command | **Wi-Fi Settings**.)

Wi-Fi's Wireless tabbed page opens.

- 2) Tap & hold the Wi-Fi network to connect that is available but unconnected (marked as "Available").

Context menu opens.

- 3) Tap **Connect**.
- 4) Follow onscreen instructions to proceed.

EDIT WI-FI NETWORKS

To edit a Wi-Fi network:

- 1) Open Wi-Fi's Wireless tabbed page. (Start screen | **Settings** | **Connections** | **Wireless Manager** | Softkey bar "Menu" command | **Wi-Fi Settings**.)

- 2) Tap & hold the Wi-Fi network to edit.

Context menu opens.

- 3) Tap **Edit**.
- 4) Follow onscreen instructions to proceed.

FORGET WI-FI NETWORKS

To forget a Wi-Fi network:

- 1) Open Wi-Fi's Wireless tabbed page. (Start screen | **Settings** | **Connections** | **Wireless Manager** | Softkey bar "Menu" command | **Wi-Fi Settings**.)

- 2) Tap & hold the Wi-Fi network to forget that is previously connected.

Context menu opens.

- 3) Tap **Remove Settings**.
- The Wi-Fi network is forgotten.

RECEIVE NOTIFICATIONS OF AVAILABLE NETWORKS

When Wi-Fi is enabled, the mobile computer issues notifications on Title bar to report available Wi-Fi network detected. This report is enabled by default. In case you need to disable it:

- 1) Turn on Wi-Fi as described in [Enable/Disable Wi-Fi](#).
- 2) On Wi-Fi's Wireless tabbed page, tap the "Menu" command on [Softkey bar](#).

Option menu opens.

3) Tap **Advanced**.

Wi-Fi's Advanced settings open:

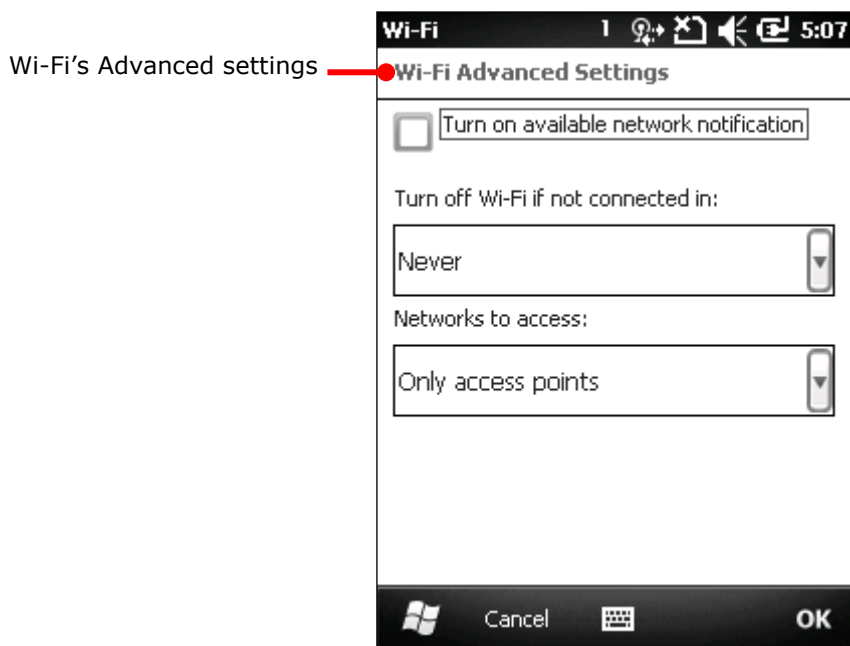
4) Deselect **Turn on available network notifications**.

See also [Advanced Wi-Fi Settings](#).

ADD WI-FI NETWORKS

"Adding" Wi-Fi networks are usually needed for the following cases:

- ▶ when it doesn't broadcast its name (SSID), or
- ▶ when you're out of its wireless coverage

So the mobile computer can connect to it (in the former case), or remember it and connect to it once its wireless coverage becomes reachable (in the latter case).

To add a secured network, contact the network's administrator to learn the security scheme deployed and get the password or other required security credentials.

To add a Wi-Fi network:

- 1) Turn on Wi-Fi as described in [Enable/Disable Wi-Fi](#).
- 2) Open Wireless Manager, tap the "Menu" command on [Softkey bar](#).
Option menu opens.
- 3) Tap **Wi-Fi Settings**.
Wi-Fi's Wireless tabbed page opens.
- 4) Tap **Add New...** (, which is listed above all found networks)
- 5) Enter the SSID (name) of the network to add and configure the security deployed on it.
Enter any required security credentials.
- 6) Follow onscreen instructions to proceed.

The network is saved on the mobile computer. If it's out of reach, it appears unavailable  (fail) among the founded networks. If it is a hidden one, it is connected in a few seconds.

CONNECT BY STATIC IP

When the mobile computer connects to a Wi-Fi network by DHCP protocol, the mobile computer fetches a network address and other info needed from the network. But when you are connecting a Wi-Fi network by a fixed IP address, make the following setting:

- 1) Turn on Wi-Fi as described in [Enable/Disable Wi-Fi](#).
- 2) On Wi-Fi setting screen, tap **Network Adapters** tab.

Network Adapters tabbed page opens.

Wi-Fi's "Network Adapters" tabbed page

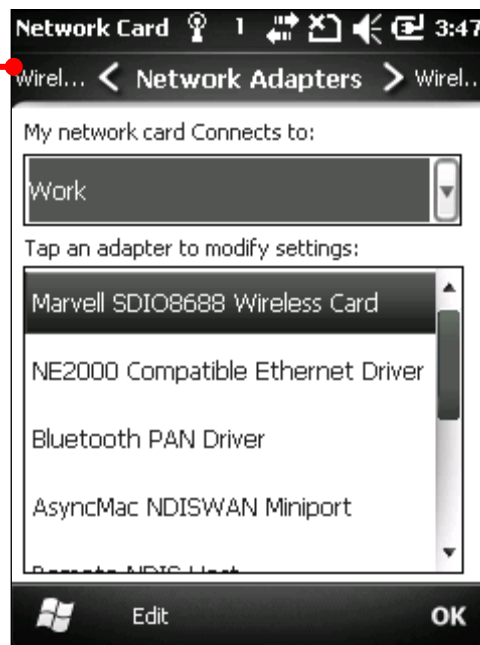

- 3) Tap the WLAN adapter, and tap the "Edit" command on [Softkey bar](#) to access the settings.

ADVANCED WI-FI SETTINGS

Access advanced Wi-Fi settings for the following:

- ▶ To turn on/off available network notifications.
- ▶ To set the time to turn off Wi-Fi after Wi-Fi connection keeps failing
- ▶ To set the network to access only hotspots or computer-to-computer (ad-hoc) or both.

To access advanced Wi-Fi settings:

- 1) Turn on Wi-Fi as described in [Enable/Disable Wi-Fi](#).
- 2) On Wi-Fi's Wireless tabbed page, tap the "Menu" command on [Softkey bar](#).

Option menu opens.

3) Tap **Advanced**.

Wi-Fi's advanced settings open.

Wi-Fi's advanced settings

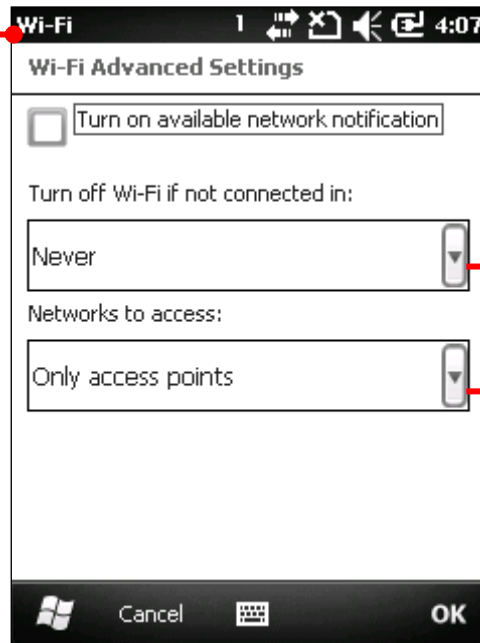

Sets the time to turn off Wi-Fi after Wi-Fi connection keeps failing

Sets the network to access

4) Make your desired setting.

USE BLUETOOTH



The mobile computer is Bluetooth-enabled to synchronize data with other devices such as PCs, car hands-free, headsets, printers, PDAs, and cell phones.

Bluetooth enables wireless connections over a short distance about 8 meters. It is specified in IEEE 802.15.1 as a “wireless personal area network” (WPAN).

To connect a Bluetooth device for the 1st time, the mobile computer needs to “pair” with it. Such “pairing” involves the authentication between two devices to justify their accesses to each other. After their initial pairing, they can connect to each other without pairing.

STATUS ICONS

Bluetooth status icons:

Status Icon	Description
	Bluetooth in use (data transmission ongoing)
	Bluetooth headset in use

CHANGE BLUETOOTH NAME

By default the mobile computer has the device name for its Bluetooth name and isn't visible to other devices. Change the name if it isn't recognizable enough.

To change the mobile computer's Bluetooth name:

- 1) On Start screen, tap **Settings** | **System** | **About**  .
About screen opens showing Version tabbed page.
- 2) Tap **Device ID** tab.
Device ID tabbed page opens.
- 3) Enter a name following the prompted rule.
- 4) Tap the “OK” command on Softkey bar to apply the change and quit setting.

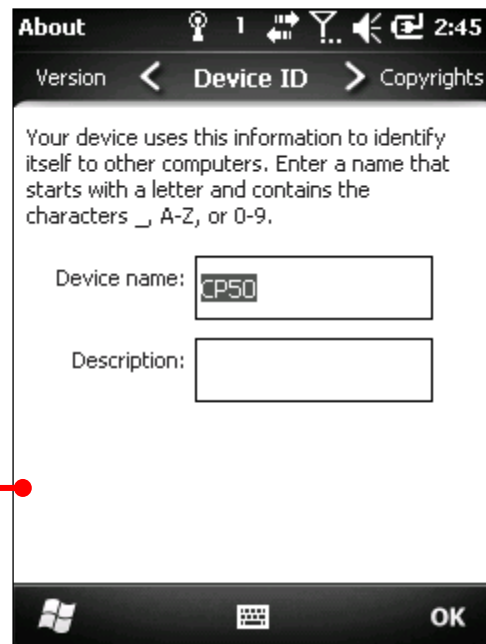

Device ID tabbed page 

EXPOSE MOBILE COMPUTER

In default state the mobile computer is hidden from other Bluetooth devices. To come clean about the mobile computer, make the following setting:

- 1) On Start screen, tap **Settings | System | Bluetooth**.
Bluetooth settings open showing Devices tabbed page.
- 2) Tap **Mode** tab.
Mode tabbed page opens.

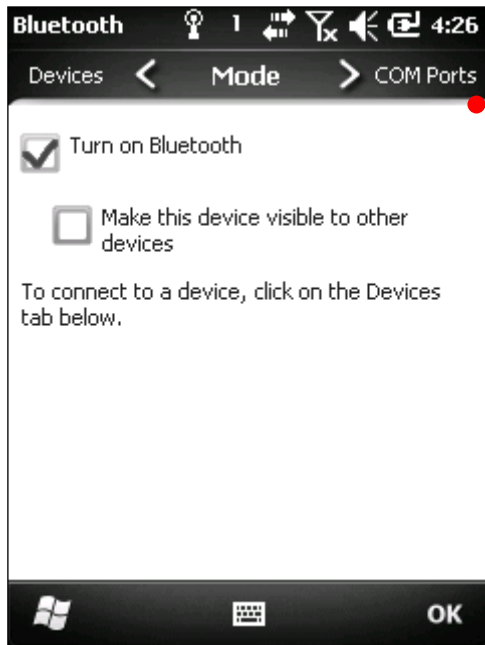

Bluetooth's Mode tabbed page

- 3) Select **Make this device visible to other devices**.
- 4) Tap the "OK" command on [Softkey bar](#).

The mobile computer becomes discoverable by other Bluetooth devices.

On Wireless Manager screen, the Bluetooth entry show a "Visible" label.

Bluetooth entry show a "Visible" label on Wireless Manager screen



TURN ON/OFF BLUETOOTH

To turn on/off Bluetooth:

- 1) On Start screen, tap **Settings | Connections | Wireless Manager** .
Wireless Manager opens.
- 2) Tap the **Bluetooth** entry.
Bluetooth powers on.

OR

- 1) On Start screen, tap **Settings | Bluetooth**.
Bluetooth's Devices tabbed page opens.
- 2) Tap **Mode** tab.
Mode tabbed page opens.
- 3) Select **Turn on Bluetooth**.
- 4) Tap the "OK" command on Softkey bar.
Bluetooth powers on.

PAIR & CONNECT BLUETOOTH DEVICES

Before the mobile computer can connect another Bluetooth device, it needs to pair with that device first. Once they are paired, they stay paired unless they are unpaired.

To pair with & connect to a Bluetooth device:

- 1) On the mobile computer, turn on Bluetooth as described in [Turn on/off Bluetooth](#).
- 2) On Start screen, tap **Settings | Bluetooth**.

Bluetooth settings open showing Devices tabbed page.



Bluetooth's Devices tabbed page

3) Tap **Add new device...**

The mobile computer scans and displays the names of all Bluetooth devices found within reach.

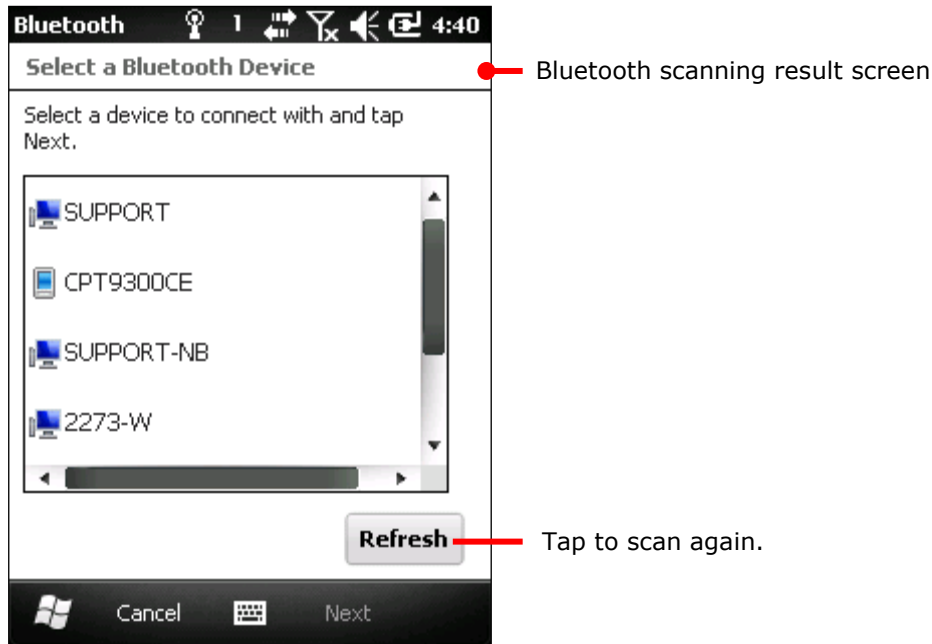

If the device to pair with doesn't display, make it discoverable. If the mobile computer stops scanning before the device to connect becomes discoverable, tap **Refresh**.

4) Tap the name of the device to connect that is found. Tap **Next**.

The two devices pair with each other. You may be asked for a passcode for a secure connection. Try entering 0000 or 1234 (the most common passcode). Sometimes you need to consult the other Bluetooth devices' documentation for this code.

Some devices are paired and connected at once depending on the Bluetooth feature(s) in use. Once the device is paired (and connected), you are prompted by a dialog.

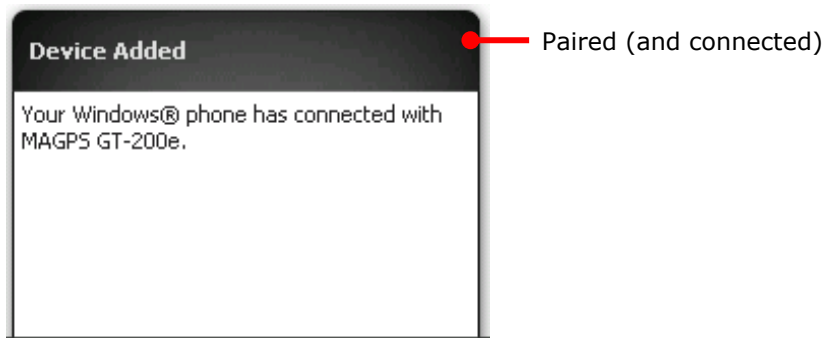

- 5) Tap the “Done” command on [Softkey bar](#).

OR

Tap the “Advan...” command on [Softkey bar](#), which only briefly shows, to configure the Bluetooth features to use with that device. Then tap **Save**.

Devices tabbed page re-opens listing the just connected Bluetooth device among others.

A device connected is listed under **Connected** label. A paired but unconnected device is listed under **Disconnected** label.

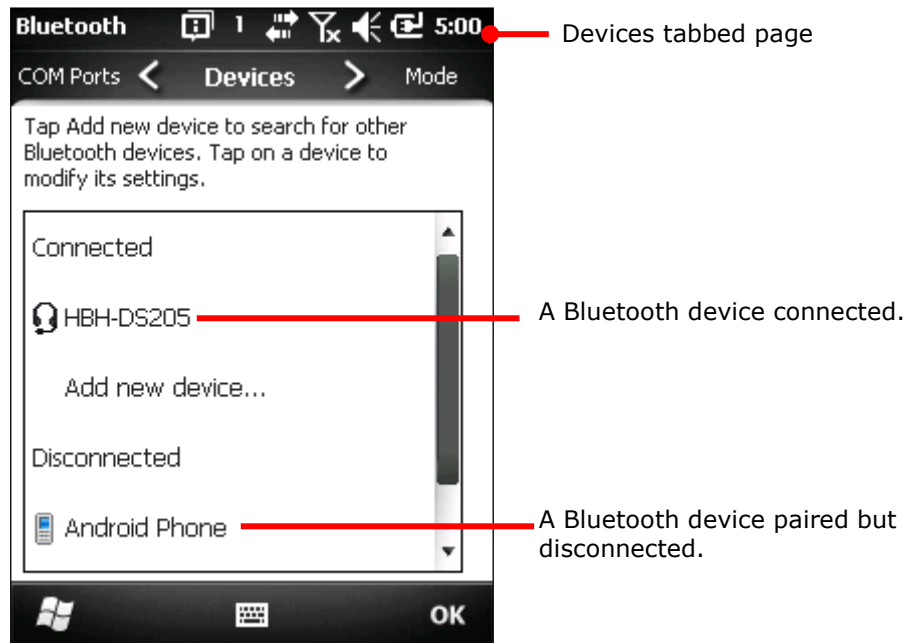

- 6) Tab & hold a connected device to edit its Bluetooth features to use, or disconnect or delete (unpair) it.

OR

Tap & hold a disconnected device to edit the Bluetooth features to use, reconnect it, or delete (unpair) it.

See also [Disconnect Bluetooth Devices](#), [Unpair Bluetooth Device](#), and [Edit Bluetooth Features to Use](#).

DISCONNECT BLUETOOTH DEVICES

To disconnect the mobile computer from a Bluetooth device, there are two approaches:

Simply turn off the Bluetooth as described in [Turn on/off Bluetooth](#). The mobile computer is disconnected from all connected Bluetooth devices.

OR

- 1) Open Bluetooth settings. (Start screen | **Settings** | **Bluetooth** or Start screen | **Settings** | **Connections** | **Wireless Manager** | “Menu” command on Softkey bar | **Bluetooth Settings**.)

Bluetooth settings open showing Devices tabbed page.

- 2) Tap & hold the device to disconnect from.

Context menu opens.

- 3) Tap **Disconnect**.

The mobile computer is disconnected from the Bluetooth device.

UNPAIR BLUETOOTH DEVICES

To unpair a Bluetooth device:

- 1) Open Bluetooth settings. (Start screen | **Settings** | **Bluetooth**.)

Bluetooth settings open showing Devices tabbed page.

- 2) Tap & hold the device to unpair from.

Context menu opens.

- 3) Tap **Delete**.

The Bluetooth device is unpaired. The mobile computer needs to pair with it again to reconnect it.

RECONNECT BLUETOOTH DEVICES

Before the mobile computer reconnects a Bluetooth device, make sure the two devices are paired and within each other's wireless reach.

To reconnect a Bluetooth device:

- 1) Open Bluetooth settings. (Start screen | **Settings** | **Bluetooth**.)

Bluetooth settings open showing Devices tabbed page.

- 2) Tap & hold the device to reconnect (normally under **Disconnected** label).

Context menu opens.

- 3) Tap **Connect**.

The Bluetooth device is reconnected and its name displays under **Connected** label.

EDIT BLUETOOTH FEATURES TO USE

A Bluetooth profile defines the features and communications supported by a Bluetooth device. For two Bluetooth devices to share files with each other, they need to both support the due profiles. Some Bluetooth devices have multiple profiles. Profiles can cover the ability to transmit phone conversations, to play music in stereo, or to transfer files or other data. The mobile computer enables configuring the profiles you want to use on the mobile computer.

- 1) Open Bluetooth settings. (Start screen | **Settings** | **Bluetooth**.)

Bluetooth settings open showing Devices tabbed page.

- 2) Tap & hold the device to configure.

Context menu opens.

3) Tap **Edit**.

Partnership Settings opens listing the device's available profiles.

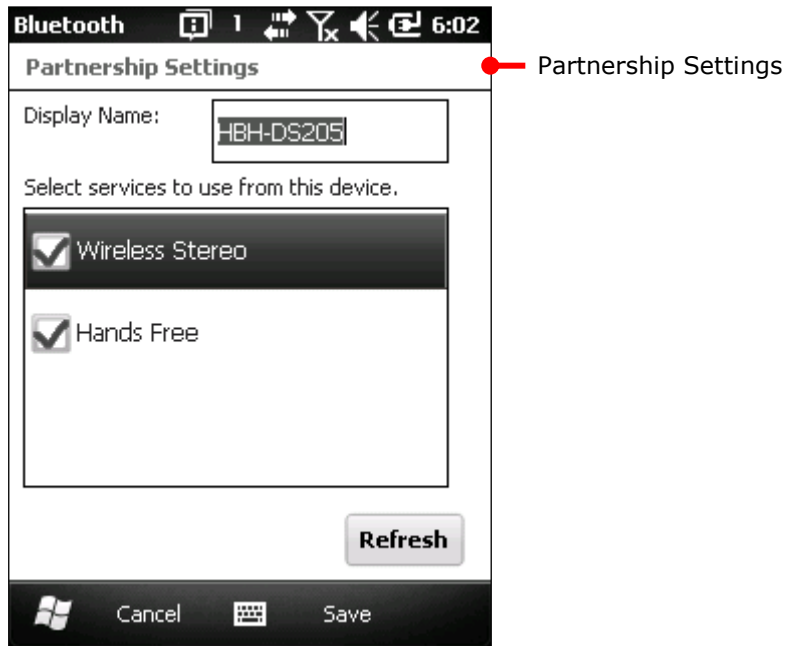

4) Select or deselect a profile to use it or not.

BLUETOOTH FILE EXCHANGE

Once connected with other devices using Bluetooth, the mobile computer can offload or download files to/from them. Basically it relies on File Explorer  to get it done.

OFFLOAD FILES

- 1) On the mobile computer, turn on Bluetooth as described in [Turn on/off Bluetooth](#) if you haven't.
- 2) Open File Explorer .
- 3) Browse for the file to offload.
- 4) Tap & hold the file to offload.
Context menu comes up.

5) Tap **Beam File...**

The Bluetooth application generates a list of Bluetooth devices found.

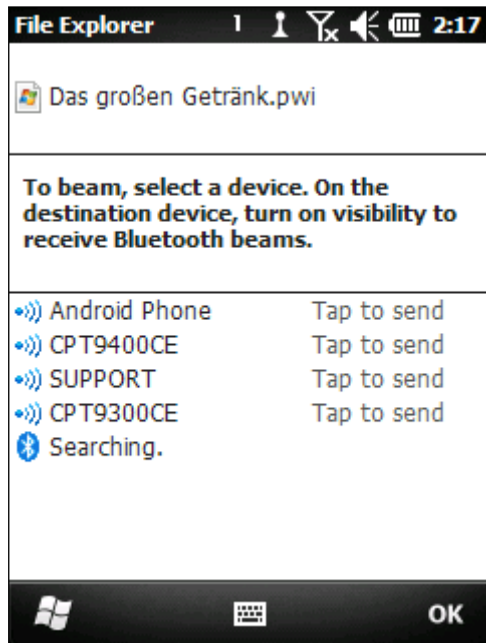

6) Select the device to offload the file to.

The device will receive a notification asking for confirmation to accept the file.

7) Confirm accept.

The device proceeds to receive it inbound.

DOWNLOAD FILES

For the mobile computer to download files from other devices using Bluetooth, "Beam mode" must be enabled first:

To enable Beam mode:

- 1) On Start screen, tap **Settings | Connections | Beam** .
- 2) Select **Receive all incoming beams**.

To download files from other devices using Bluetooth:

- 1) Enable the mobile computer's "Beam" as mentioned above.
- 2) Turn on Bluetooth as described in [Turn on/off Bluetooth](#) if you haven't.
- 3) Make the mobile computer discoverable as mentioned in [Expose Mobile computer](#).

The mobile computer readies to receive an inbound file with Bluetooth. The mobile computer asks if you what to accept the file when it is coming in.

4) Confirm **Yes** or **No**.

The file is saved to the mobile computer or rejected.

See also [Beam](#).

BLUETOOTH ACTIVESYNC

The advantage of Bluetooth ActiveSync is to save the trouble perpetually switching between multiple devices by changing cables or adapters.

Note to disable network bridging on your PC (specifically bridging to a Remote NDIS adapter) before connecting Bluetooth ActiveSync. For more information on network bridging, see Windows Help on the PC.

To use ActiveSync using Bluetooth:

- 1) Note the virtual Bluetooth COM port on your PC. If your PC doesn't have any, add one.
- 2) Run ActiveSync on your PC. From the menu bar, click **File | Connection Settings**.
- 3) Deselect **Allow USB connection** and select **Allow connections to one of the following**.
- 4) Select the COM port you noted in step 1.
- 5) Hit OK button to apply change and quit setting.

- 6) On the mobile computer, tap **ActiveSync**  from Start screen.

ActiveSync opens. If this is your first time opening it, it shows some guidelines to set up sync, ignore whatever the screen says. Proceed as described in the following.

- 7) Tap the "Menu" command on [Softkey bar](#).

Option menu opens.

- 8) Tap **Connect via Bluetooth**.

For 1st setup, you are prompted to set up Bluetooth partnership with your PC,

- 9) Tap **Yes**.

You are taken to Bluetooth's Mode tabbed page.

- 10) Turn on Bluetooth if you haven't.

- 11) Tap **Device** tab.

Bluetooth's Device tabbed page open.

- 12) For the 1st setup, tap **Add new device** and complete through pairing and connection as described in [Pair & Connect Bluetooth device](#).

OR

Select the name of your PC if it is connected before.

Once paired and/or connected, you are taken back to Device tabbed page.

- 13) Reopen **ActiveSync**  on the mobile computer.

- 14) Tap the "Menu" command on Softkey bar.

Option menu opens.

- 15) Tap **Connect via Bluetooth**.

Bluetooth connection is established within a few seconds. ActiveSync on your PC opens its **Sync Setup Wizard**.

- 16) Set up the sync partnership you desire. See [1st USB Sync](#) for the setting.

DISCONNECT BLUETOOTH ACTIVESYNC

To disconnect Bluetooth ActiveSync:

- 1) On the mobile computer, tap **ActiveSync**  from Start screen.
ActiveSync opens.
- 2) Tap the "Menu" command on [Softkey bar](#).
Option menu opens.
- 3) Tap **Disconnect**.
- 4) Press the "OK" command to apply the change and quit setting.
Bluetooth ActiveSync is disconnected.

BLUETOOTH INTERNET SHARING

As mentioned in [USB Internet Sharing](#), "Internet Sharing" or "Internet Tethering" enables a Windows-based PC to connect to Internet using the mobile computer's mobile data (or other dial-up). Well "Internet Sharing" is supported by Bluetooth too. To tether to Internet using Bluetooth, make the follow setting:

- 1) Set up Bluetooth connection between the mobile computer and your PC as described in [Pair & Connect Bluetooth device](#).
- 2) On the mobile computer, tap **Internet Sharing**  from Start screen.
Internet Sharing opens.

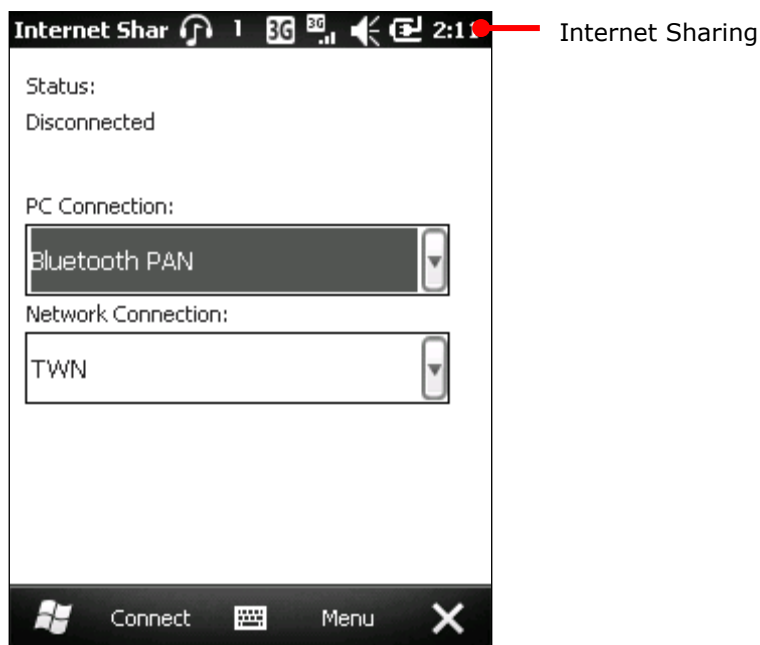

- 3) Select **Bluetooth PAN** for **PC Connection**, and select your wireless service for **Network Connection**.
- 4) Tap the "Connect" command on Softkey bar.

- 5) On your PC, set up a **Bluetooth Personal Area Network** with the mobile computer. Setting up a Bluetooth PAN varies between different Bluetooth utilities. Consult the documentation of your Bluetooth utility or Windows Help on your PC to know about the setup.

In a few seconds Internet Sharing prompts "Connected" on the mobile computer. Your PC connects to Internet.

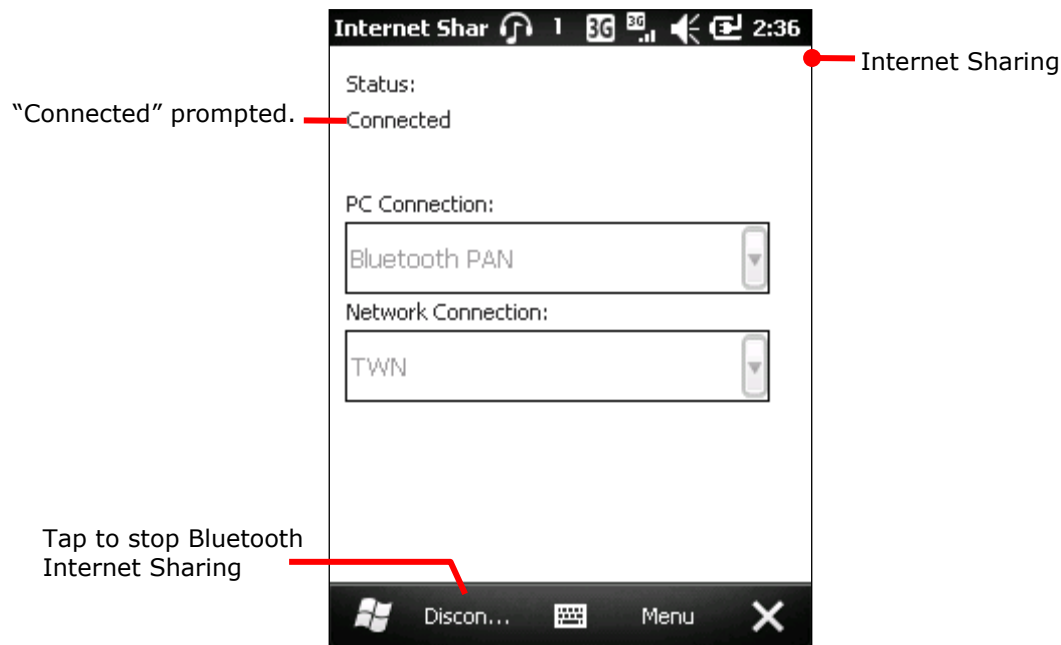

Tap the "Discon..." command on Softkey bar to stop.

For the internet sharing using USB, see [USB Internet Sharing](#).

Compare [Bluetooth Pass-through Networking](#) & [USB Pass-through Networking](#).

BLUETOOTH PASS-THROUGH NETWORKING

"Pass-Through Networking" enables the mobile computer to network using your PC's data connection, courtesy that two computers are synced, whether by a hardwired USB approach or wirelessly by Bluetooth.

- 1) Establish sync partnership between the mobile computer and your PC using Bluetooth as described in [Bluetooth ActiveSync](#).
- 2) On your PC, from the menu bar of ActiveSync, select **File | Connection Settings**.
Connection Settings open.
- 3) For **This computer is connected to**, select a connection to which your PC should connect when passing through ActiveSync.
- 4) Select **Open ActiveSync when my device connects**.
- 5) Press **OK** button to apply the change and quit setting.

You can proceed to network on the mobile computer.

For the pass-through networking with USB, see [USB Pass-through Networking](#).

Compare [Bluetooth Internet Sharing](#) & [USB Internet Sharing](#).

CONNECT TO VIRTUAL PRIVATE NETWORKS

Virtual Private Networks (VPN) are a group of individual networks on a public network (such as the Internet) that connect to each other by private lines and communicate among themselves by encryption technology so their data are kept safe from unauthorized access. VPN is the infrastructure commonly adopted by corporations so their users can access corporate network resources when they are not in offices or tripping out of town.

The mobile computer supports VPN connection to access the resources inside a secured network from the outside.

There is a variety of security protocols for VPN. Some work based on secure certificates while others requires passwords to permit the access. To access a VPN with secure certificates, see [Install Secure Certificates](#).

To be able to set up a VPN connection on the mobile computer, obtain the needed credentials from your network administrator, and note VPN is always accessed via mobile data connection, i.e. the mobile computer's HSPA+.

VPN CONNECTION SETUP

To add a VPN connection to the mobile computer:

- 1) On Start screen, tap **Settings | Connections | Connections (Manager)**  .
Connections (Manager) opens showing Tasks tabbed page.

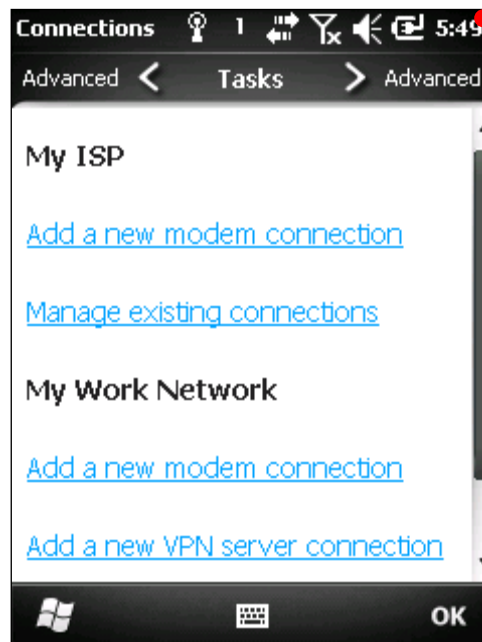

Connections (Manager) opens showing Tasks tabbed page.

- 2) Under **My Work Network** label, tap **Add a new VPN server connection**.

"Make New Connection" page opens.

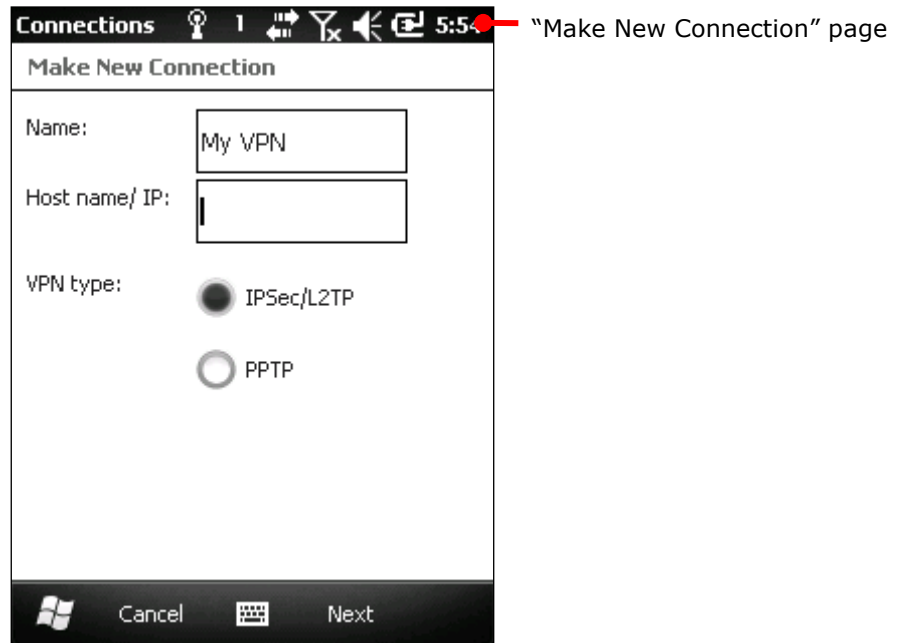

- 3) Complete each VPN settings. Consult your network administrator for the protocol employed on the VPN and other requested credentials.
- 4) Follow onscreen instructions to proceed.

Once a VPN connection is set up, a link **Edit my VPN servers** shows up under **My Work Network** label.

Proceed to connect your VPN as described in [Connect VPN](#).

CONNECT VPN

After a VPN connection is set up as described in [VPN Connection Setup](#), a link **Edit my VPN servers** shows up under **My Work Network**. Move on to connect to the prospective VPN.

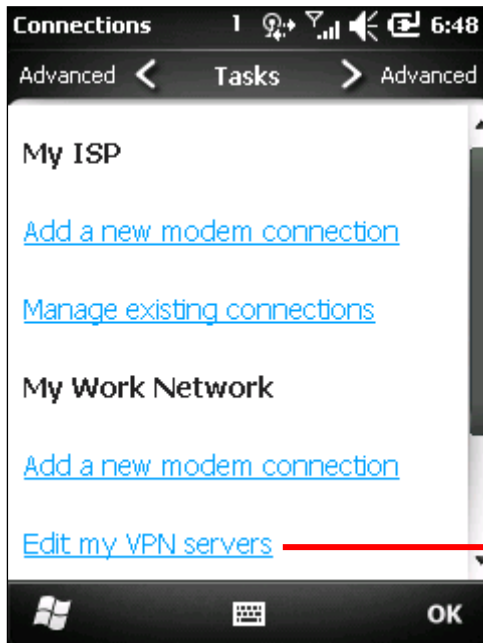

A link **Edit my VPN servers** shows up.

To connect VPN:

- 1) Tap **Edit my VPN servers** link.

My Work Network opens showing VPN tabbed page.

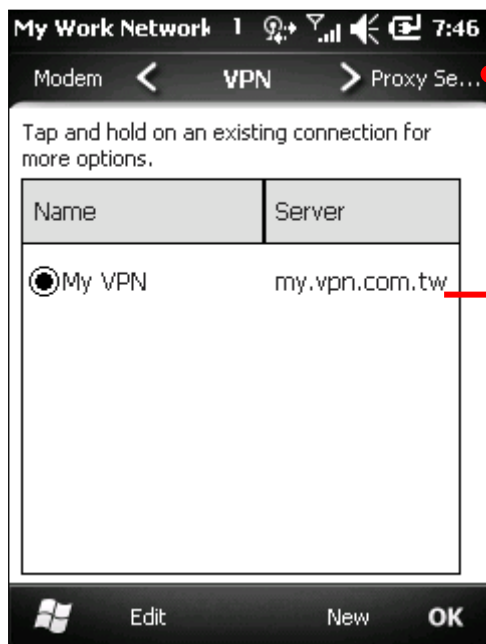

My Work Network's VPN tabbed page

Tap & hold to pop up context menu.

- 2) Tap & hold the VPN to connect.

Context menu shows up.

3) Tap **Connect**.

A dialog briefly displays noticing the attempt to connect.

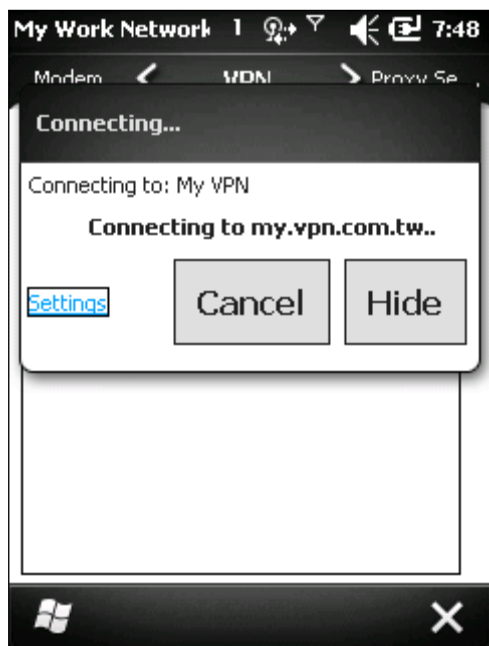

In a few seconds, the VPN is connected. Once connected, the mobile computer makes a sound as per [Sounds & Notifications](#) settings.

DISCONNECT VPN

The O.S. doesn't feature any facility or mechanism to disconnect VPN, consider using a third-party application to disconnect VPN.

EDIT A VPN

To edit a VPN:

- 1) On Start screen, tap **Settings | Connections | Connections (Manager)**  .
Connections (Manager) opens showing Tasks tabbed page.
- 2) Tap **Edit my VPN servers** link.
My Work Network's VPN tabbed page opens.
- 3) Select the VPN to edit.
- 4) Tap the "Edit" command on [Softkey bar](#).
- 5) Follow onscreen instructions to follow through editing.

DELETE A VPN

To delete a VPN:

- 1) On Start screen, tap **Settings | Connections | Connections (Manager)**  .
Connections (Manager)'s Tasks tabbed page opens.
- 2) Tap **Edit my VPN servers** link.
My Work Network's VPN tabbed page opens.
- 3) Tap & hold the VPN to edit.
Context menu shows up.
- 4) Tap **Delete**.
The VPN is deleted.

INSTALL SECURE CERTIFICATES

To connect to a VPN or Wi-Fi network that deploys secure certificates, the mobile computer must have these certificates. Where the mobile computer stores these secure certificates is called "certificate store".

Windows Embedded Handheld 6.5 has three "certificate stores" – the Personal, Intermediate and Root certificate stores. A certificate store usually has numerous certificates, possibly issued from a number of different certification authorities. To view the certificates stored on the mobile computer, see [View Secure Certificates](#).

SUPPORTED CERTIFICATE FORMATS

Windows Embedded Handheld 6.5 supports installing the following certificate formats:

- ▶ .PFX/.P12 – Public-Key Cryptography Standards #12 (PKCS #12): This file format includes personal certificates with private keys. They install into the intermediate and root certificate stores.
- ▶ CER – Base64-encoded or DER-encoded X.509 certificates that install into the intermediate and root certificate stores.
- ▶ P7B - Public-Key Cryptography Standards #7 (PKCS #7) format files that install multiple certificates to any certificate store on the device.

Certificates with their features:

File Type	Private Key Support	Installs a certificate chain	Installs only one certificate	Installs multiple certificates (can include chains)
.PFX/.P12	Yes	Optional	Optional	Yes
.CER	No	No	Yes	No
.P7B	No	Optional	Optional	Optional

Note: If you are referred to download a certificate from a website, you will be asked to set a password for the credential storage when you download it.

VIEW SECURE CERTIFICATES

Certificates  is the O.S.' featured tool to view to the "certificate stores" on the mobile computer.

To view the secure certificates:

On Start screen, tap **Settings** | **System** | **Certificates** .

Certificates open showing Personal certificate store.

See also [Certificates](#).

INSTALL SECURE CERTIFICATES

It is recommended that you install a certificate issued by a trusted authority. To install a secure certificate:

- 1) Copy the certificate file to the mobile computer first.
- 2) Browse for the file using File Explorer.
- 3) Tap the certificate file to install.

Certificate installer installs the file.

- 4) Follow the onscreen instructions to proceed.

Once the installation completes, it can be viewed in Certificates . (See [Certificates.](#))

LOCATION DISCOVERY

Adorned with a GPS module, the mobile computer is capable of finding your location on earth. GPS relies on the satellites covering the sky around the world to pinpoint your whereabouts. With mobile data (3.75G), the mobile computer even delivers A-GPS, which accelerates location discovery by combining GPS and cell-tower-distance triangulation. With 3.75G data, the mobile computer is also E911-compatible to get help for endangered 911 callers.

A location-aware application is necessary. CipherLab's [GPS Viewer](#) is preinstalled on the mobile computer for NMEA-based location discovery. There are other applications downloadable from Internet. Download the ".cab"-suffixed programs that confirm the compatibility with Windows Embedded Handheld 6.5. Note always download programs from trusted sources.

As GPS is a big power consumer, close GPS application when you are not using it.

LAUNCH GPS & AGPS

The O.S. doesn't feature any facility to turn on/off GPS module but a GPS intermediate driver (hereinafter "GPSID"), a software layer between GPS hardware and GPS software to stream GPS data from hardware to software without parsing NMEA syntax and in the meanwhile enable multiple applications to simultaneously access GPS data.

Hence the approach to turn on GPS module is to launch a GPS software or a location-aware application on the mobile computer because the software COM port for GPS is turned on then. In case of any difficulty launching GPS, open Start screen | **Settings** | **External GPS** | **Access** tabbed page to check if **Manage GPS automatically** is selected.

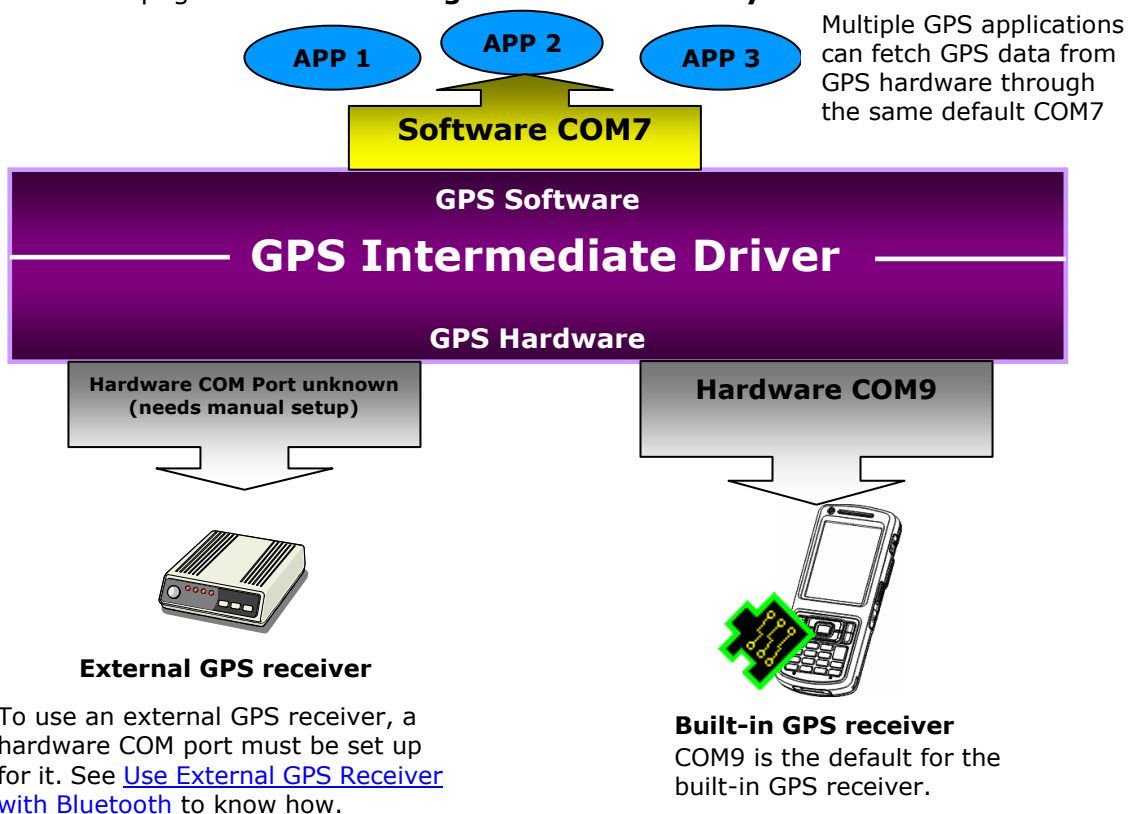

USE GPS & AGPS

To discover locations by GPS or AGPS:

- 1) Launch GPS & AGPS as described in [Launch GPS & AGPS](#).

Note to use AGPS, your mobile computer must have a 3.75G module and your network must support it.

- 2) Launch a GPS software or location-aware application.

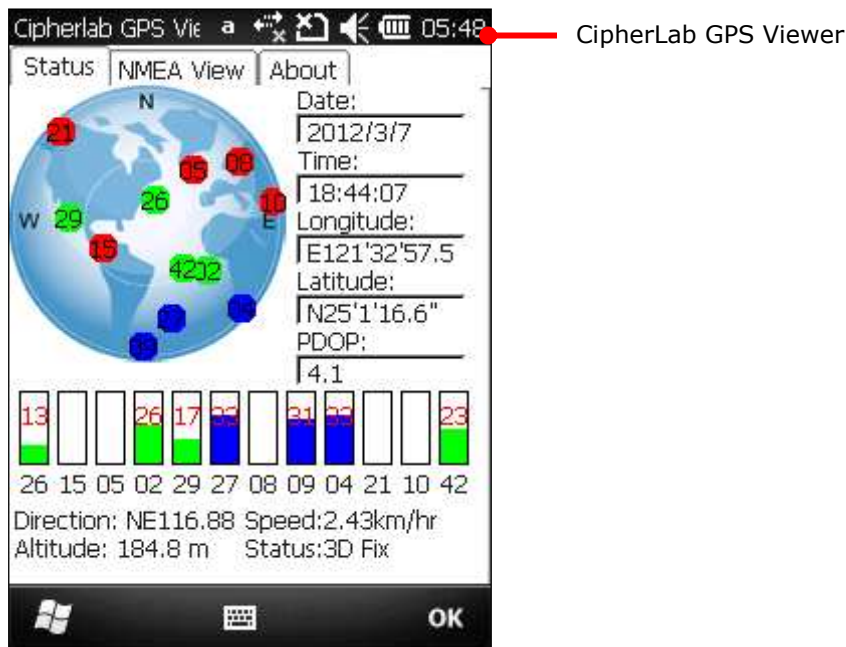

USE EXTERNAL GPS RECEIVER WITH BLUETOOTH

It involves a 2-phase setup to be able to use an external GPS receiver with Bluetooth on the mobile computer. The first phase is to set up a Bluetooth connection between your mobile computer and the external GPS receiver. The second phase is to set up the hardware COM port for the external GPS receiver with GPSID. The diagram presented in [Use GPS & AGPS](#) help you know why a COM port setup with the GPSID is needed. For the setup, we go step by step after the break:

- 1) Power on your external GPS receiver if you haven't.
- 2) On the mobile computer, open Start screen, tap **Settings | Connections | Wireless Manager** .

Wireless Manager opens.

- 3) Turn on Bluetooth by tapping the **Bluetooth** entry.

Bluetooth powers on.

- 4) Tap the "Menu" command on [Softkey bar](#).

Option menu opens.

5) Tap **Bluetooth Settings**.

Bluetooth settings open showing Devices tabbed page.

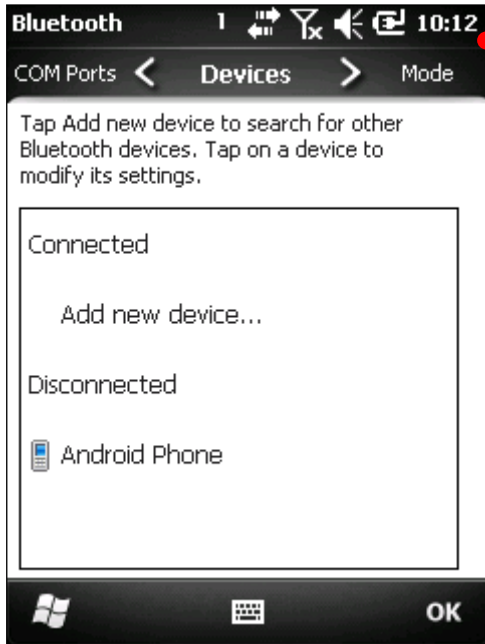

Bluetooth's Device tabbed page

6) Tap **Add new device...**

The setting application will search for the Bluetooth devices within wireless coverage. Then it generates a page listing those found.



Devices tabbed page

Tap your GPS receiver.

- 7) Select your GPS receiver and tap the "Next" command on Softkey bar.

Your GPS receiver may request for a passcode to create a secure connection. Enter a consistent code on both devices. Sometimes you need to consult your GPS receiver's documentation for this code.

Once two devices are connected, a dialog prompts.

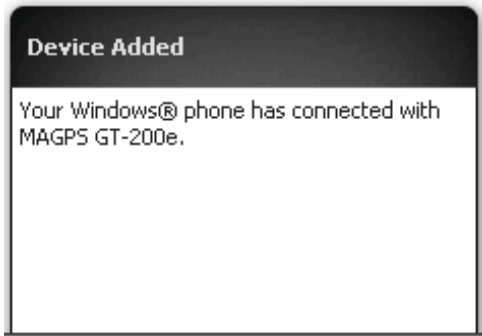

And Devices tabbed page opens again listing your GPS receiver. If it is paired but not connected, it is listed under **Disconnected** label. If it is paired and connected, it is listed under **Connected** label. Paired or paired & connected depends on the device's Bluetooth feature(s) enabled for the mobile computer at the moment.



Devices tabbed page reopens.

GPS receiver is paired but not connected.

- 8) Tap your GPS receiver.

Partnership Settings open.

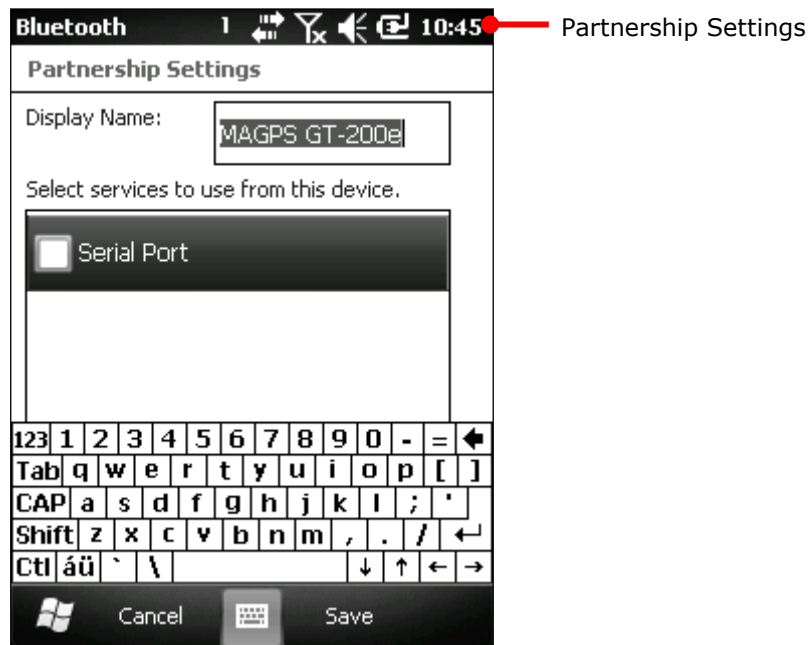

Select **Serial Port** and tap the "Save" command on Softkey bar.
Setting is saved and Device tabbed page re-opens.

- 9) Tap **Mode** tab.

Mode tabbed page opens.

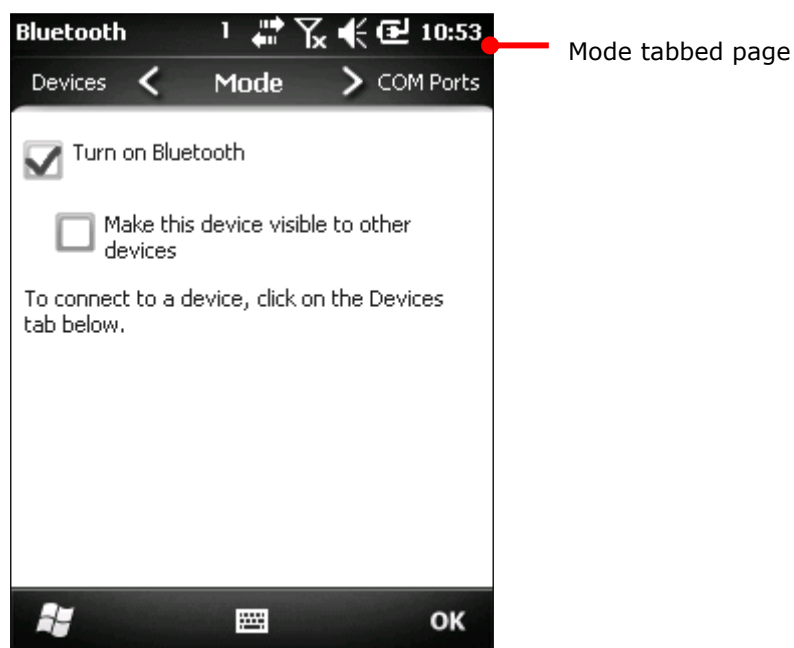

- 10) Select **Turn on Bluetooth** if it isn't selected.

11) Tap **COM Ports** tab.

COM Ports tabbed page opens.

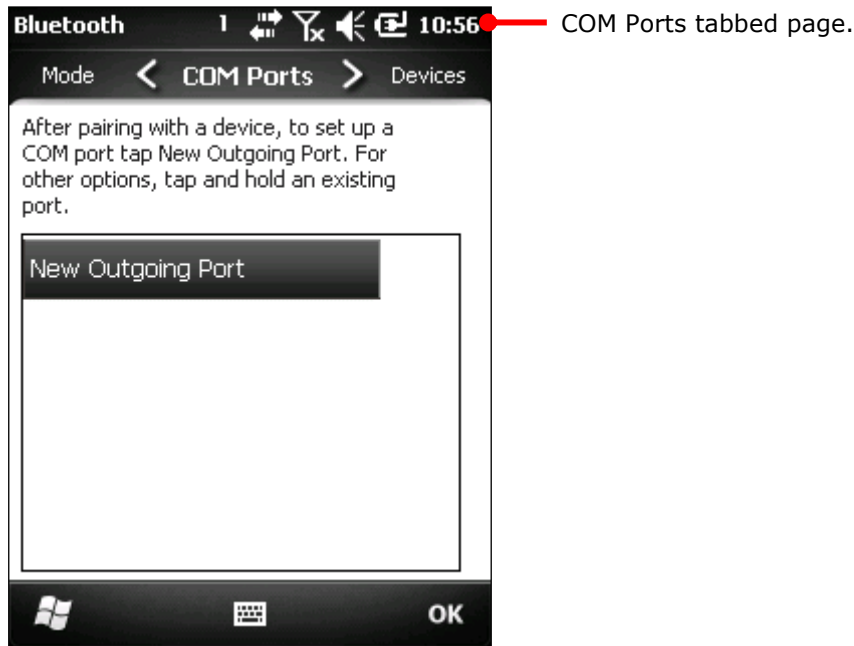

12) Tap **New Outgoing Port**.

Bluetooth's Add a Device page opens.

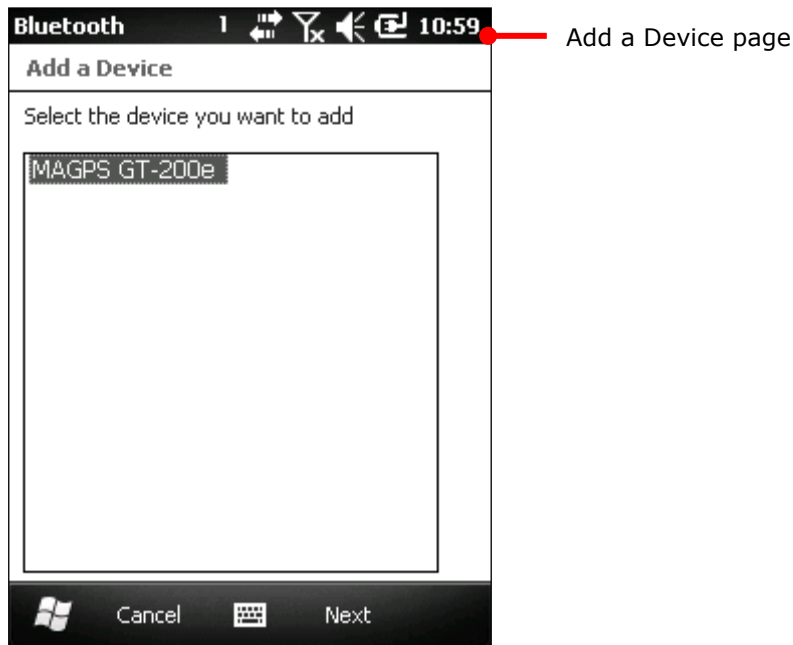

- 13) Select the GPS receiver and tap the "Next" command on Softkey bar.

A page opens showing a **Port** setting and a **Secure Connection** setting.

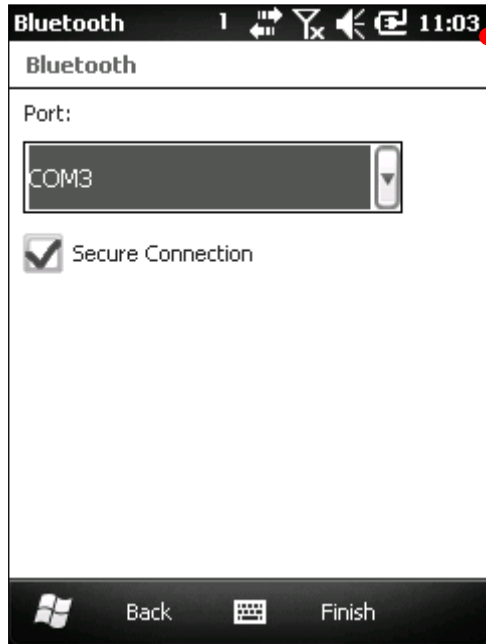

A page opens providing settings of COM port and security.

- 14) Select a port number (avoiding COM 7 and COM 9).

COM 7 is system's default GPS software COM port, and COM 9 is the hardware COM port for the built-in GPS receiver. As you are setting up a COM port for an external GPS receiver, you have to avoid said two.

Remember the port you choose. You will need it later to configure the intermediate software layer between the GPS hardware and software.

- 15) Tap the "Finish" command on [Softkey bar](#).

COM Ports tabbed page reopens showing your GPS receiver and the COM port assigned. Tap & hold the GPS receiver if you want to edit the COM port setting.

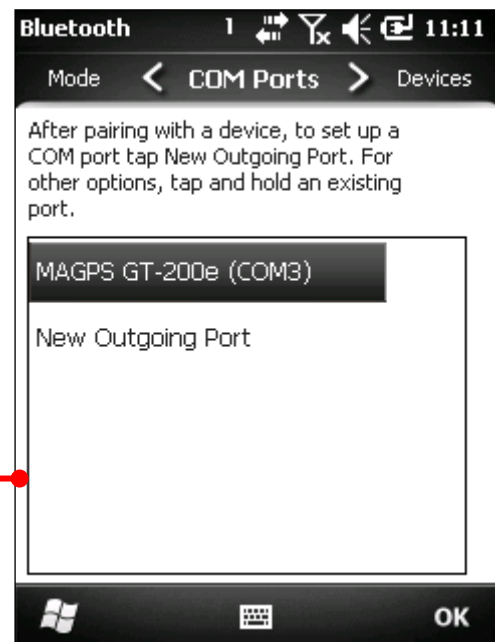

COM Ports tabbed page

16) Tap the "OK" command on Softkey bar to apply change and quit setting.

17) Open Start screen, tap **Settings | System | External GPS** .

GPS settings open showing Programs tabbed page.

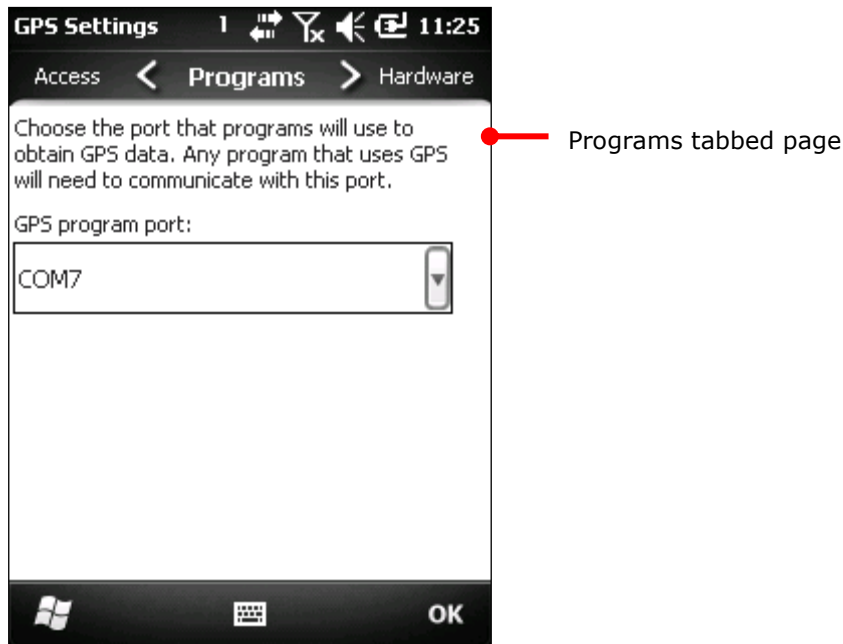

The page shows the virtual COM port for GPS applications set to COM7, the default. The GPS data sent to GPS software or location-aware applications is streamed through this port. Do not change the setting here.

18) Tap **Hardware** tab.

Hardware tabbed page opens showing GPS hardware port set to "COM9". As COM9 has been occupied by the built-in GPS receiver, set another COM port for your external GPS receiver. See the following to proceed.

Hardware tabbed page 

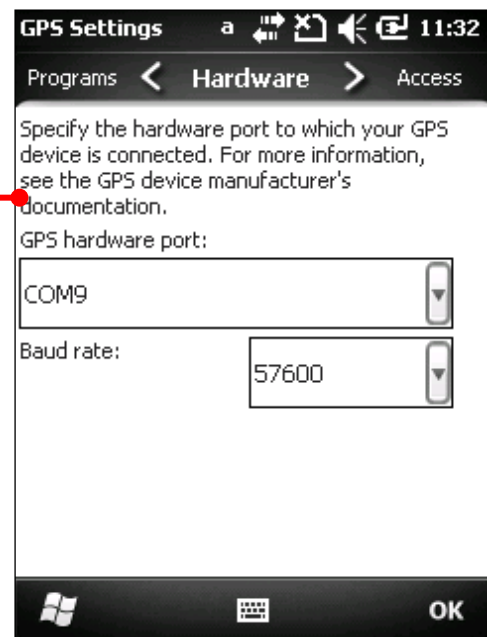

- 19) Select the COM port your external GPS hardware was configured to use as you have noted in step 14.

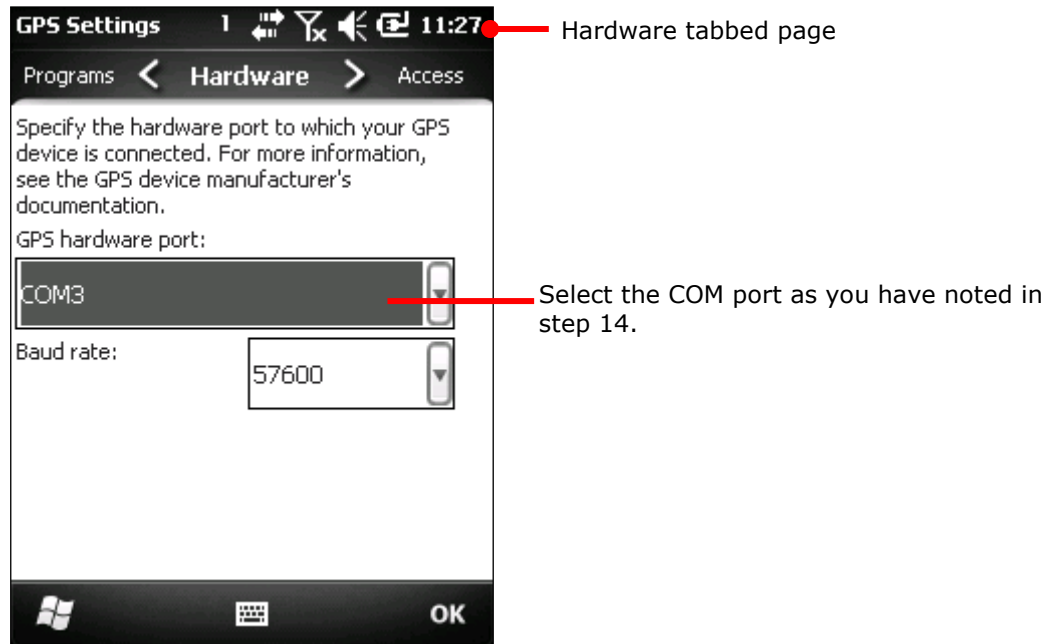

- 20) Tap **Access** tab.

Access tabbed page opens.

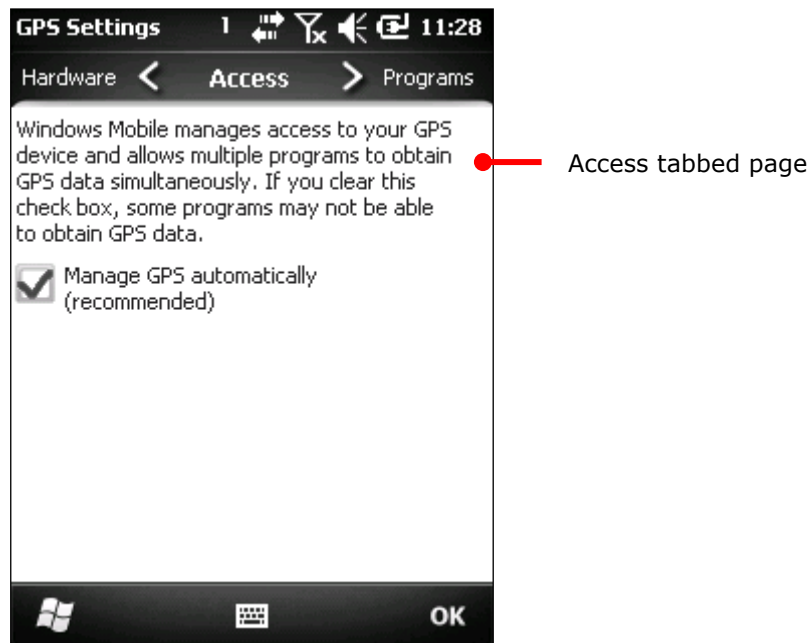

- 21) Make sure **Manage GPS automatically** is selected.
22) Run your GPS software or location-aware applications.

USE SECURE ACCESS MODULE

The mobile computer is enhanced with a Secure Access Module (hereinafter "SAM") to deliver payment-related applications by courtesy of a HF RFID reader integrated. SAM enables the authentication and encryption of the contact-less communication between the smart-card, the reader (mobile computer), and the backend host in a secure way.

The mobile computer needs a SIM-based SAM card plugged inside the SAM socket. SAM card stores the cryptographic keys needed to compute cryptograms.

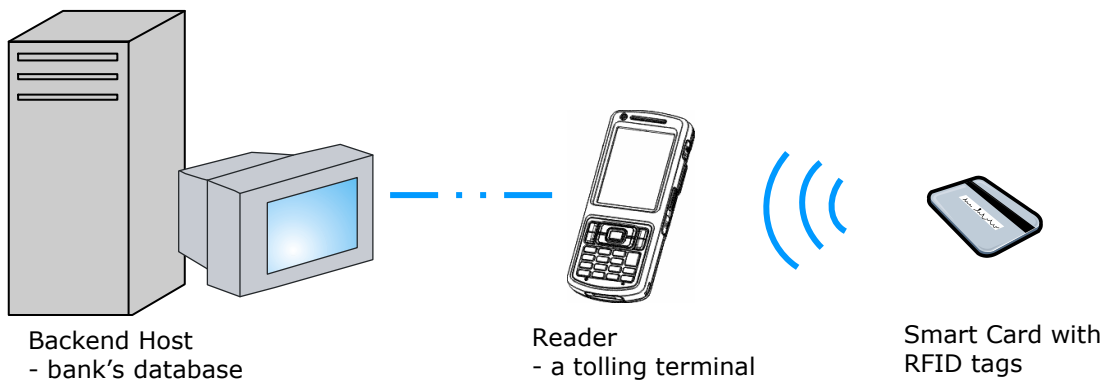

ASSEMBLE SAM CARD

Have a SAM card from your financial institute. Assemble it into the mobile computer following the steps below while referring to the illustration:

- 1) Power off the mobile computer. Remove the hand strap, battery door and main battery.
- 2) Find the SAM card socket inside battery chamber. (See also [Inside Battery Chamber.](#))
SAM card socket has a hinged cover.
- 3) Push back the hinged cover to unlock it.
- 4) Swivel up the hinged cover.
- 5) Position the SAM card as the signage below the socket illustrates . Fit the SAM card into place so the metal contacts on the SAM and on the PCB meet.
- 6) Put down the hinged cover.
- 7) Push-lock the hinged cover.
- 8) Restore battery, battery door, and hand strap.

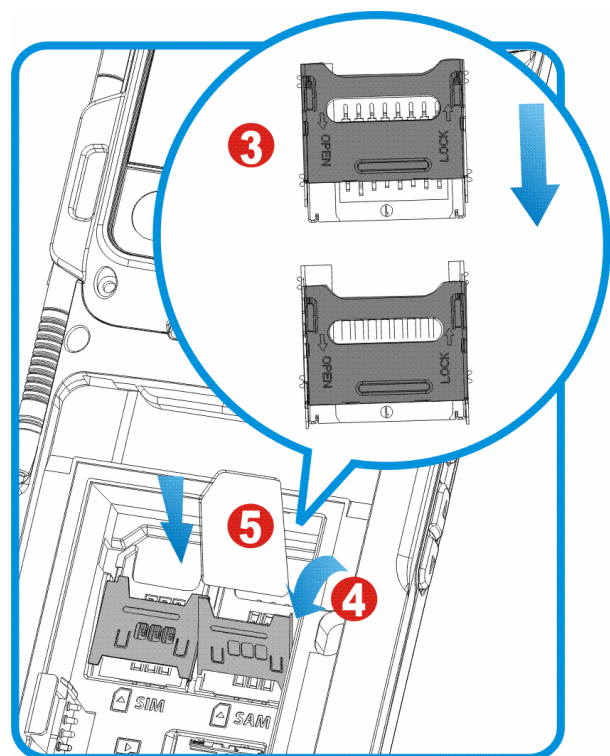

Figure 19: Inserting SAM Card

COLLECT PAYMENTS

To read a RFID tag for financial transaction:

- 1) Launch RFID reader module as described in [Launch Reader Module\(s\)](#).
Configure the reader if you want to. (See [Configure Reader\(s\)](#).)
- 2) Tap (slightly contact) the mobile computer's scanning window with the smart-card.
- 3) Press physical SCAN key (or either side trigger)

PHONE

With a SIM inserted, the mobile computer is capable of voice calls and data calls. By voice calls, you place and receive phone calls or text somebody on your contact list with the Phone application provided by the O.S.

This chapter guides to the phone's voice calls only. You will learn the basic features of the phone and some advanced functions such as using Bluetooth headset or answering another call during a call.

For the phone's data calls, see [Access Cellular WAN](#).

IN THIS CHAPTER

About Phone	162
SIM Card	162
Status Icons	163
Phone Ringtone & Vibrate	164
Place & End Calls.....	167
Answer or Decline Calls	175
Manage Call History	176
Call Contacts.....	179
Check Voicemails.....	180
Options during A Call	181
Make An Emergency Call	187

ABOUT PHONE

The mobile computer supports the following type of cellular technology for voice calls:

- ▶ GSM
- ▶ UMTS

SIM CARD

To use the mobile computer's phone, have a SIM card from your mobile carrier. Activate the SIM card and assemble it to the mobile computer. The phone is enabled by default and connects to your wireless network when the mobile computer powers on.

The mobile computer may ask you for a PIN to unlock the SIM card when it powers on by the support of the SIM card. Contact your mobile carrier for their default PIN. You can reset the PIN later on by the OS featured [Wireless Manager](#). See [Phone Settings](#).

ASSEMBLE SIM CARD

To assemble a SIM card, follow the steps below while referring to the illustration:

- 1) Power off the mobile computer. Remove the hand strap, battery door and main battery.
- 2) Find the SIM card socket in battery chamber. (See also [Inside Battery Chamber](#).) SIM card socket has a hinged cover.
- 3) Push back the hinged cover to unlock it.
- 4) Swivel up the hinged cover.
- 5) Position the SIM card as the signage below the socket illustrates . Fit the SIM card into place so the metal contacts on the SIM and on the PCB meet.
- 6) Put down the hinged cover.
- 7) Push-lock the hinged cover.
- 8) Restore battery, battery door, and hand strap.

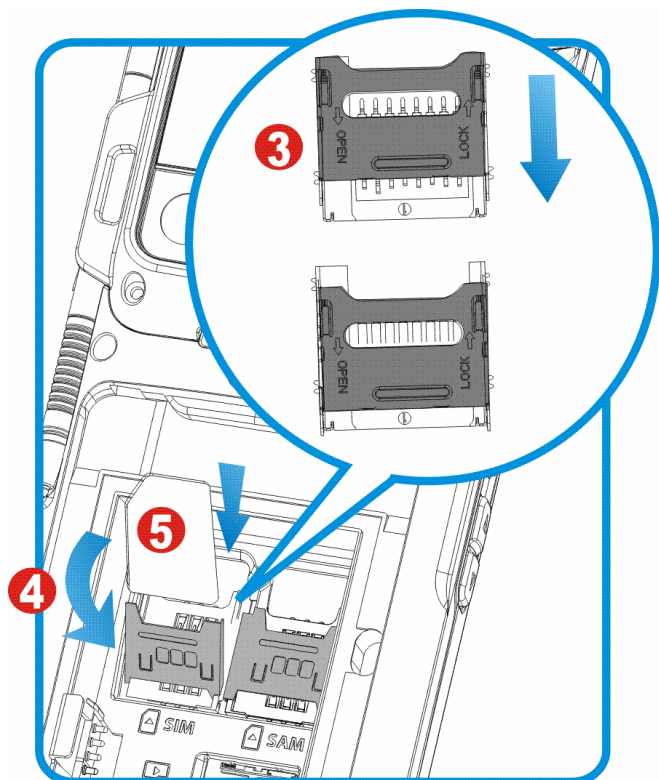







Figure 20: Inserting SIM Card

STATUS ICONS

Status icons for phone connection:

Status Icon	Description
	Phone off
	SIM card locked. PIN code required to turn on phone.
	Phone on with signal strength. The more bars are lit, the stronger the signal is.
	A call is being placed or a call is in progress
	Missed call(s)
	Connected to another mobile carrier's network (roaming)

PHONE RINGTONE & VIBRATE

Setting phone ringtone and phone vibrate for incoming calls relies on Sounds & Notifications



To access Sounds & Notifications:

- 1) Open Start screen, tap **Settings** | **Sounds & Notifications**.

Sounds & Notifications open showing Sounds tabbed page.

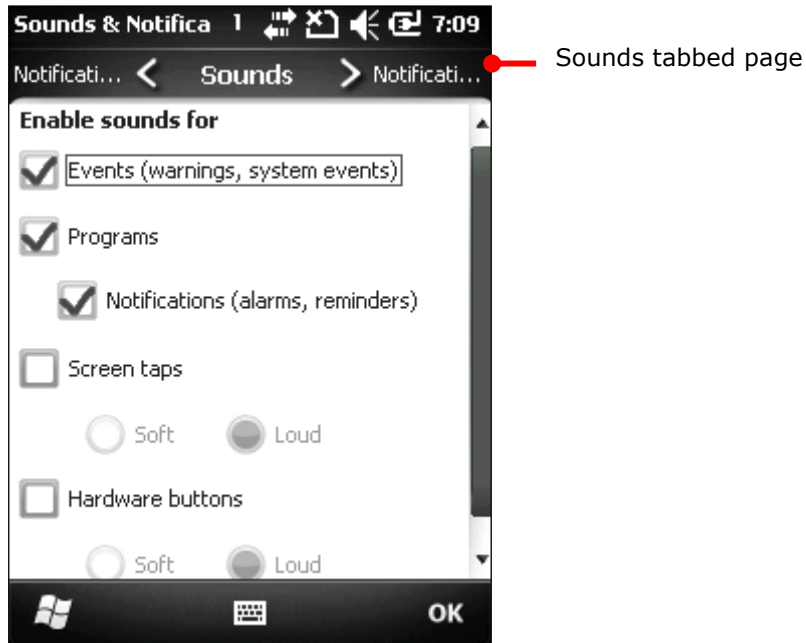

PHONE RINGTONE

To set phone ringtones:

- 1) Open Start screen, tap **Settings | Sounds & Notifications** .

Sounds & Notifications open showing Sounds tabbed page.

- 2) Tap **Notifications** tab.

Notifications tabbed page opens.

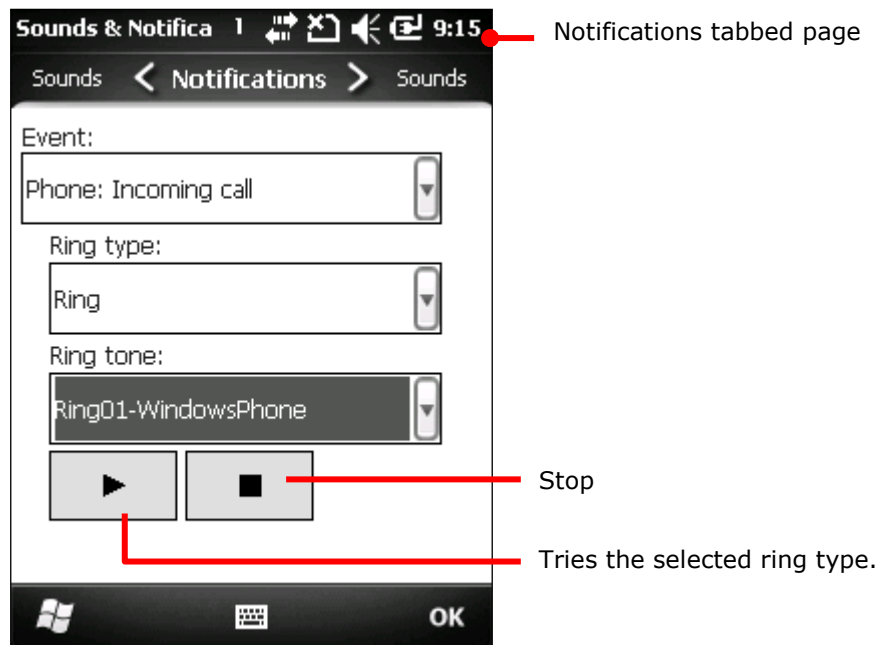

- 3) From **Event** drop-downs, select **Phone: Incoming call**.
- 4) From **Ring type** drop-downs, select **Ring** or other ringing types.
- 5) From **Ring tone** drop-downs, select the ring tone you prefer.
- 6) Tap the "OK" command on [Softkey bar](#) to apply change and quit settings.

UNIQUE PHONE RINGTONE SETUP

There are two approaches to set a song from your music collection for phone ringtone:

- 1) Copy the song to the mobile computer's directory **\My Documents\My Ringtones** using ActiveSync or mass storage.
- 2) Set the song to your phone ringtone as described in [Phone Ringtone](#).

OR

- 1) Copy the song to the mobile computer using ActiveSync or mass storage.
- 2) Browse for the song using File Explorer .
- 3) Tap & hold the song.
Context menu opens.

- 4) Tap **Set As Ringtone**.

The song is auto-copied to **\My Documents\My Ringtones** and set as your ring tone.

PHONE VIBRATE

To set phone vibrate:

- 1) On Start screen, tap **Settings | Sounds & Notifications**.

Sounds & Notifications opens showing Sounds tabbed page.

- 2) Tap **Notifications** tab.

Notifications tabbed page opens.

- 3) From **Event** drop-downs, select **Phone: Incoming call**.

- 4) From **Ring type** drop-downs, select **Vibrate** or other vibrate types.

- 5) Select a ringtone from **Ring tone** drop-downs if they become available.

- 6) Tap the "OK" command on [Softkey bar](#) to apply change and quit settings.

PHONE RINGER VOLUME

Phone ringer volume is only adjustable onscreen. See [Onscreen Volume Gauge](#).

PLACE & END CALLS

Use the OS featured Phone application to place calls, text somebody, or check voicemails. The Phone application enables setting up speed dials, managing contacts, and other sophisticated call applications.

OPEN PHONE

To open Phone application, there are two approaches:

Open Start screen. Tap Phone icon .

OR

Press the physical green Call key . (See also [Call key](#).)

Phone application opens showing the network currently connected to and recent calls, with dial pad opened.

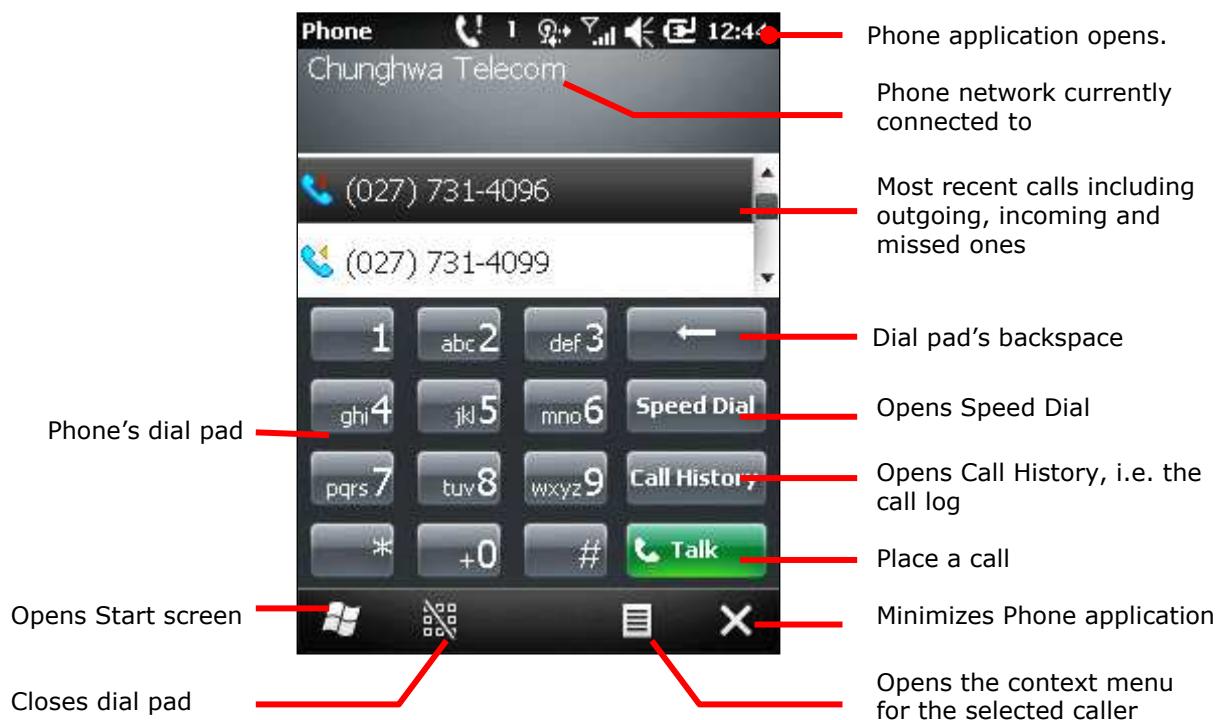



PLACE CALLS

The O.S. is rich in resources to place phone calls. Users are able to do it with Phone application, [Call History](#), [Speed Dial](#), or Call Contacts (the phone book). This section guides to two essential approaches featured by Phone application. For the others, hit the foregoing links.

To place a call:

- 1) Open Phone application as described in [Open Phone](#).
Phone application opens.
- 2) Tap the number to call on the dial pad.

In case entering a wrong number, tap backspace key  to withdraw the digit(s) one by one. Tap & hold the backspace key to erase the whole number.

To dial an international number, tap & hold 0 key  to enter plus (+) symbol. Then enter the international prefix for the country, followed by the full phone number.

- 3) Tap the green **Talk** key  on the dial pad.

The call is placed.

OR

- 1) Open Phone application as mentioned in [Open Phone](#).

Phone application opens.

- 2) From recent-calls list, tap the caller to call back.

A screen opens showing the caller's last call and providing the links to return call/text.

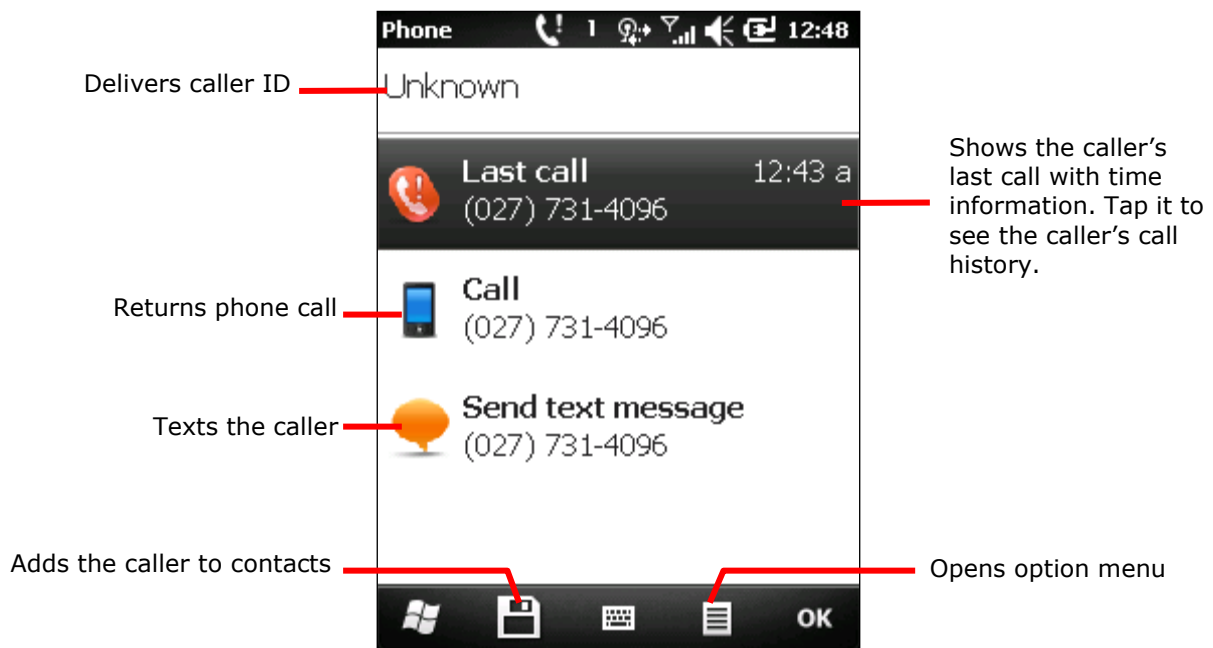

- 3) Tap the link that returns phone call.

As soon as the call is placed, the in-call screen opens. Once the call puts through, call duration displays onscreen.

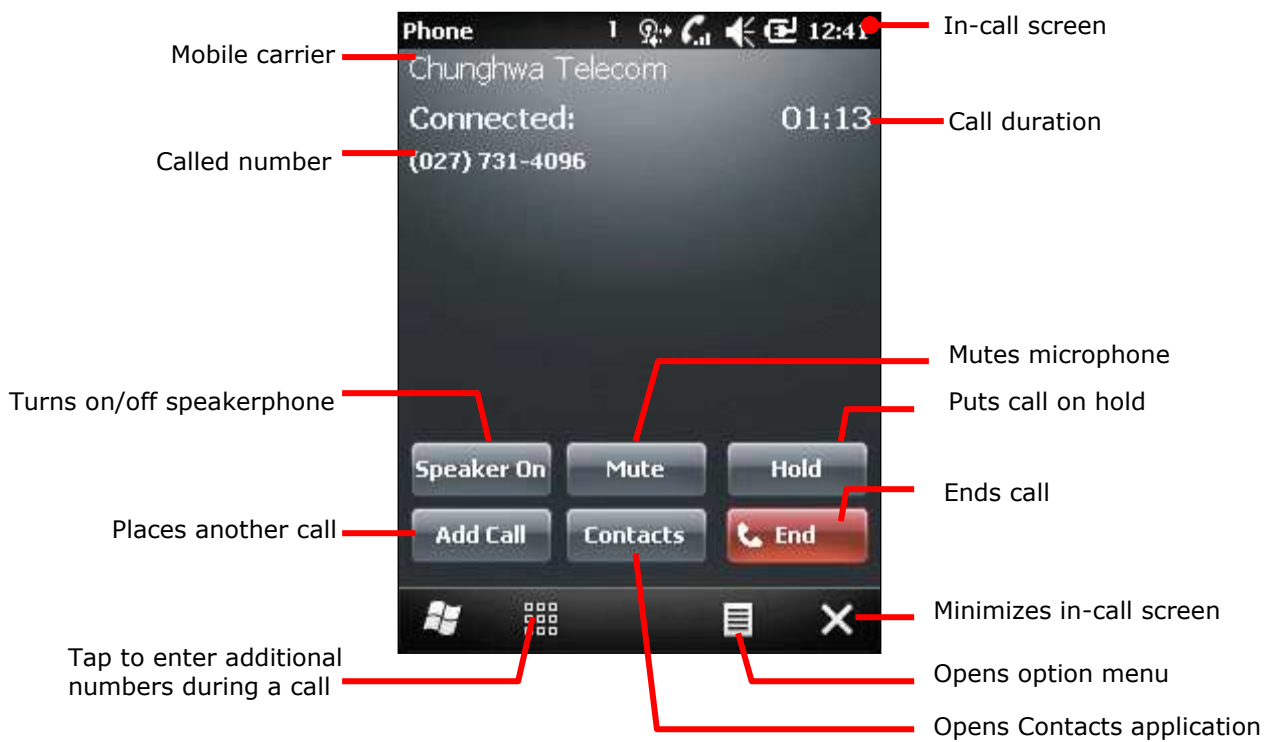

By closer observation, you would find the in-call screen is actually providing more actions for you to take during a call. See [Options during A Call](#) for more details.

MANAGE A CALLER

Manage a caller to customize phone ring type, ringtone and keypad tone for him/her.

1) When Phone application opens, tap the caller to manage.

2) Tap the "Menu" command  on [Softkey bar](#).

Option/context menu opens.

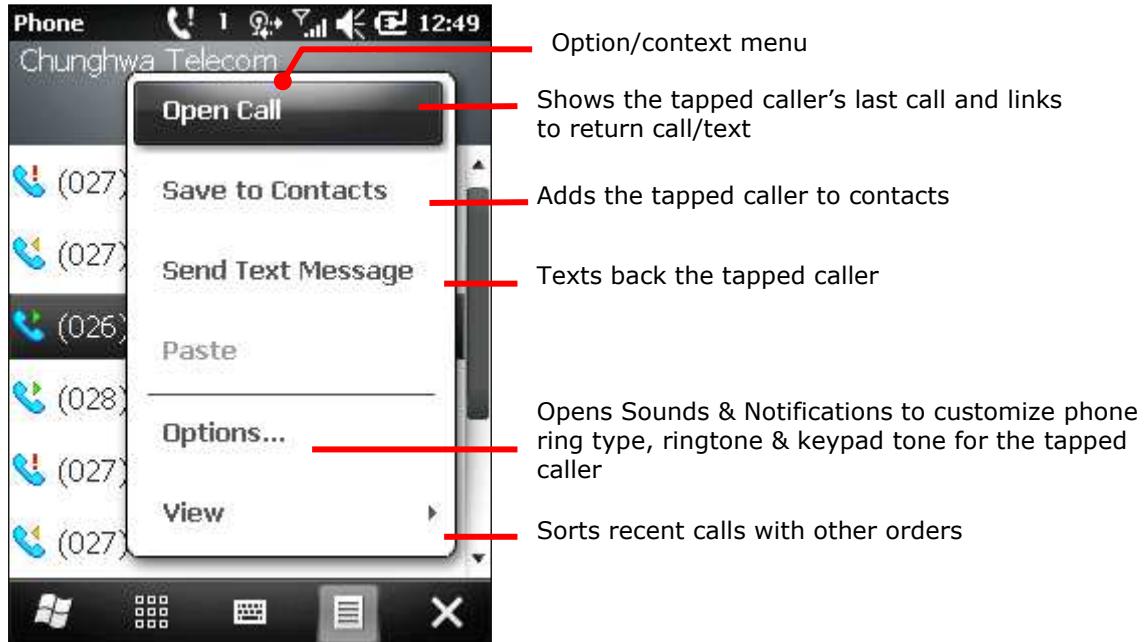

3) Tap **Options**.

Sounds & Notifications opens.

4) Customize phone ring type, ringtone and keypad tone for the caller.

See also [Sounds & Notifications](#).

CALL HISTORY

When Phone application opens, tap **Call History** button to open Call History where call log and accumulated call timers can be viewed. Call History also helps add a caller to contacts, delete call log entries, or text back a caller.

- 1) Open Phone application as described in [Open Phone](#).

Phone application opens.

- 2) Tap **Call History** button  on the dial pad.

Call History opens.

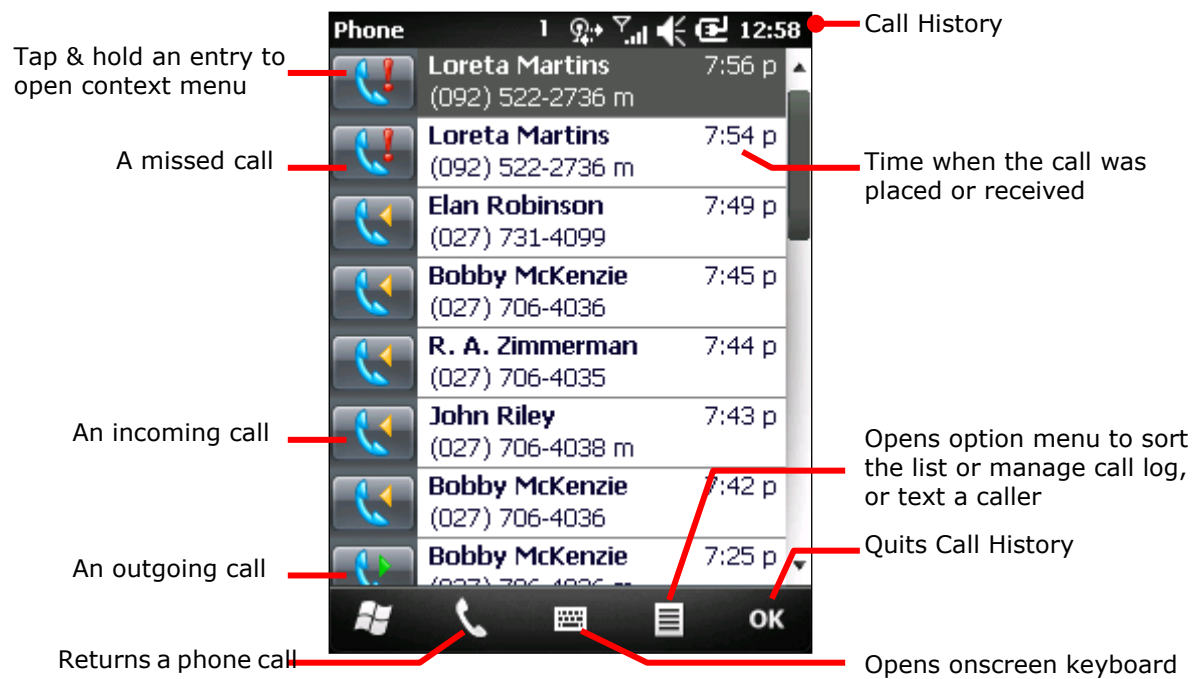

SPEED DIAL

“Speed Dial” enables users to place a call by pressing a reduced number of keys. It is very helpful to dial some regularly called contacts.

LAUNCH SPEED DIAL

To launch Speed Dial:

- 1) Open Phone application as described in [Open Phone](#).

Phone application opens.

- 2) Tap **Speed Dial** button  on dial pad.

Speed Dial opens:

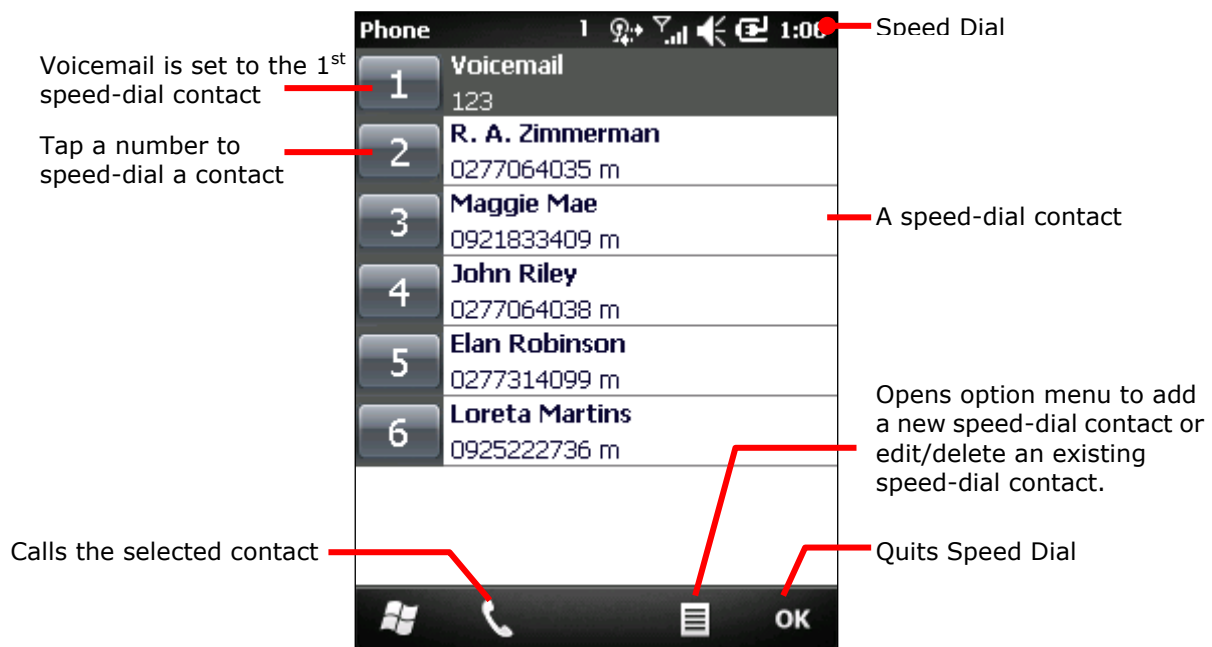

Note only contacts (in Contacts application) are addable to speed-dial contacts.

Note Speed Dial application sets your voicemail as the first speed-dial contact. Tap its numbering key to edit voicemail number. See **Voice mail & Text Messages** on page [222](#) to know how to set up voicemail.

SPEED-DIAL CONTACTS

To speed-dial a contact:

- 1) Open Phone application as described in [Open Phone](#).

Phone application opens.

- 2) From onscreen dial pad, tap & hold the number assigned to speed-dial a contact.

OR

From the physical keypad, press & hold the number assigned to speed-dial a contact.

Note to speed-dial a two-digit contact, tap/press the first digit and then tap/press & hold the second digit.

ADD SPEED-DIAL CONTACTS

To add a speed-dial contact:

- 1) Open Speed Dial application as described in [Launch Speed Dial](#).
Speed Dial opens.
- 2) Tap the "Menu" command  on [Softkey bar](#).
Option menu opens.
- 3) Tap **New**.
Contact application opens.
- 4) From the listed contacts, tap the contact to add.
- 5) Set a screen name, enter phone number and assign the numbering for the contact.
Numbering 2 through 99 are configurable.
- 6) Tap the "OK" command on Softkey bar to apply change and quit setting.

BACK TO PHONE APPLICATION

There are cases when you navigate to other applications during a call. To return to in-call screen to end a call or do something else, you need to:

- 1) Press the physical home button .
Today screen opens.
- 2) Tap the "**Call St...**" command on [Softkey bar](#) which suggests there's a call ongoing.
In-call screen opens.

DISABLE PHONE CALLS

There are occasions requiring you to turn off the mobile computer' radios such as on an airplane. To disable phone:

- 1) On Start screen, tap **Settings | Connections | Wireless Manager** .

Wireless Manager opens.

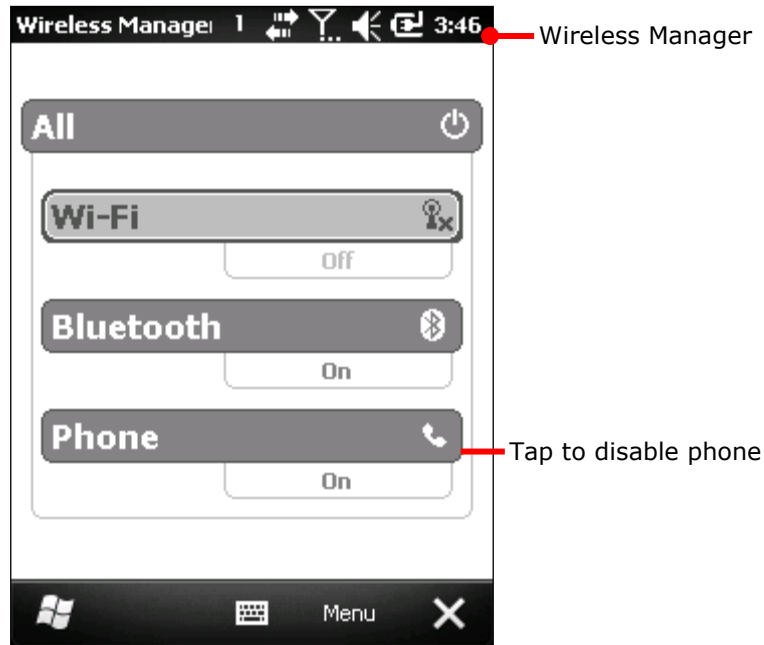



- 2) Tap **Phone** entry to enable/disable phone.



Note when phone is turned off, mobile data is off as well.

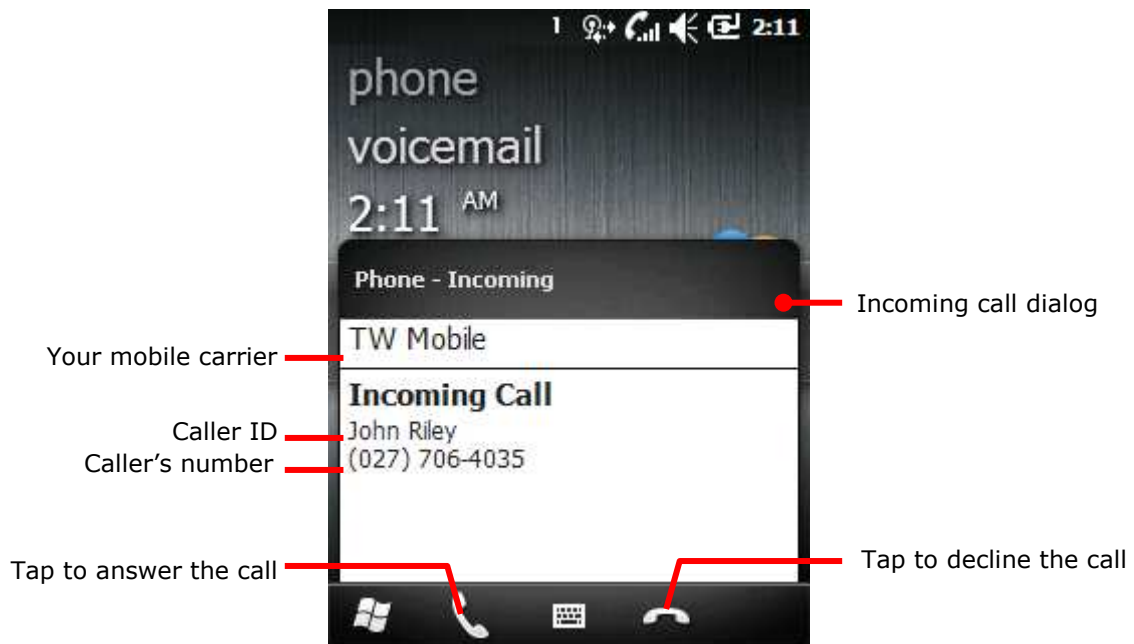

Tapping **All** will enable/disable all Bluetooth, Wi-Fi, and phone.

ANSWER OR DECLINE CALLS

When you receive a phone call, the incoming call dialog opens showing caller ID and other info about the caller you have entered in Contacts application. (See [Call Contacts](#).) The incoming call screen shows each answer icon  and decline icon  to pick up or drop the call.



All incoming calls are recorded in [Call History](#). If a call is missed, you receive a missed call notification  on Title bar, and an  icon on Drop-down bar.

- ▶ To answer a phone call, tap answer icon  on [Softkey bar](#).
- ▶ To decline a call, tap decline icon  on [Softkey bar](#). The caller is diverted to your voicemail to leave a message.

MANAGE CALL HISTORY

Call History shows a list of the calls you have placed, received, and missed. Call History makes it quick and easy to redial a number, return a phone call, or add a contact.

OPEN CALL HISTORY

To open Call History:

- 1) Open Phone application as described in [Open Phone](#).

Phone application opens showing the most recent callers and a dial pad.

- 2) Tap **Call History** button  on the dial pad.

Call History opens.

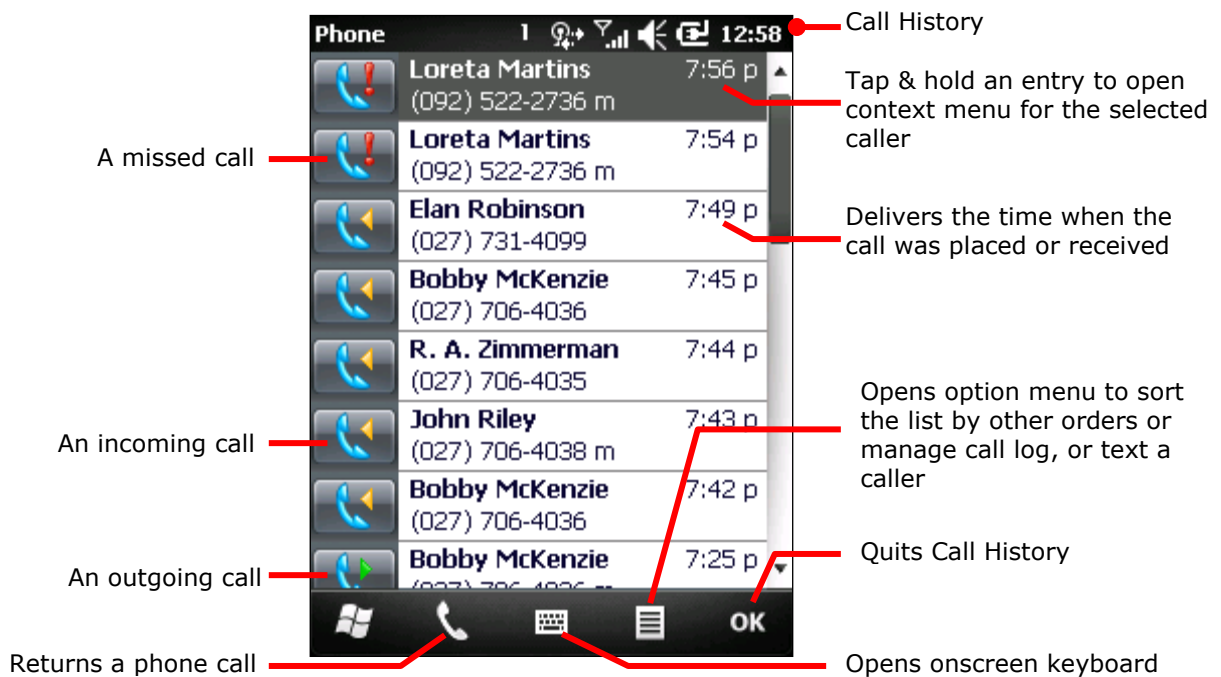

Most recent calls are listed atop others. Scroll down to view earlier calls in the log.

See also [Call History](#).

ADD A CALLER TO CONTACTS

To add a caller from Call History to Contacts:

- 1) Open Call History as described in [Open Call History](#).

- 2) Tap & hold a caller to add.

Context menu opens.

- 3) Tap **Save to Contacts**.

Contacts application opens.

- 4) Tap **<New Contact>**.

You are prompted to select a contact type.

- 5) Select a contact type.
- 6) Follow onscreen instructions to proceed.

VIEW CALLER SCREEN

Tap a call log entry on Call History to open a screen detailing it, including the date and time the call came about. Whether the caller is an existing contact or an unidentified one, "caller screen" features the link to return calls or remove one or more call log(s) from a caller/contact.

- 1) Open **Call History** as described in [Open Call History](#).

Call History opens.

- 2) Tap the call log incurred by the caller to view.

A caller screen opens. If it is an existing contact in Contacts (the phone book), the caller screen additionally shows contact ID and avatar.

- 3) Tap a link to call back.

OR

Tap the "Menu" command  on [Softkey bar](#) to remove one or more call log(s) from a caller/contact

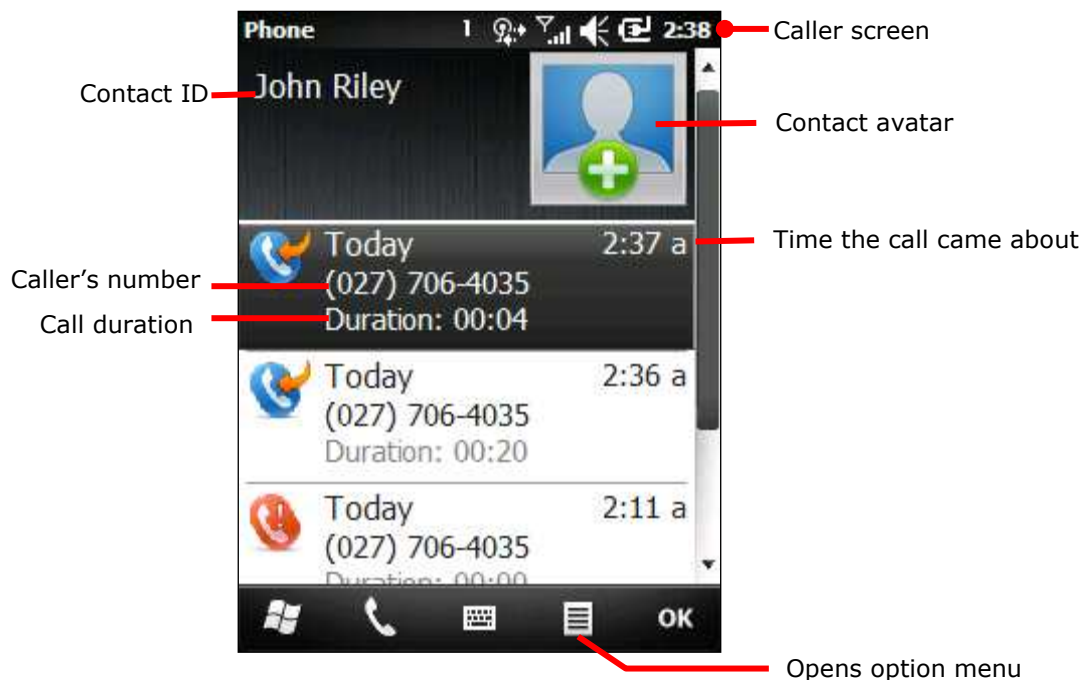

TAKE OTHER ACTIONS TO A CALL LOG ENTRY

Tap & hold a call log entry on Call History to take some actions to a call log.

- 1) Open **Call History** as described in [Open Call History](#).
Call History opens.
- 2) Tap the call log to take actions for.
Context menu opens.
- 3) Save the caller to a contact, view the note(s) taken for the caller, delete the call log, text or call the caller back.

CLEAR CALL HISTORY

To erase the whole call log on the mobile computer:

- 1) Open Call History as described in [Open Call History](#).
Call History opens.
- 2) Tap the "Menu" command  on [Softkey bar](#).
Option menu opens.
- 3) Tap **Delete All Calls**.
You are prompted to confirm permanent deletion.
- 4) Tap **Yes**.
Call log is erased from the mobile computer.

To delete a single call log entry, tap & hold the call log entry to delete. Then tap **Delete** from the context menu that opens.

CALL CONTACTS

Contacts application is sort of the mobile computer's phone book. It tracks contacts in your call log, emails, instant messenger and so on. Besides it also places phone calls for you.

LAUNCH CONTACTS

To launch Contacts application:

- 1) On Start screen, tap the shortcut to Contacts application .

Contacts application opens listing the contacts recently got in touch with through phone, email or instant messengers.

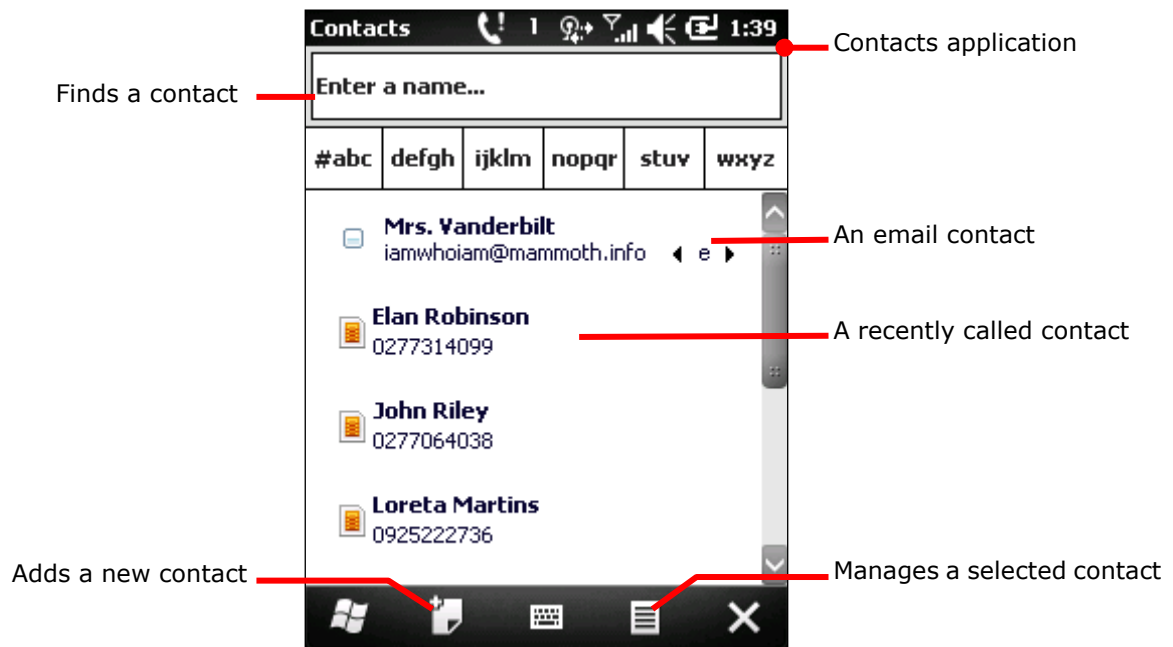

- 2) Tap the contact to call.
The contact's screen opens.
- 3) Tap a number you use to call him/her.
- 4) See [Take Other Actions to A Call Log](#) for follow-ups.

To find a contact, enter the contact's name in the top field.

TAKE OTHER ACTIONS TO A CONTACT ENTRY

- 1) Open Contact application as mentioned in [Launch Contacts](#).
Contacts application opens.
- 2) Tap & hold a contact.
Context menu opens.
- 3) Call, email or text a contact, add the contact to other contact types, edit contact info, or delete the contact.

CHECK VOICEMAILS

When a new voicemail comes in, the O.S. sends a notification  to you on Title bar for a missed call. Some mobile services send text messages to notice users of voicemail.

To check voicemails:

- 1) Tap Title bar to open Drop-down bar.

Drop-down bar opens presenting a sequence of icons.

- 2) Tap **Text** icon .

Text application opens.

- 3) Tap the active text message.

The text message opens providing the link to dial-up your voicemail box.

OR

- 1) Open Speed Dial as described in [Speed Dial](#).

- 2) Tap the number of voicemail box.

See [Speed Dial](#) for more details about Speed Dial application.

OR

- 1) Open Phone application as mentioned in [Open Phone](#).

- 2) On dial pad, tap the number of your voicemail box.

- 3) Place the call.

OPTIONS DURING A CALL

When you are on a call, whether an incoming or outgoing one, you can take a sequence of actions to that call. You can put the call on hold, create a phone conference, mute microphone, and others.

As soon as a call is placed, in-call screen opens. When it puts through, call duration counts up.

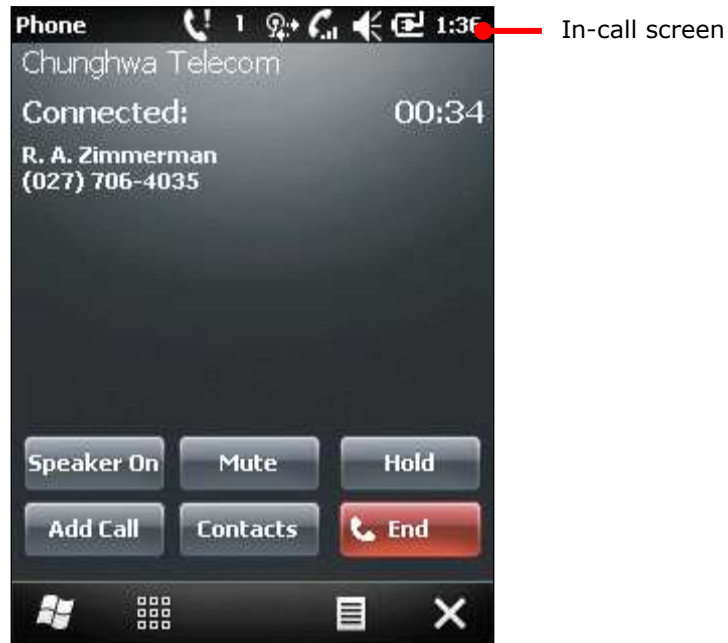

ADJUST IN-CALL VOLUME

Note in-call volume is only adjustable when a call is ongoing. To adjust in-call volume, there are two approaches:

BY PHYSICAL VOLUME ROCKER

- 1) (Continuously) Press the physical volume rocker. In-call volume is decreased or increased. Once physical volume rocker is pressed, the onscreen gauge opens. Adjust onscreen.

Onscreen in-call volume gauge

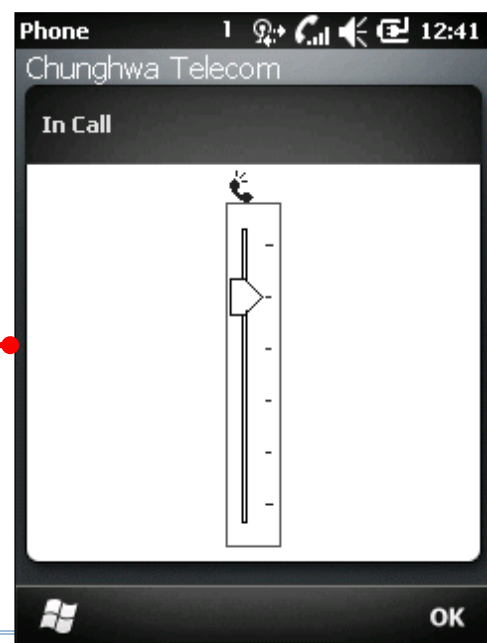



BY ONSCREEN VOLUME GAUGE

- 1) On in-call screen, tap Title bar.
Drop-down bar opens.
- 2) Tap volume icon .
In-call volume gauge opens.
- 3) Move the slider up and down the gauge.
In-call volume is decreased or increased.

PUT A CALL ON/OFF HOLD

To put a call on/off hold:

- 1) Tap **Hold** button  on in-call screen.



The call is put on hold. On in-call screen **Hold** button changes to **Unhold** . An unhold icon  comes up on Title bar to remind you have a call on hold.

- 2) Tap **Unhold** button to resume the call.

MUTE/UNMUTE MICROPHONE

To mute/unmute microphone during a call:

- 1) Tap **Mute** button  on in-call screen.

Microphone is muted. On in-call screen, **Mute** button changes to **Unmute** . An unmute icon  shows in the upper right corner onscreen to remind you microphone is off.



- 2) Tap **Unmute** button to turn back on microphone.

Note microphone is auto back on when the call ends.

TURN ON/OFF SPEAKERPHONE

To turn on/off speakerphone during a call:

- 1) Tap **Speaker On** button  on in-call screen.

Speakerphone is turned on. On in-call screen, **Speaker On** button changes to a **Speaker Off** , and a speaker-on icon  comes up on Title bar to remind you speakerphone is off.

- 2) Tap **Speaker Off** button to turn off speakerphone.



ADD A CALL

To place another call during an ongoing call:

On in-call screen, tap **Add Call** button .

OTHER OPTIONS

There are other actions to take during a call by tapping the commands on Softkey bar of in-call screen:



- ▶ Tap dial pad icon  to open dial pad in case you need to enter additional numbers during a call.
- ▶ Tap the "Menu" command  to open option menu to take the following actions:
 - Putting the call on hold. (See [Put A Call on/off Hold.](#))
 - Muting the call. (See [Mute/Unmute Microphone.](#))
 - Swapping between callers. (See [Switch between Two Callers.](#))
 - Creating conference calls. (See [Manage Multiple Calls](#))
 - Turning on speakerphone or hands-free kit. (See [Turn on/off Speakerphone](#))
 - Opening Call History and Speed Dial in case you need to add a call. (See [Manage Call History & Call Contacts.](#))
 - Opening Notes application to take down notes.
 - Customize ring type, ringtone, keypad tone for the caller. (See [Manage A Caller.](#))
 - Viewing contact details.

MANAGE MULTIPLE CALLS

When you are on a call, you are able to place another call, answer another call that comes in, switch between two or more callers, or combine two calls into one conference call.

ENABLE MULTIPLE CALLS

To be able to pick up another call during a call, make the following setting:

- 1) On Start screen, tap **Settings | Connections | Wireless Manager**  .
Wireless Manager opens.
- 2) Tap the "Menu" command  on [Softkey bar](#).
Option menu opens.
- 3) Tap **Phone Settings**.
Phone settings open.
- 4) Continuously tap on the tabs to bring the **Service** tab into view.
- 5) Tap **Service** tab.

Service tabbed page opens.

- 6) Select **Call Waiting**, and tap **Get Settings...** button.

The O.S. proceeds to fetch your call setting from the phone network. Once fetched, a **Phone: Call Waiting** page opens.

- 7) Tap **Notify me**.

- 8) Tap the "OK" command on [Softkey bar](#) to apply change and quit setting.

So when another call comes in during a call, you are noticed by an audible sound and an onscreen dialog showing caller ID and other info which is analogous to a conventional one. (See [Call Contacts](#))

Tap answer icon  to pick up the second call. The first call is automatically put on hold.



Note you are allowed to swap between two callers at the most. For the third call comes in, the O.S. prompts "**Answering the incoming call will disconnect your active call**".

SWITCH BETWEEN TWO CALLERS

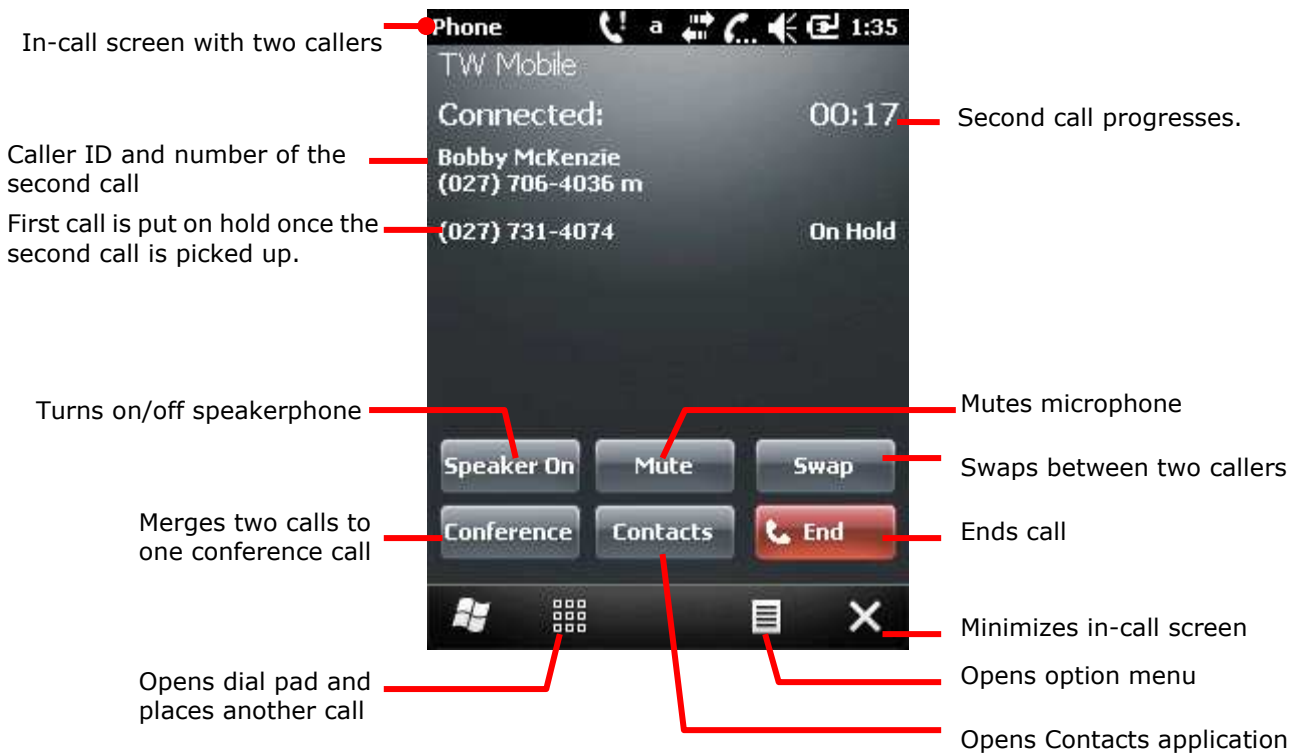

Upon picking up the second call, the first call is put on hold, and in-call screen shows the second call info.



To switch between two callers:

- 1) Tap **Swap** button  on in-call screen.
Phone switches to the caller on hold.

SWITCH BETWEEN BLUETOOTH HEADSET AND SPEAKERPHONE

When the mobile computer is using a Bluetooth headset, an  icon comes up on Title bar, and a bigger  icon shows on Drop-down bar when it opens.

When a call comes in, the notice dialog shows an additional graphic of hands-free  in the upper right.

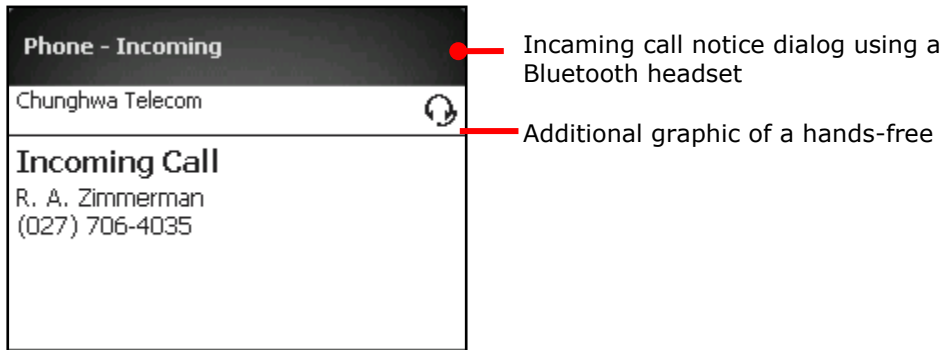

And all the incoming, outgoing and in-call screens show an additional graphic of hands-free  at the upper right.

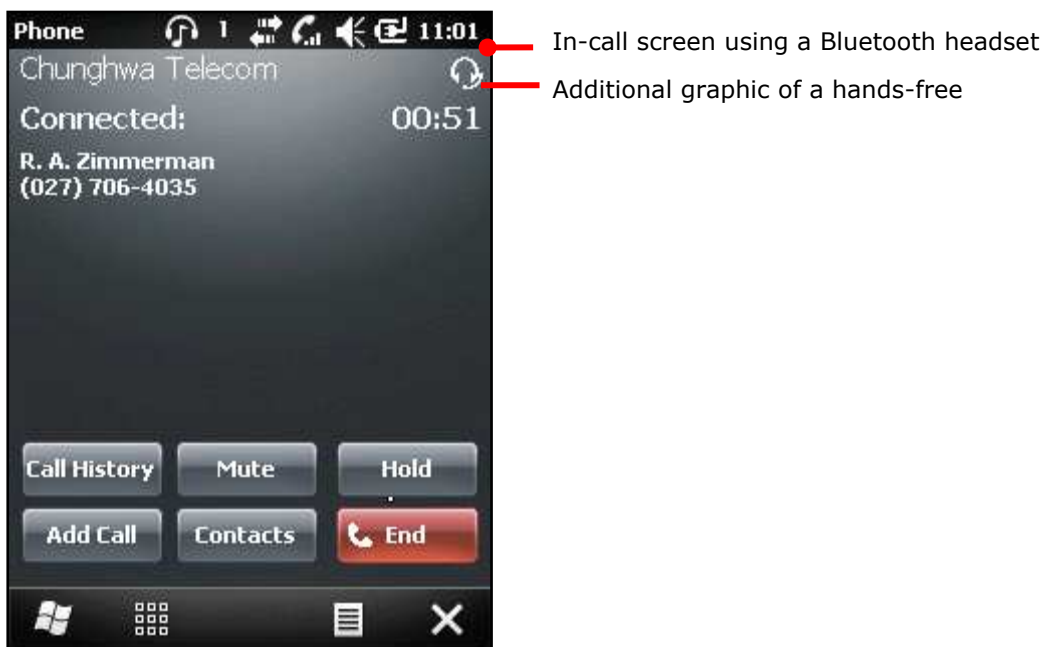

You can conduct all calls on the headset for hands-free conversation, such as placing, ending, answering or declining a call, redialing a number, answering a second call, or switching between two callers. See the manual or documentation of your Bluetooth hands-free for details.

During a call, tap the "Menu" command  and tap **Turn on/off Hands-free** to switch between the hands-free and speakerphone.

Notes for using Bluetooth hands-free:

- ▶ When you pick up the phone with your hands-free, the hands-free is auto on for your phone conversation. However,...
- ▶ ... When you pick up a call on the mobile computer, you need to turn on the hands-free by tapping the "Menu" command  on [Softkey bar](#) and tap **Turn on Hands-free** to use the hands-free for phone conversation.

For details about using Bluetooth peripherals with the mobile computer, see [Use Bluetooth](#).

MAKE AN EMERGENCY CALL

When no SIM card is installed or you don't have the PIN to unlock it, the mobile computer shows a SIM card missing icon  on Title bar. In this case, you are still able to call your local emergency services by dialing the emergency phone number.

MORE APPLICATIONS

Save for the dedicated *ReaderConfigMobile.exe* to the mobile computer's specialty in data capture as mentioned in [Data Capture](#), more manufacturer-developed applications are preinstalled to strengthen user's system management and make the mobile computer more eligible.

A group of said applications are accessible under Start screen | **CipherLabUtilities**. This chapter will comb through the details about them.

An encapsulation of these applications:

Applications	Description
Backup Utility	Reserves and restores system registry and system files.
Button Assignment	Assigns new functions to some physical keys.
GPS Viewer	Discovers locations.
Signature Utility	Captures, views, edits signatures.

IN THIS CHAPTER

Backup Utility.....	190
Button Assignment	199
GPS Viewer.....	202
Signature Utility	205

BACKUP UTILITY

With the name saying backup, CipherLab's Backup Utility actually does backup and restoration, a process of copying files and putting them back to system. They are very important for a computer or database once it is rendered unusable by any software or hardware error.

Backup Utility facilitates backing up important files from time to time to save it for rainy days.

Features:

- ▶ Reserves and restores system registry and system files.
- ▶ Flexible file selection.
- ▶ Easy cloning with effortless file(s) backup.

LAUNCH BACKUP UTILITY

To launch Backup Utility:

- 1) On Start screen, tap **CipherLabUtilities**  .
CipherLabUtilities opens.

- 2) Tap Backup Utility  .

Backup Utility opens showing **Registry** tabbed page while hiding **Backup**, **Restore**, and **About** tabbed pages.

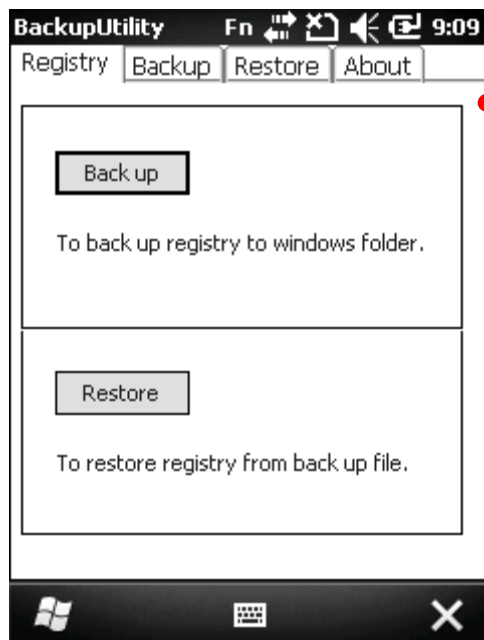

Backup Utility opens.

The four tabbed pages are summarized as follows:

Tabbed Page	Description
Registry	<ul style="list-style-type: none"> ▶ Backs up system registry. ▶ Recovers system registry.
Backup	Makes duplicate copy of system files.
Restore	Recovers system files.
About	Delivers software version and developer info.

REGISTRY BACKUP AND RESTORATION

“Registry” is a database of the information about system configuration and application settings that form the basis of operating system.

The following guides to back up and restore system registry.

REGISTRY BACKUP

Registry backup reserves the system configuration and application settings at a checkpoint when the condition is stable, which can come to rescue when system becomes conflicting and erroneous.

To back up Registry:

- 1) Launch Backup Utility as described in [Launch Backup Utility](#).

Backup Utility opens showing **Registry** tabbed page.

- 2) Tap **Back up** button.

A dialog pops up prompting you to close all processes before backup.

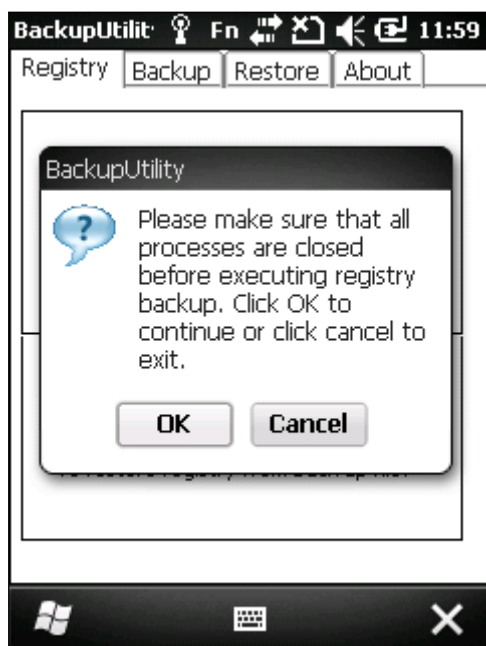

- 3) Tap **OK** to proceed, or tap **Cancel** if you haven't closed all processes.

Use the OS featured [Task Manager](#)  to monitor cached processes and close opened applications.

Upon **OK** being tapped, backup replication starts and finishes in a fraction of second. Then a dialog pops up to notice of finish.



- 4) Tap the upper-right **ok**.

The dialog closes. Two registry backup files are incurred under **My Device\Windows**.

REGISTRY RESTORATION

Registry restoration brings system configuration and application settings back to an earlier checkpoint when the condition is stable.

To restore Registry:

- 1) Launch Backup Utility as described in [Launch Backup Utility](#).

Backup Utility opens showing **Registry** tabbed page.

- 2) Back up Registry as described in [Registry Backup](#) if you haven't.

- 3) Tap **Restore** button.

A dialog pops up prompting you to close all processes before enacting restoration.

Use the OS featured [Task Manager](#)  to monitor cached processes and close opened applications.

- 4) Tap **OK** to proceed, or tap **Cancel** if you haven't closed all processes.

Upon **OK** being tapped, restoration starts and finishes in a fraction of second. Then a dialog pops up to notice of finish and prompts warm boot.

- 5) Soft-reset the mobile computer as described in [Warm Boot \(Soft Reset\)](#).

System configuration and application settings are restored to an earlier stable condition.

SYSTEM FILES BACKUP

Backing up system files relies on **Backup** tabbed page.

To back up system file(s):

- 1) Launch Backup Utility as described in [Launch Backup Utility](#).

Backup Utility opens showing **Registry** tabbed page.

- 2) Tap **Backup** tab.

Backup tabbed page opens searching and importing system items from directory **\My Device**



In a few minutes, the search is through. The utility shows the discovered file system overlaid by a dialog noticing that all applications should be closed before backup.

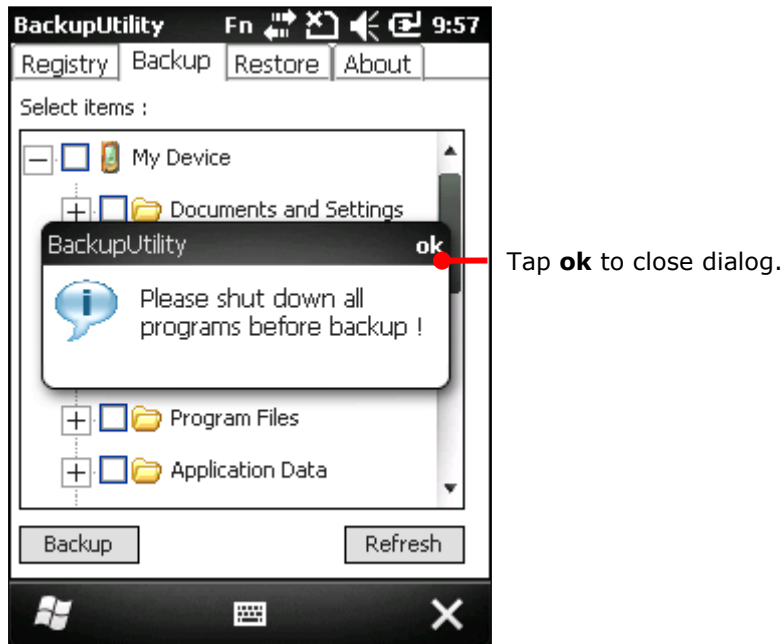

Use the OS featured [Task Manager](#)  to close opened applications.

- 3) Tap the upper-right **ok**.

The dialog closes, and the file system reveals itself as a tree-like structure in hierarchical order. Each plus sign (+) is a node to expand an item or sub-item. And each item comes with a check box for selection and deselection.

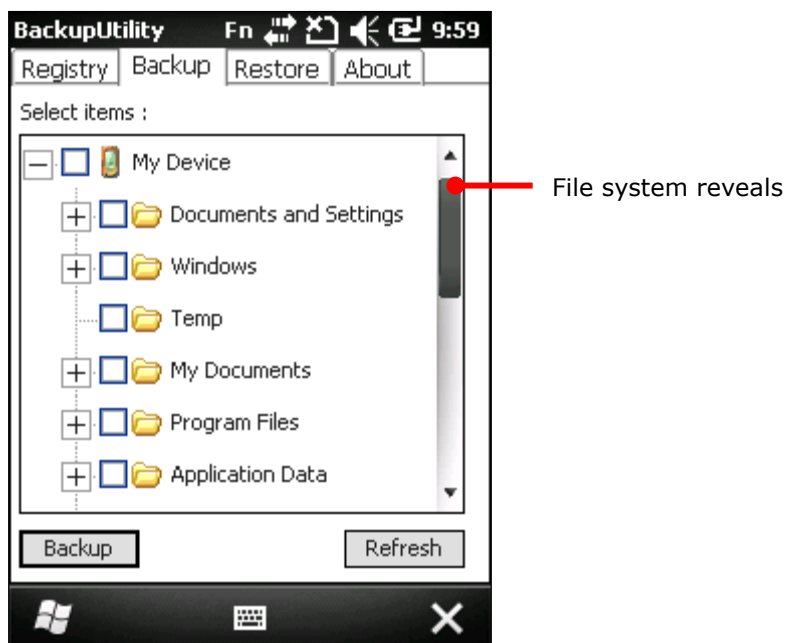

- 4) Select the item(s) to back up. Deselect the item(s) not to back up.

- 5) Done with selection and deselection, tap the lower-left **Backup** button.
 A **Save As** screen opens.

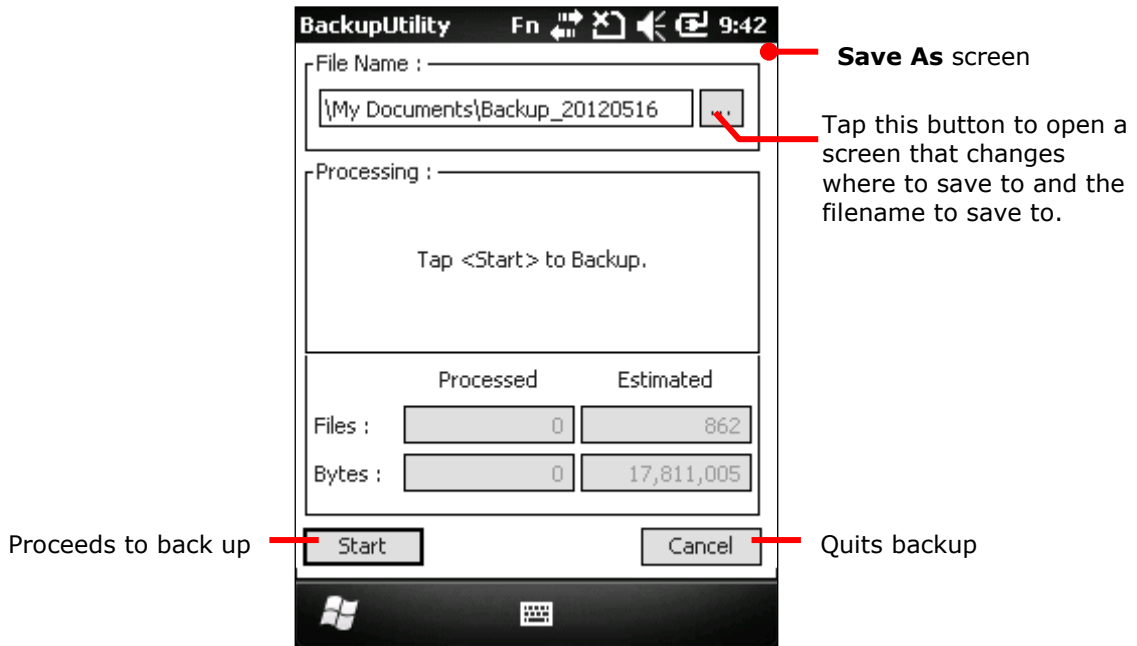

By default, backup file is saved to **\My Device\My Documents** with an auto-assigned filename and file extension (*.bkp). To change the defaults, tap the ellipsis (...) button attached to **File Name** setting.

- 6) Tap **Start** to proceed.

The utility proceeds to generate prospective backup file. Once the generation is through, the utility shows a result screen, and a backup file of .bkp format is incurred in the assigned folder.

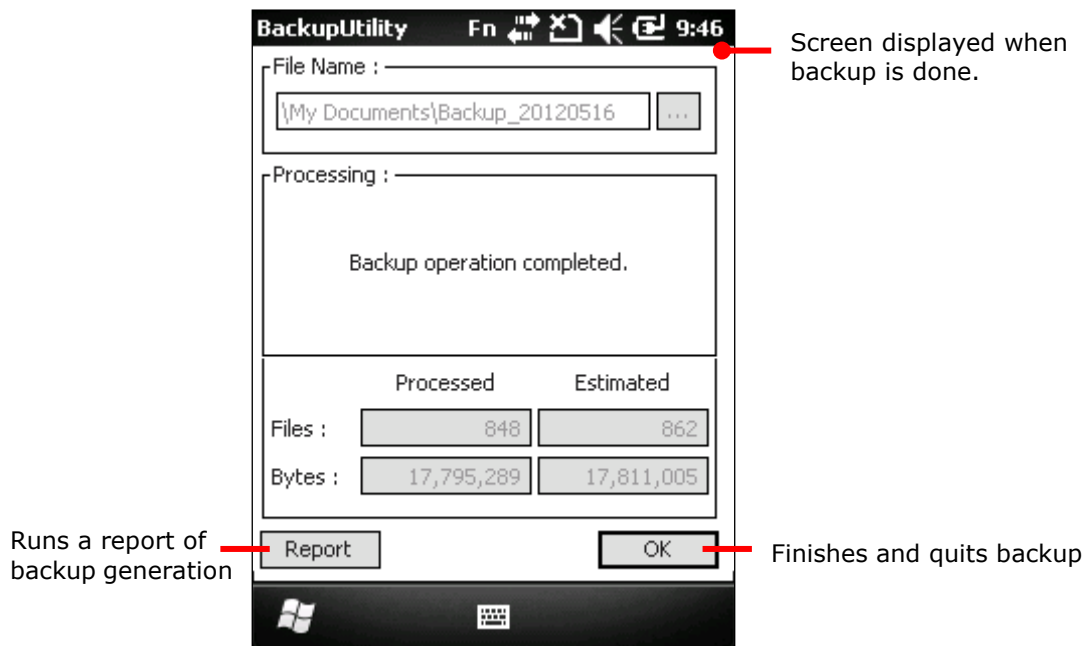

- 7) Tap **OK** to finish and quit backup, or tap **Report** to view the details of the generation.

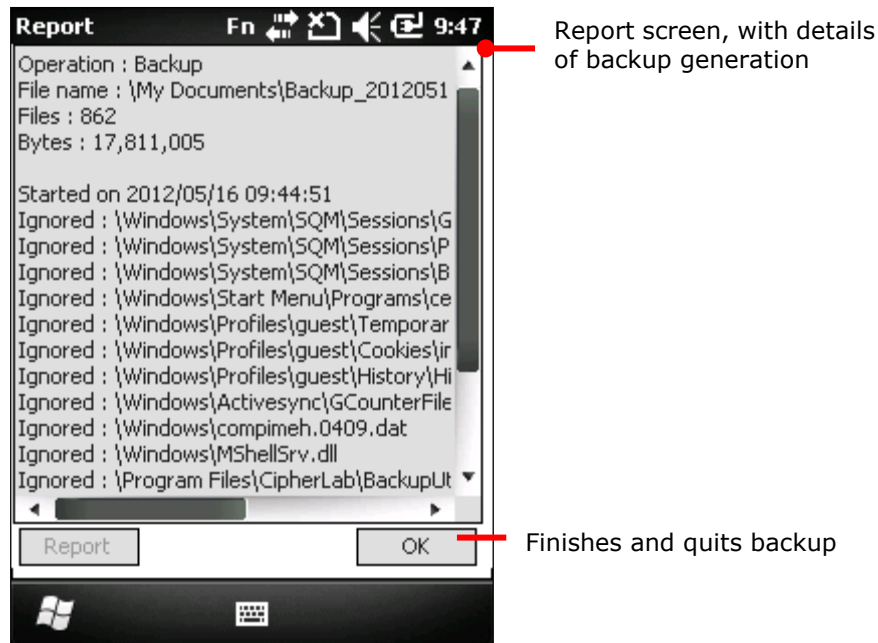

A backup file with .bkp format is generated under **\My Device\My Documents** for necessary restoration in case of emergency.

SYSTEM FILES RESTORATION

For system file(s), as long as any backup is found on the storage, whether internal or external, restoration is available. Restoration of system files relies on **Restore** tabbed page.

To restore system file(s):

- 1) Launch Backup Utility as described in [Launch Backup Utility](#).
Backup Utility launches showing **Registry** tabbed page.
- 2) Generate backup file(s) as described in [System Files Backup](#) if you haven't.
Skip this step if you have already.

- 3) Tap **Restore** tab.

Restore tabbed page opens searching for available backup file(s) on the mobile computer. (If auto-searching doesn't start, tap the bottom-right **Refresh** button.) Once search is through, it shows the found in **Available backup files** box.

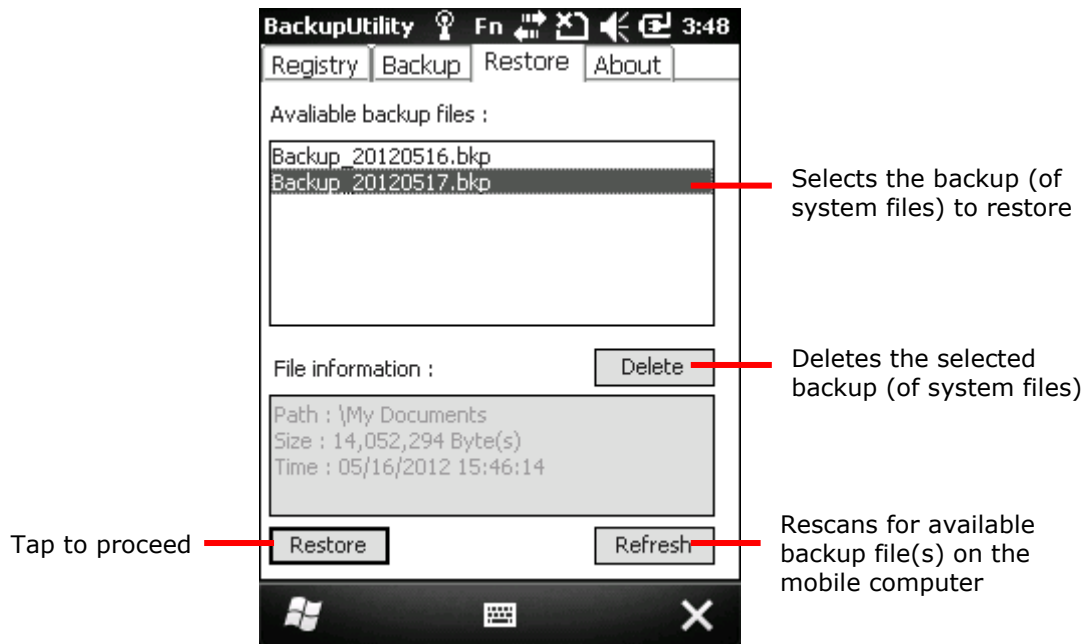

- 4) Tap the bottom-left **Restore** button.

A screen opens showing estimation of required storage.

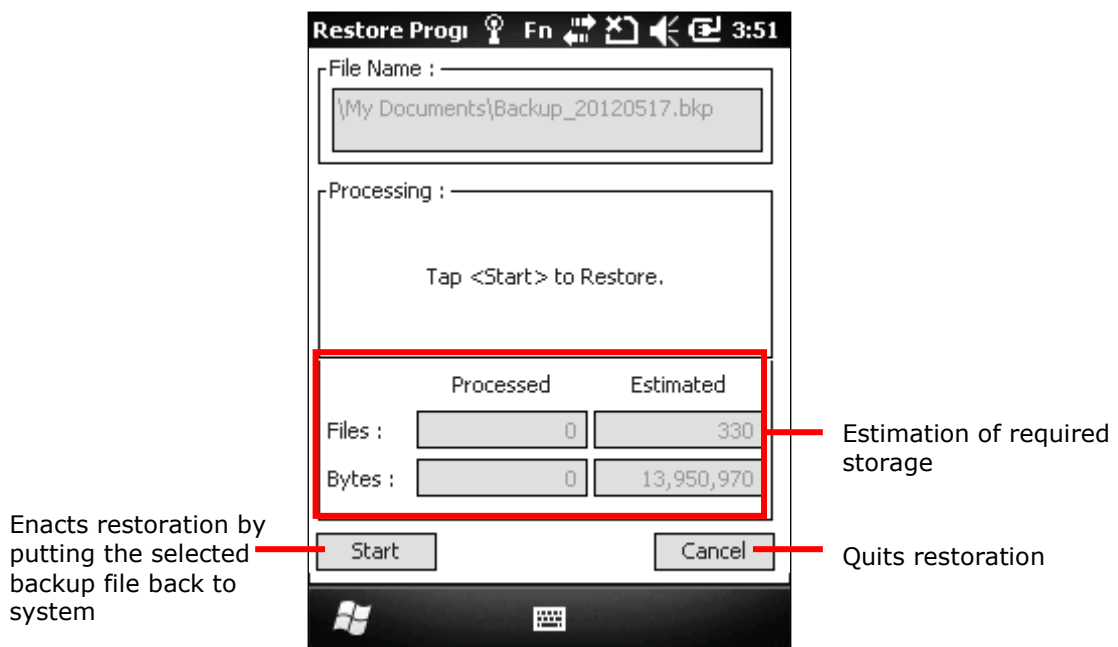

- 5) Tap the bottom-left **Start** button.

Restoration starts, proceeds and finishes in a few minutes. The selected backup (system file(s)) is put back to system.

- 6) Restart operating system to apply the change.

CLONE

A "clone" is a computer that behaves in the same way as the original (master) it was copied from. To be a clone, a computer has to have all the master's system files and system registry, which Backup Utility is capable of as previously mentioned in [System Files Backup](#).

To clone a mobile computer:

- 1) Back up system registry as described in [Registry Backup](#) if you haven't.

A few backup files for system registry are incurred under **\My Device\Windows**.

- 2) Open **Backup** tabbed page.

Backup tabbed page opens. The tree-like system structure shown should display two sub-items **Machine Registry** and **User Registry** right under **My Device**.

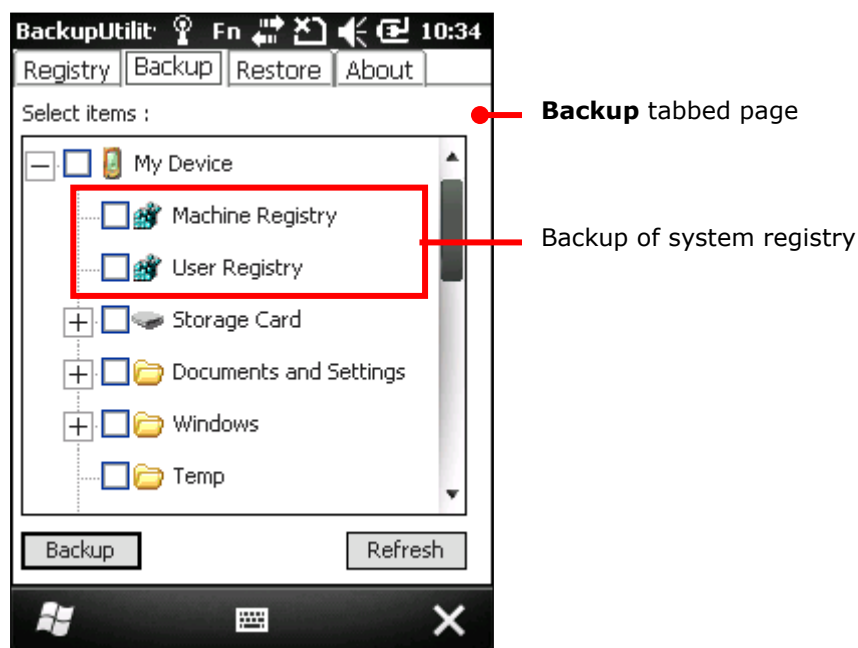

- 3) Select all system files (including **Machine Registry** and **User Registry**) and back them up as described in [System Files Backup](#).
- 4) Copy the backup file to the mobile computer(s) to clone.
- 5) On the mobile computer(s) to clone, run Backup Utility as mentioned in [Launch Backup Utility](#).

Backup Utility launches on the mobile computer(s) to clone.

- 6) Perform system files restoration as described in [System Files Restoration](#).

The mobile computer(s) is/are cloned.

BUTTON ASSIGNMENT

Button Assignment is a utility to redefine some physical keys to deliver the functions they weren't originally obliged with. The re-definable keys are:

- ▶ SCAN key
- ▶ Left/right side-triggers
- ▶ [*] Asterisk key
- ▶ [#] Hash key

LAUNCH BUTTON ASSIGNMENT

To launch Button Assignment:

- 1) On Start screen, tap **CipherLabUtilities**  .
CipherLabUtilities open.

- 2) Tap Button Assignment icon  .

Button Assignment opens showing a screen with an elevation shot of the mobile computer with each re-definable key associated with a GUI button that can be tapped onscreen to open a defining (setting) page.



REDEFINE



To assign a new function for a re-definable key:

- 1) Launch Button Assignment as described in [Launch Button Assignment](#).
Button Assignment launches

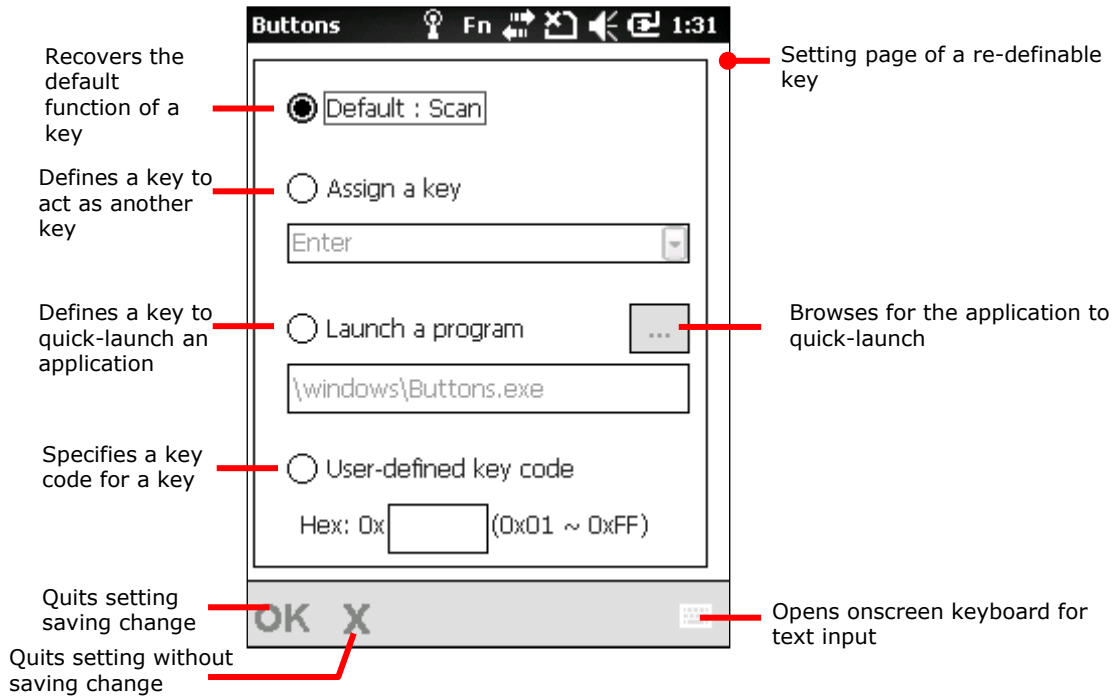
- 2) Tap the GUI button of the key to re-define.
Setting page opens.



Featured setting are enumerated as follows:

Setting	Description
Default	Recovers the default function of a key.
Assign a key	<p>Defines a key to act as another key.</p> <ul style="list-style-type: none"> ▶ This setting comes with a drop-down box that becomes available when the setting is selected. Tap the drop-down arrow  and select among the drop-downs. ▶ If the key desired isn't included, try to specify key code as described in User-defined key code.
Launch a program	<p>Defines a key to quick-launch an application.</p> <ul style="list-style-type: none"> ▶ This setting comes with an [...] ellipsis button  and a field that become available when the setting is selected. Tap the ellipsis button and browse for the executable file of the application to launch, or manually enter the path to the application's executable file in the field.
User-defined key code	<p>Specifies a key code for a key.</p> <ul style="list-style-type: none"> ▶ This setting comes with a text field that becomes available when the setting is selected. Enter the hex value of the desired key's key code in the text field.

RECOVER DEFAULTS

To restore all definable keys to their respective default functions:

- 1) Launch Button Assignment as described in [Launch Button Assignment](#).
Button Assignment launches.
- 2) Tap **Reset** button.
All re-definable keys are brought back to default functions.

To restore an individual re-definable key to its default function:

- 1) Launch Button Assignment as described in [Launch Button Assignment](#).
Button Assignment launches.
- 2) Tap the GUI button of the key to return to default.
The setting page opens.
- 3) Select **Default**.
- 4) Tap the bottom-left **OK**.
The key recovers its default function.

GPS VIEWER

The mobile computer includes a GPS module (GPS hardware). This module communicates with Global Positioning System and discovers your location on earth if it has a piece of GPS software to work with. As previously mentioned in [Launch GPS & AGPS](#), the GPS module auto turns on once GPS software launches on the mobile computer.

The preinstalled GPS Viewer is such GPS software. It streams NMEA-based data from the GPS hardware through GPSID.

Also as per [Launch GPS & AGPS](#), any GPS software on the mobile computer receives data from GPS hardware through COM7. GPS Viewer is no exception. COM7 opens and readies to stream data as soon as any GPS software launches on the mobile computer.

COM7 Serial Port Property:

Item	Value
Baud Rate	57600 bit/s
Data Bits	8
Parity	None
Stop bits	1

LAUNCH GPS VIEWER

To launch GPS Viewer:

- 1) On Start screen, tap **CipherLabUtilities**  .
CipherLabUtilities opens.

- 2) Tap GPS Viewer icon  .

GPS Viewer opens showing **Status** tabbed page. GPS module turns on. COM7 opens.

If there is clear view of sky, GPS module auto-searches for available satellites in the big blue, synchronizes time, and gets location. Time, location, signal strength and so on then display onscreen.

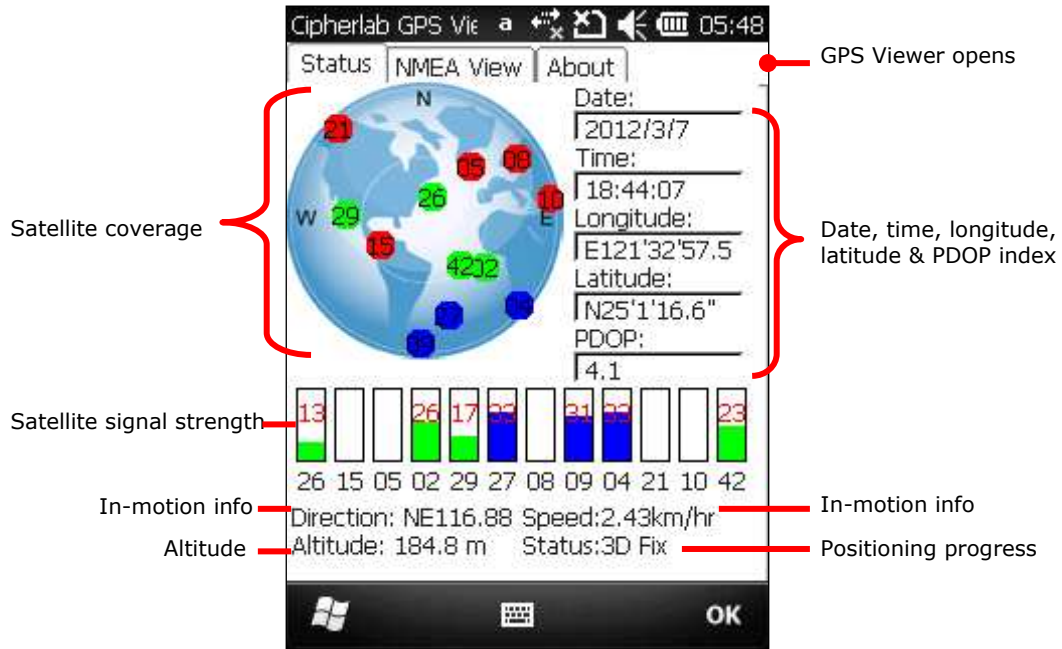

- ▶ Red for no signal (< 9 dB)
- ▶ Green for fair signal strength (10 ~ 29 dB)
- ▶ Blue for strong signal strength (30 ~ 50 dB)

Item	Description
Date, Time	Current date and time
Longitude, Latitude, Altitude	Together they deliver user's location on earth
PDOP	Positional (3D) Dilution of Precision, an indicator about the relationship between the error in user position and the error in satellite position. <ul style="list-style-type: none"> ▶ Good positioning has small PDOP values, such as 3. Values greater than 7 are considered poor
Direction	Direction when user's in motion
Speed	Speed (relative speed) when user's in motion
Status	Delivers positioning progress. <ul style="list-style-type: none"> ▶ When the message shown transits from "Tracking", "2D Fix" to "3D Fix", the latitude, longitude and altitude are calculated.

Note: (1) For external GPS receiver, set a hardware COM port for it by Start screen | **Settings** | **System** | **External GPS** | **Hardware** tabbed page.
 (2) To speed up initial startup, download ephemeris by Start screen | **Settings** | **System** | **GPS Manager**.

VIEW NMEA-BASED DATA

The data standard for GPS communication is NMEA. NMEA use a simple serial protocol to define data syntax. GPS Viewer enables viewing such NMEA data streamed from GPS hardware to software (the application layer). To view NMEA data:

- 1) Launch GPS Viewer as described in [Launch GPS Viewer](#).

GPS Viewer opens showing **Status** tabbed page.

- 2) Tap **NMEA View** tab.

NMEA View tabbed page opens.

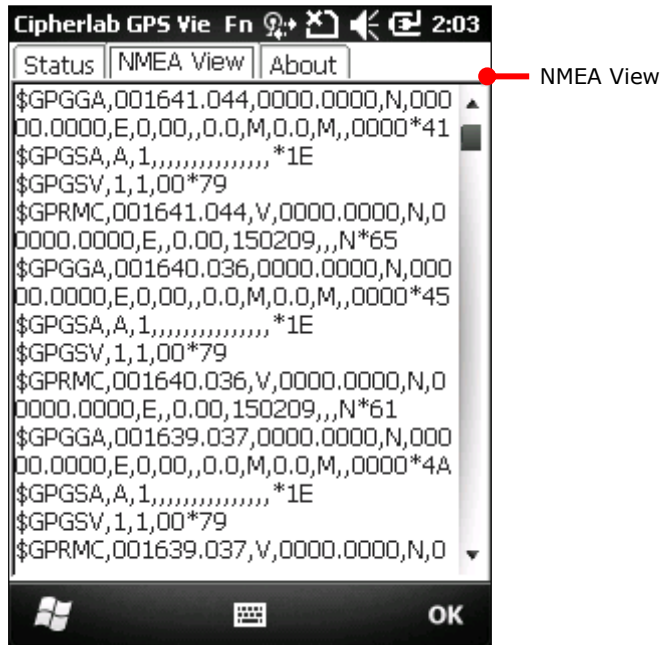

SIGNATURE UTILITY

Signature utility captures, views and edits signature files.

LAUNCH SIGNATURE UTILITY

To launch Signature utility:



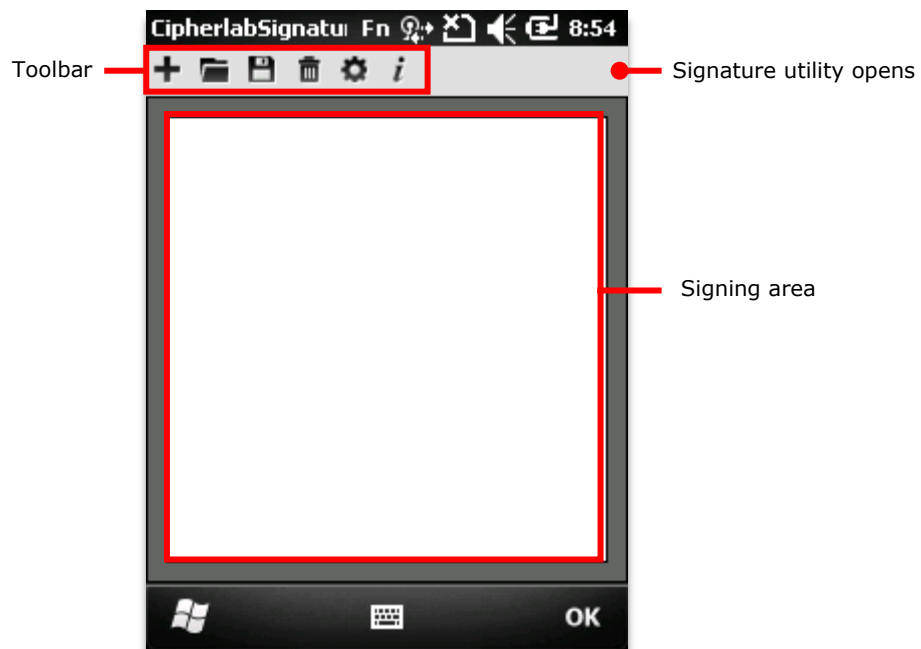

- 1) Open Start screen
Start screen opens.
- 2) Tap Signature icon.

Signature utility opens showing a toolbar along the top and a signing area within its window.



TOOLBAR & SIGNING AREA

Toolbar features a few icons to launch actions from the utility while signing area receives user's signature.



Toolbar icon	Description
+	Creates a new file.
	Loads a signature image.
	Saves the affixed signature to an image file.
	Clears signing area.
	Opens preferences settings.
	Views utility info including developer and software version.

CAPTURE SIGNATURES

To capture signature:

- 1) Launch Signature utility as described in [Launch Signature Utility](#).
Signature utility launches.
- 2) Use the stylus to sign a name in the signing area.



- 3) Tap  icon to save the signature as an image in BMP, JPG or Locus format.
OR
Tap  icon to discard the signature and sign again.
- 4) Tap the "OK" command on Softkey bar to quit Signature utility.

VIEW OR EDIT EXISTING SIGNATURES

To view the existing signature(s) on the storage of the mobile computer:

- 1) Launch Signature utility as described in [Launch Signature Utility](#).
Signature utility launches.
- 2) Tap  icon on toolbar.
The utility opens a screen asking where and which file type of signature to view.
- 3) Browse where to view the signature, and select which file format of signature to view.
The prospective signature file is listed.
- 4) Tap the signature file to view.
The file opens onscreen overlaid by a dialog asking if you want to modify the opened signature file.
- 5) Confirm **Yes** if you want to change the opened signature.

OR

Confirm No if you only want to view it.

Note: Signature utility loads images of maximum 640 x 480 pixels. If it tries to load an image beyond said limit, an error message will prompt and the image cannot be opened.

PREFERENCES

The utility supports preferences settings which change the utility's behaviours when it is used. Users are able to change the size and color of the signing pen stroke, and customize the background color of the signing area.

To access the utility's preferences settings:

- 1) Launch Signature utility as described in [Launch Signature Utility](#).

Signature utility launches.

- 2) Tap  icon on toolbar.

Preferences settings open showing **Pen Width** tabbed page.

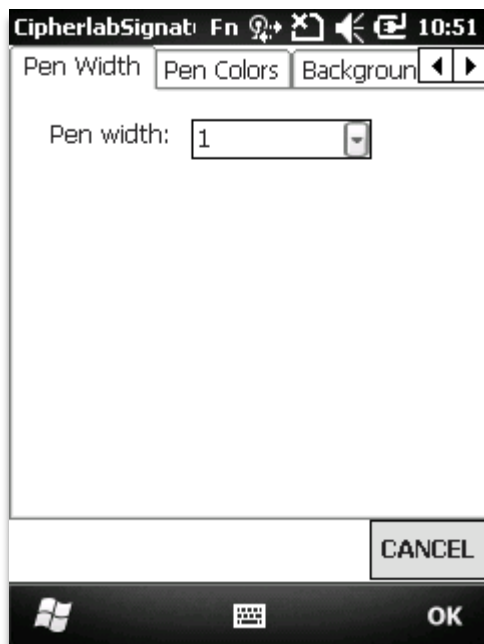

- 3) Select between **Pen Width**, **Pen Colors** and **Background Colors** tabs to customize signing preferences.
- 4) Tap the "OK" command to quit setting saving change, or tap **CANCEL** label to quit setting without saving change.

MANAGE MOBILE COMPUTER

This chapter guides you to the system settings featured by the O.S. Access these settings to define how the mobile computer looks, sounds, stores/secure your data, manages the applications, or exchanges data with your networks or other devices.

This chapter also includes a section detailing the mechanism you follow suit to update O.S. image.

IN THIS CHAPTER

Update O.S. Image	210
System Settings	216

UPDATE O.S. IMAGE

O.S. image upgrade helps optimize the mobile computer's performance and functionality. The upgrade relies on CipherLab's **OS Update Tool**, a utility to run on your PC to get the job done. This utility brings the upgrades of O.S. image and splash (booting logo) to the mobile computer. Contact Cipherlab's sales representative in your local area for the utility and update releases.

There are three approaches to upgrade O.S. image – USB update, SD card auto & manual updates. Follow through the steps below to carry out upgrades.

USB UPGRADE

To USB-upgrade O.S. image:

- 1) Connect the mobile computer and your PC as mentioned in [Sync Partnership](#).
- 2) Run CipherLab **OS Update Tool** on your PC.

CipherLab **OS Update Tool** opens.

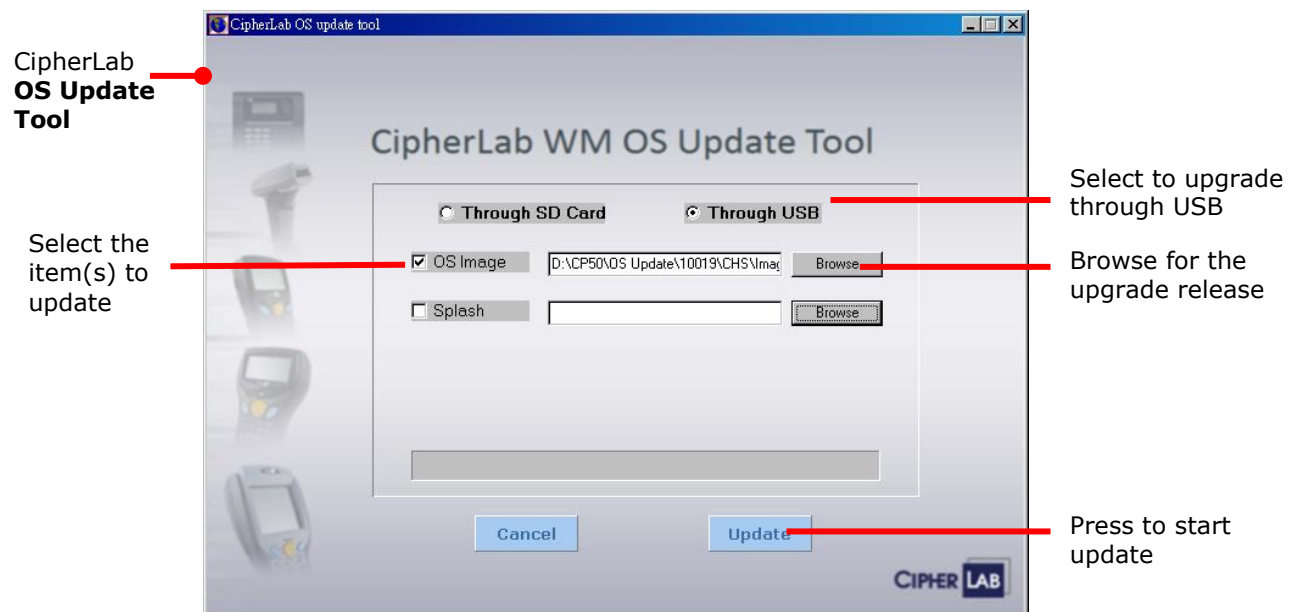

- 3) Select **Through USB**. Select the item(s) to upgrade and browse for the upgrade release.

4) Press **Update**.

The selected item(s) auto-start(s) to upgrade. The mobile computer displays a screen such as below. Once upgrade finishes, you are prompted to restart the mobile computer.

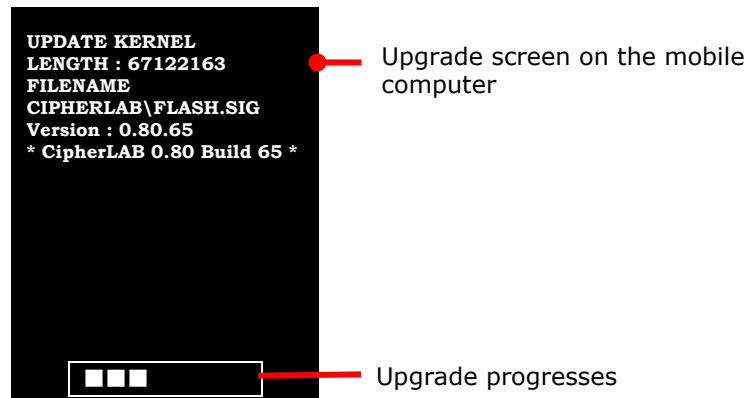

5) Restart the mobile computer.

It takes longer than usual for the mobile computer to restart by the support of the new O.S. image (and/or splash image).

Right before the mobile computer boots into [Today Screen](#), you are prompted to calibrate touchscreen.

6) Follow onscreen instruction to calibrate touchscreen as described in [Calibration](#).

When calibration finishes, Today screen opens.

Note: If USB update should fail, close the Anti-Virus application on your PC and try again.

SD CARD AUTO UPDATE

To auto-upgrade O.S. image with a SD card:

- 1) Have a SD card. Let it mount your PC as a removable disk.
- 2) Run CIPHERLAB **OS Update Tool** on your PC.

CIPHERLAB **OS Update Tool** opens.

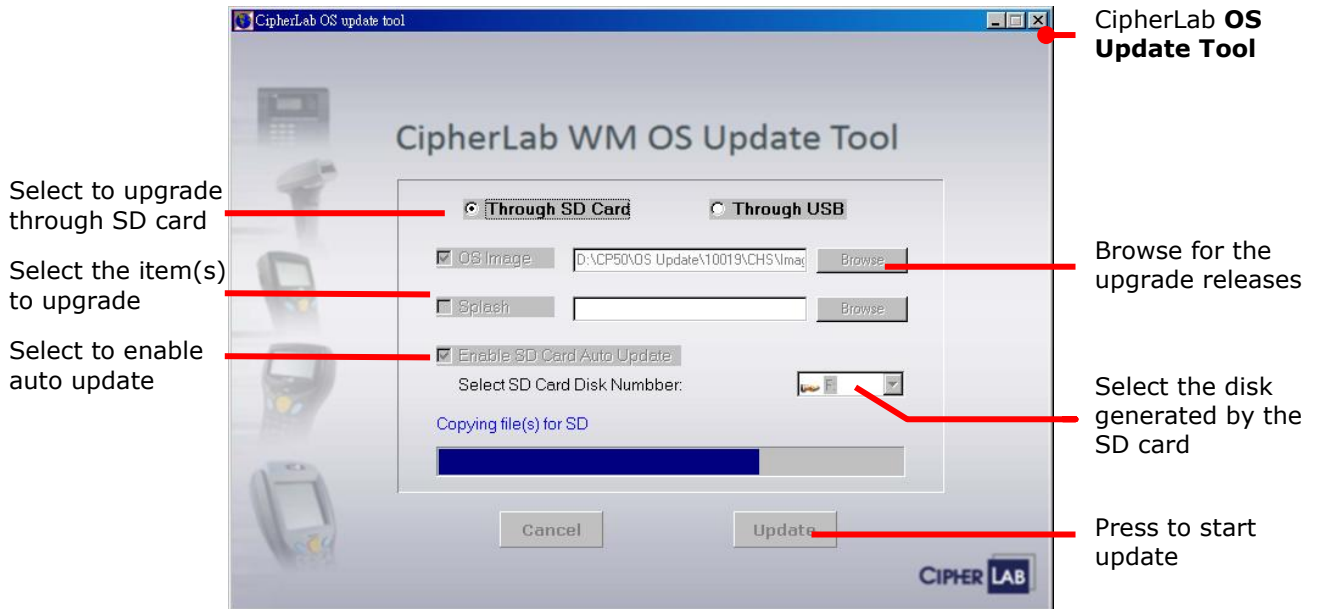

- 3) Select **Through SD Card**.
- 4) Select the item(s) to upgrade and browse for the upgrade release.
- 5) Select **Enable SD Card Auto Update**, and select the disk generated by your SD card.
- 6) Press **Update** button.

CIPHERLAB **OS Update Tool** proceeds to copy all the files required for your desired upgrades onto the SD card.

Once copy finishes, the tool prompts "Copying file(s) is done successfully".

- 7) Unmount and dismount the SD card from your PC.
- 8) Install the SD card into the mobile computer as described in [Insert SD Card](#).

- 9) Power on the mobile computer.

The selected item(s) auto-start(s) to upgrade. The mobile computer displays a screen such as below. Once upgrade finishes, you are prompted to restart the mobile computer.

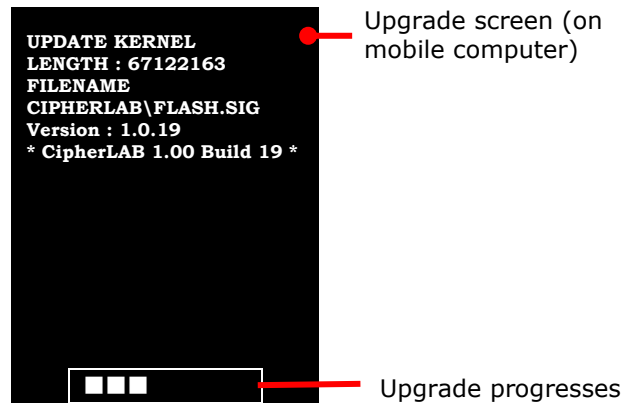

- 10) Before restarting the mobile computer, remove the SD card from the mobile computer, lest the mobile computer reboots to upgrade the O.S. image again.
- 11) Restart the mobile computer.

It takes longer than usual to restart the mobile computer by the support of the new O.S. image(and/or splash image). Right before the mobile computer boots into [Today Screen](#), you are prompted to calibrate touchscreen.

- 12) Follow onscreen instruction to calibrate touchscreen as mentioned in [Calibration](#).
[Today Screen](#) opens when calibration finishes.

SD CARD MANUAL UPDATE

To manual-upgrade O.S. image with a SD card:

- 1) Have a SD card. Let it mount your PC as a removable disk.
- 2) Run CipherLab **OS Update Tool** on your PC.

CipherLab **OS Update Tool** opens.

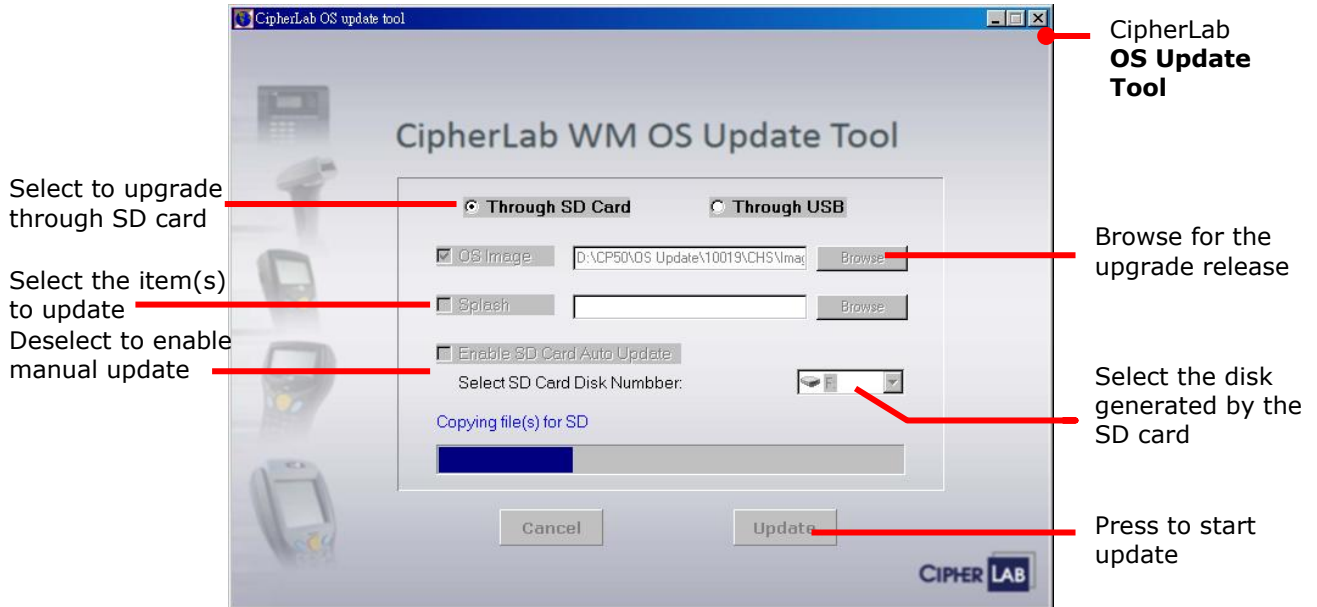

- 3) Select **Through SD Card**.
- 4) Select the item(s) to update and browse for the upgrade releases.
- 5) For **Select SD Card Disk Number** option, select the disk generated by your SD card. Deselect **Enable SD Card Auto Update**.
- 6) Press **Update** button.

OS Update Tool proceeds to copy all the files required for your desired upgrade to the SD card.

Once copy finishes, the tool prompts "Copying file(s) is done successfully".

- 7) Unmount and dismount the SD card from your PC.
- 8) Install the SD card in the mobile computer as described in [Insert SD Card](#).
- 9) Hard-reset the mobile computer as mentioned in [Cold Boot \(Hard Reset\)](#).
The mobile computer shuts down and starts up again with a very short vibration.
- 10) Just within a fraction of a second after said vibration, simultaneously press physical Esc key and backspace key ←.

The selected item(s) start(s) to upgrade automatically. The mobile computer displays a screen as displayed on page [213](#). Once upgrade finishes, you are prompted to restart the mobile computer.

11) Restart the mobile computer.

It takes longer than usual to restart the mobile computer by the support of the new O.S. image (and splash image). Right before the mobile computer boots into [Today Screen](#), you are prompted to calibrate touchscreen.

12) Follow onscreen instruction to calibrate touchscreen as mentioned in [Calibration](#).

[Today Screen](#) opens when calibration finishes.

SYSTEM SETTINGS

This section guides to Windows Embedded Handheld 6.5 system settings. Access these settings to define how the mobile computer looks, sounds, stores/secures data, manages applications, or exchanges data with networks or other devices.

To access system settings:

Open Start screen, tap **Settings** icon . System settings open:



Bluetooth

Configures Bluetooth data connection. See [Use Bluetooth](#).



Clock & Alarms

Sets clock, calendar, time zone, and set up at most three alarms for reminders.



Home (Today)

Customizes the background and displayed items on Today screen. See also [Customize Today Screen](#).



Lock

Sets up screen lock to limit access to the mobile computer. See also [Set Screen Lock](#).



Power

Monitors main and backup battery level, and sets up power plan. See [Monitor Battery Level](#).



Connections Folder

Leads to the settings for radios, USB, and others. See also [Connections Folder](#).



Personal

Accesses phone settings and button assignment tool. It also leads through

creating the information about the owner of the mobile computer.



System

Leads to [System Folder](#), where the hardware and software on the mobile computer can be configured and their info can be viewed.



Microsoft My Phone

Synchronizes contacts, calendars, tasks, and so on with a **Microsoft My Phone** account. A Microsoft account is needed to sign in.



SOUNDS & NOTIFICATIONS

Configures the mobile computer’s phone ringtones, how the mobile computer vibrates, how a notification is received, how an alarm sounds, or how music or other media with audio plays, and related settings.

Note Sounds & Notifications doesn’t turn on/off the audio from music, videos, and other media. Said audio should be silenced in the applications that run them.

Sounds & Notifications features two tabbed page, **Sounds** and **Notifications**:

SOUNDS TABBED PAGE

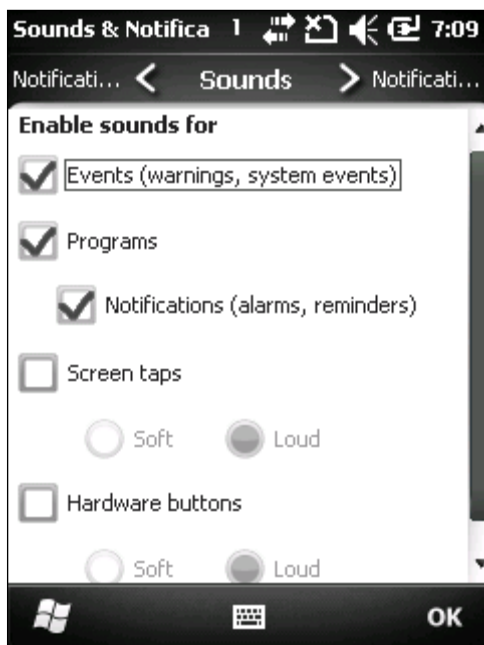

Mutes/unmutes the sounds for system events, applications, screen taps, physical key pressing.

NOTIFICATIONS TABBED PAGE

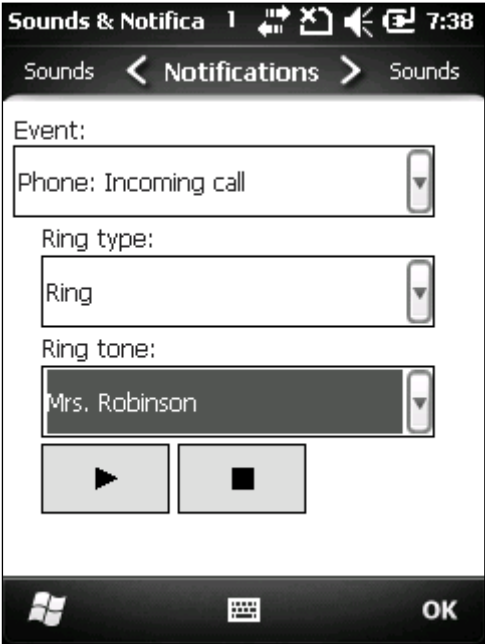

Configures the ring type for a number of system events such as incoming calls, established or disconnected connections and so on.

CONNECTIONS FOLDER

This section guides to system settings' **Connections Folder**.

Open Start screen, tap **Settings | Connections** .

Connections folder opens:



Beam

For Windows Mobile and Windows Embedded Handheld, "beam" is typically known as data sharing between handheld devices through an infrared wireless connection.

Open **Beam** application and select **Receive all incoming beams** to enable Bluetooth-based data exchange with other devices.



Domain Enroll

Connects to a SCMDM (System Center Mobile Device Manager) server with an enrollment ID and password. SCMDM enables the management of multiple mobile computers.



USB Connection

Sets the USB connection between **ActiveSync** and **Mass Storage** when the mobile computer connects to a Windows-based PC. **ActiveSync** is the default.



USB TO PC

Enables/disables RNDIS (Remote Network Driver Interface Specification). Open **USB to PC** and deselect **Enable advanced network functionality** to disable RNDIS and enable PPP.

Note deselecting **Enable advanced network functionality** will disable "[USB Internet Sharing](#)".



NETWORK CARDS

It opens Wi-Fi settings that feature two tabs – **Wireless** and **Network Adapters**.

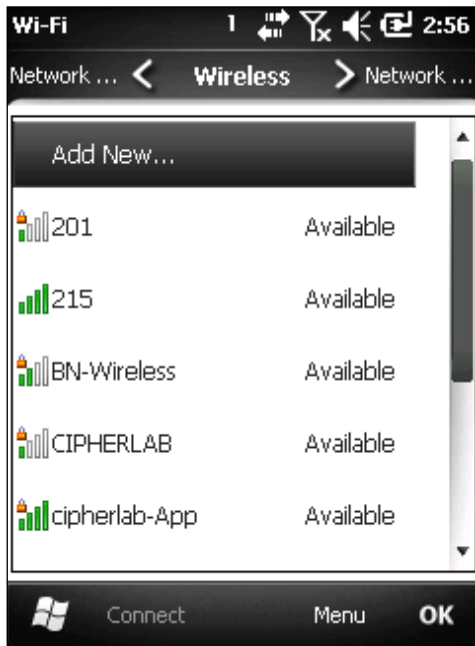

WIRELESS TABBED PAGE

Wi-Fi needs to be on before this page can deliver service. Turn on Wi-Fi by tapping the “Menu” command  on [Softkey bar](#) and tap **Turn on Wi-Fi**.

This page searches for Wi-Fi networks, selects the network to connect, and adds networks that don’t broadcast its SSID or fall out of reach.

Wi-Fi Advanced Settings

On Wi-Fi’s Wireless tabbed page, tap the “Menu” command  on [Softkey bar](#) then tap **Advanced** to access Advanced Wi-Fi Settings for the following:

- ▶ Turning on/off notifications of available networks.
- ▶ Defining the time to turn off Wi-Fi if the connection keeps failing.
- ▶ Defining the network to access, only hotspots or only computer to computer (ad-hoc) or all.

NETWORK ADAPTERS TABBED PAGE

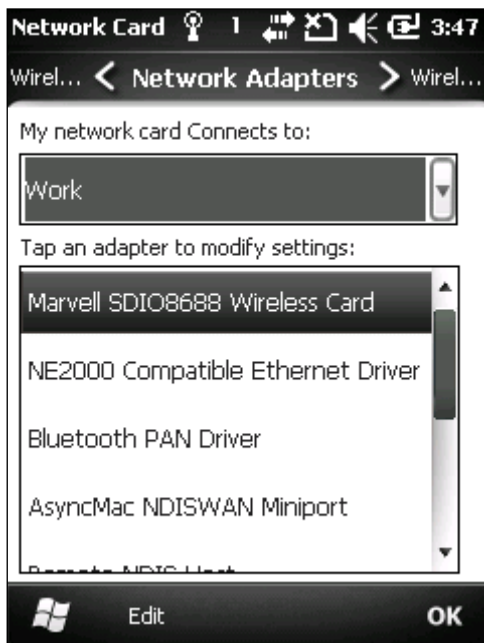

Modifies network card settings such as static IP connection, and configures where the network cards connect to, Internet or your work network. See also [Connect by Static IP](#).



WIRELESS MANAGER

Enables/disables the radios of Wi-Fi, Bluetooth, phone, and mobile data. It also limits mobile data to 2G only. See [Use Only 2G Networks](#).

Wireless Manager opens showing a few entries:

- ▶ **All:** Turns on/off all the radios on the mobile computer except GPS. (GPS is turned off by losing GPS-dependent applications).
- ▶ **Wi-Fi:** Turns on/off Wi-Fi.
- ▶ **Bluetooth:** Turns on/off Bluetooth.
- ▶ **Phone:** Turns on/off phone and mobile data.

Tap the “Menu” command  on Softkey bar to [Disconnect Cellular Data](#) or access [Wi-Fi Settings](#), [Bluetooth Settings](#), and [Phone Settings](#).

Setting	Description
Disconnect Cellular Data	Turns off mobile data without turning off phone.
Wi-Fi Settings	Opens Wi-Fi settings. See Network Cards .
Bluetooth Settings	<p>Bluetooth settings feature three tabs – Devices, Mode and COM Ports.</p> <p>Devices tabbed page:</p> <ul style="list-style-type: none"> - Searches for devices and selects devices to connect. - Edits, disconnects from, and unpairs from connected devices. - Edits, reconnects to, and unpairs from disconnected devices. <p>Mode tabbed page:</p> <ul style="list-style-type: none"> - Turns on/off Bluetooth. - Hides/reveals the mobile computer from/to other Bluetooth devices. <p>COM Ports tabbed page:</p> <ul style="list-style-type: none"> - Sets up COM ports for a paired device. - Edits an existing port.
Phone Settings	<p>Phone settings are only available when a SIM card is assembled and phone is turned on.</p> <p>Phone settings feature six tabs – Sounds, Security, Services, Network, PAP/CHAP, GSM/UMTS.</p> <p>Sounds tabbed page</p> <ul style="list-style-type: none"> - Configures phone ring type, ringer or vibration. - Configures phone ring tone. - Configures keypad tones. <p>Security tabbed page</p> <ul style="list-style-type: none"> - Enables/disables PIN code(s) for the inserted SIM

	<ul style="list-style-type: none">- card. Edits the existing PIN code(s) of the inserted SIM card. <p>Services tabbed page</p> <ul style="list-style-type: none">- Call Barring: Blocks certain types of incoming and outgoing calls.- Caller ID: Sets if your phone number is displayed to whom you call.- Call forwarding: Configures how to forward your calls when you're on a phone already, you didn't answer and so on.- Call waiting: Configures whether to be noticed of any incoming call during a call. See also Manage Multiple Calls.- Voice mail & Text Messages: Sets the phone number that accesses voicemails. As long as a number is set here, you are able to quickly access voicemail box by Phone application's Speed Dial. See also Check Voicemails and Speed Dial.- Fixed Dialing: When your mobile carrier supports fixed dialing, phone can be set to place calls only to the fixed dialing numbers (FDN) saved on SIM card. Enable/disable FDN by selecting/deselecting Enable fixed dialing. Tap the "Menu" command  on Softkey bar to add an FDN number to SIM card. <p>Network tabbed page</p> <ul style="list-style-type: none">- Current network: Delivers the mobile network currently connected to.- Network selection: Configures how to select network, automatic or manual.- Find Network: Registers other mobile networks.- Set Networks: Selects preferred networks and orders them to your preference. <p>PAP/CHAP tabbed page</p> <ul style="list-style-type: none">- Selects Point-to-Point Protocol authentication between CHAP, PAP or both. <p>GSM/UMTS tabbed page</p> <ul style="list-style-type: none">- Select whether to limit mobile data to only 2G, 3G or on automatic.
--	--



CONNECTIONS (MANAGER)

Tweaks mobile data connection and provides two tabbed pages – **Tasks** and **Advanced**.

Page	Description						
Task tabbed page	Sets where mobile data connects to, to Internet (My ISP), or to an internal network (intranet) or a VPN (My Work Network).						
	<table border="1"> <thead> <tr> <th>Setting</th> <th>Description</th> </tr> </thead> <tbody> <tr> <td>My ISP</td> <td> <p>Sets up mobile data connection to the Internet. It provides two links – Add a new modem connection and Manage existing connection. The latter is only available after a connection is set up. See also Edit & Add Access Point.</p> <ul style="list-style-type: none"> ▶ Add a new modem connection <p>Creates a mobile data connection to Internet. Request your mobile carriers for the information needed. See also Cellular Data Setup.</p> ▶ Manage existing connections <p>Edits existing mobile data connection to Internet.</p> </td> </tr> <tr> <td>My Work Network</td> <td> <p>Creates mobile data connection to an internal network (intranet) or a VPN. For enterprise network to access Internet, proxy server setting which is usually required is supported.</p> <ul style="list-style-type: none"> ▶ Add a new modem connection <p>Creates a mobile data connection to internal network (intranet) or VPN. Request network administrator for the information needed.</p> ▶ Add a new VPN server connection <p>Sets up a VPN connection. Request your VPN administrator for the details required.</p> <p>After a VPN is set up, Add a new VPN server connection changes to Edit my VPN servers.</p> ▶ Set up my proxy server <p>Sets up the proxy server by which an enterprise network connects to Internet.</p> <p>After a proxy server is set up, Set up my proxy server changes to Edit my proxy server.</p> ▶ Manage existing connections <p>Edits existing mobile data connection to internal network (intranet) or VPN. Request your network administrator for the related information.</p> </td> </tr> </tbody> </table>	Setting	Description	My ISP	<p>Sets up mobile data connection to the Internet. It provides two links – Add a new modem connection and Manage existing connection. The latter is only available after a connection is set up. See also Edit & Add Access Point.</p> <ul style="list-style-type: none"> ▶ Add a new modem connection <p>Creates a mobile data connection to Internet. Request your mobile carriers for the information needed. See also Cellular Data Setup.</p> ▶ Manage existing connections <p>Edits existing mobile data connection to Internet.</p> 	My Work Network	<p>Creates mobile data connection to an internal network (intranet) or a VPN. For enterprise network to access Internet, proxy server setting which is usually required is supported.</p> <ul style="list-style-type: none"> ▶ Add a new modem connection <p>Creates a mobile data connection to internal network (intranet) or VPN. Request network administrator for the information needed.</p> ▶ Add a new VPN server connection <p>Sets up a VPN connection. Request your VPN administrator for the details required.</p> <p>After a VPN is set up, Add a new VPN server connection changes to Edit my VPN servers.</p> ▶ Set up my proxy server <p>Sets up the proxy server by which an enterprise network connects to Internet.</p> <p>After a proxy server is set up, Set up my proxy server changes to Edit my proxy server.</p> ▶ Manage existing connections <p>Edits existing mobile data connection to internal network (intranet) or VPN. Request your network administrator for the related information.</p>
	Setting	Description					
My ISP	<p>Sets up mobile data connection to the Internet. It provides two links – Add a new modem connection and Manage existing connection. The latter is only available after a connection is set up. See also Edit & Add Access Point.</p> <ul style="list-style-type: none"> ▶ Add a new modem connection <p>Creates a mobile data connection to Internet. Request your mobile carriers for the information needed. See also Cellular Data Setup.</p> ▶ Manage existing connections <p>Edits existing mobile data connection to Internet.</p> 						
My Work Network	<p>Creates mobile data connection to an internal network (intranet) or a VPN. For enterprise network to access Internet, proxy server setting which is usually required is supported.</p> <ul style="list-style-type: none"> ▶ Add a new modem connection <p>Creates a mobile data connection to internal network (intranet) or VPN. Request network administrator for the information needed.</p> ▶ Add a new VPN server connection <p>Sets up a VPN connection. Request your VPN administrator for the details required.</p> <p>After a VPN is set up, Add a new VPN server connection changes to Edit my VPN servers.</p> ▶ Set up my proxy server <p>Sets up the proxy server by which an enterprise network connects to Internet.</p> <p>After a proxy server is set up, Set up my proxy server changes to Edit my proxy server.</p> ▶ Manage existing connections <p>Edits existing mobile data connection to internal network (intranet) or VPN. Request your network administrator for the related information.</p> 						

Advanced tabbed page	Featured settings are:	
	Setting	Destription
	Select Networks	Sets which network to auto use when accessing Internet or a private network.
	Dialing Rules...	Sets where you are dialing from so you don't have to create a new connection on a different location.
Exceptions...	Enters the address of the intranet to access in case it includes a period.	

PERSONAL FOLDER

This section guides to **Personal Folder** .

Open Start screen, tap **Settings | Personal**.

Personal folder opens:

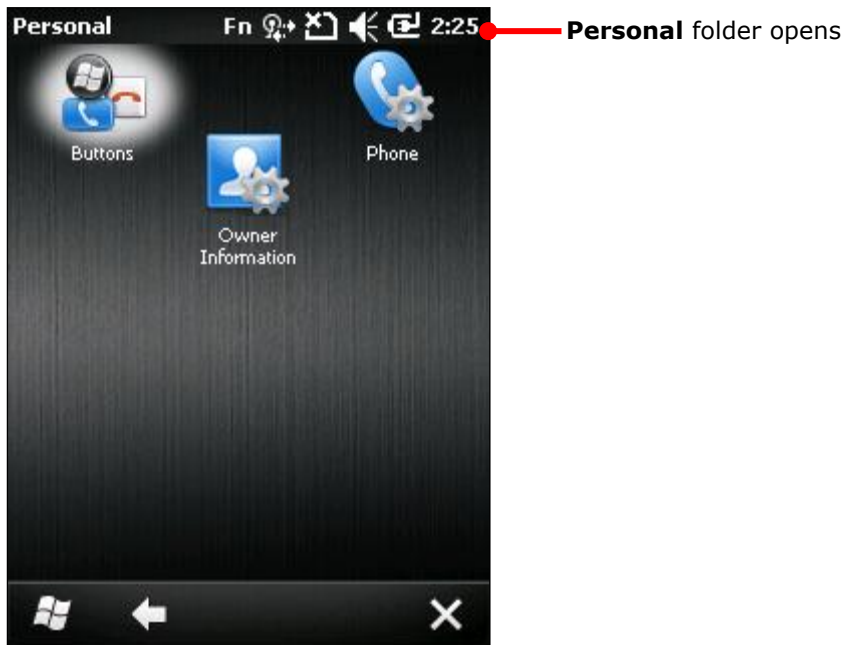

Owner Information

Creates contact info about the owner of the mobile computer and also some notes.



Phone

Accesses phone settings. See [Phone Settings](#).



BUTTONS

Provides two tabs – **Program Buttons** and **Up/Down Control**.

Tabbed Page	Description
Program Buttons	Assigns a button to quick launch an application.
Up/Down Control	An up-down control is a pair of arrow buttons that users tap to increment or decrement a value such as a scroll position or a number displayed in a companion control (called a buddy window). Use this page to customize the delay before repeat and the repeat rate for up/down controls.

SYSTEM FOLDER

This section guides to **System Folder** .

Open Start screen, tap **Settings | System**.

System folder opens:



Certificates

Views or deletes the digital certificates used by some applications to access some secured networks. See also [Install Secure Certificates](#).



Customer Feedback

Submits feedback about Windows Embedded Handheld 6.5 to help Microsoft improve the software for this platform.



Encryption

Encrypts the files placed to external SD card so the encrypted files are only readable on the mobile computer.



Error Reporting

Enables/disables the mobile computer to auto-collect and report errors to Microsoft to help them improve products.



G-Sensor

- ▶ Enables suspension when the mobile computer is faced down.
- ▶ Enables automatic screen orientation when the mobile computer turns sideways, upright or upside down.



GPS Manager

- ▶ Downloads or updates ephemeris data, which is valid for seven days according to system date and time. The last download time displays at the lower left of the

screen.



Managed Programs

Views the applications remotely installed by your domain’s system administrator.



Memory

Delivers how the internal/external memories are used. See also [Check Storage](#).



Remove Programs

Views and removes the acquired (non-inherent) applications. See also [Uninstall Application](#).



Screen

Calibrates touchscreen, smoothens the edges of screen fonts, and adjusts screen text size.



Task Manager

Monitors the memory and CPU resources consumed by each running application and cached process. It also closes applications and switches screen between opened applications. See also [Task Manager](#).



KEYPAD BACKLIGHT

Controls keypad backlight, which is auto off after five-second idleness by default.



BACKLIGHT

Sets screen timeout and brightness.

Two tabs are featured – **External Power** and **Battery Power**.

Tabbed Page	Description
External Power	Sets the screen timeout and brightness on external power.
Battery Power	Sets the screen timeout and brightness on battery power. <ul style="list-style-type: none"> ▶ Adjust the screen to the dimmest comfortable brightness to save power. ▶ See also Adjust Backlight.



POWER

Displays battery level and sets up power plans. Two tabs are featured – **Battery** and **Advanced**.

Tabbed Page	Description
Battery	Delivers main battery type and remaining power of both main & backup batteries.
Advanced	Sets the screen timeouts on battery power and external power. See also Monitor Battery Level .



DEVICE INFORMATION

Displays some of the mobile computer’s info such as manufacturer, software/firmware version, memory capacity and so on. See also [Check Storage](#).

Here also displays the mobile computer’s **Device Config**, a sequence of paired digits, with each delivering a piece of information about the hardware integrated on the mobile computer. Coding rule tabulated as below:

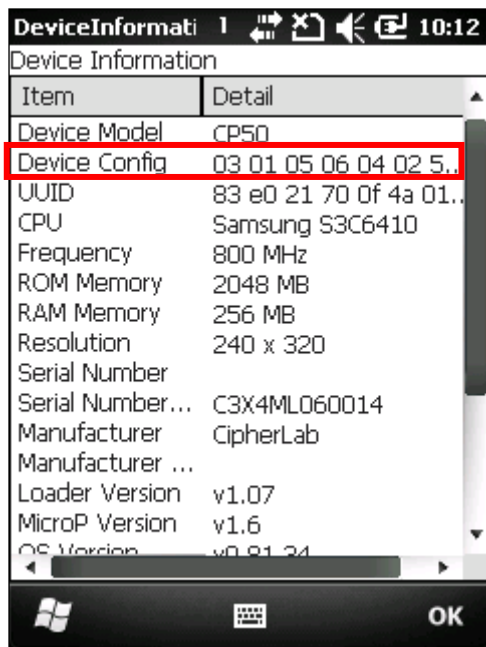

Digit Pair	Hardware	Code
1 st	Barcode Reader	0: None 1: Reserved 2: Laser 3: 2D
2 nd	RFID Reader	0: None 1: RFID
3 rd	Bluetooth / GSM	0: no Bluetooth, no GSM 2: Bluetooth, no GSM 4: GSM, no Bluetooth 5: Bluetooth + GSM
4 th	Wi-Fi / GPS	0: no Wi-Fi, no GPS 1: Wi-Fi(Summit), no GPS 2: Wi-Fi(Marvell), no GPS 3: Wi-Fi (Others), no GPS 4: no Wi-Fi, GPS 5: Wi-Fi(Summit) + GPS 6: Wi-Fi(Marvell) + GPS 7: Wi-Fi(Others) + GPS
5 th	LCD / Camera	0: QVGA, no Camera 1: VGA, no Camera 2: WQVGA, no Camera 4: QVGA + Camera 5: VGA + Camera 6: WQVGA + Camera
6 th	Keypad	0: 29 Keys 1: Reserved 2: QWERTY
7 th	Main board	Manufacture purpose only



ABOUT

Views OS information. It features three tabs – **Version**, **Device ID** and **Copyright**.

Tabbed Page	Description
Version	Displays O.S. version details, and shows brief descriptions of major hardware units.
Device ID	Sets a name and description for the mobile computer to identify itself to other computers.
Copyright	Displays OS’ legal information.



EXTERNAL GPS

Configures external GPS receiver in use by the mobile computer. Three tabs are featured – **Access**, **Programs** and **Hardware**.

Tabbed Page	Description
Programs	Sets the software port for GPS software and location-aware applications to stream GPS data. See also Use External GPS Receiver with Bluetooth .
Hardware	Sets the hardware COM port for the external GPS receiver. See also Use External GPS Receiver with Bluetooth .
Access	Enables/disables system's access to the external GPS device.



REGIONAL SETTINGS

Controls how to display numbers, currency, date, time, etc on the mobile computer. Featured tabs are – **Region**, **Number**, **Currency**, **Time** and **Date**.

Tabbed Page	Description
Region	Sets the region of your locale to display numbers, amount of money, time/date and other info.
Number	Sets how to display numbers.
Currency	Sets how to display currency symbols and amount of money.
Time	Sets how to display time.
Date	Sets how to display date.

SPECIFICATIONS

PLATFORM, PROCESSOR & MEMORY

Operating System & CPU

O.S. Version	Microsoft Windows Embedded Handheld 6.5
CPU	Samsung S3C6410 800MHz

Memory

ROM	2GB NAND flash memory
RAM	256MB DRAM
Expansion Slot	One MicroSD card slot <ul style="list-style-type: none">▶ MicroSDHC from 4GB to 32GB supported▶ MicroSD from 256MB to 4GB supported

COMMUNICATIONS & DATA CAPTURE

Communications

USB Host/Client	USB 1.1 / USB 2.0
WPAN	Built-in module for Bluetooth version 2.0 + EDR Class 2 connectivity
WLAN	Built-in module for 802.11b/g networking <ul style="list-style-type: none">▶ AzureWave AW-GH381
WWAN	Ordering Option - built-in module for GSM/HSPA+ <ul style="list-style-type: none">▶ Cinterion PH8

Data & Image Capture

Digital Camera	5 mega-pixel CMOS type
Barcode Reader	Ordering options include <ul style="list-style-type: none">▶ Laser (Symbol SE955 with CipherLab decoder board)▶ 2D (Symbol SE4500-DL with PL4507 decoder board)
HF RFID Reader	Ordering options include <ul style="list-style-type: none">▶ HF RFID reader supports ISO14443A and B, 15693 and Secure Access Module (SAM).

ELECTRICAL CHARACTERISTICS

Batteries

Main Battery Pack	Rechargeable Li-ion battery – 3.7 V, 3300 mAh Charging time: 4 hours	
Backup Battery	Rechargeable Lithium battery – 25 mAh Data retention for 0.5 hours Charging time: 8 hours	

Power Adapter

Power Supply Cord with Universal Power Adapter	Input	AC 100~240V, 50/60 Hz
	Output	DC 5 V, 3 A for Charging & Comm. Cradle
Vehicle Charging Cable for Vehicle Charger/Cradle	Input	DC 12~24 V
	Output	DC 5V, 3A

Working Time (Laser, one scan per 20 seconds)

Wi-Fi Mode with 50% backlight	Minimum 10 hours (Wi-Fi in power-saving mode)
3G Mode with 50% backlight	Minimum 10 hours

PHYSICAL CHARACTERISTICS

Color Tap Screen Display

Display	3.5" Transflective TFT-LCD, 65K colors, sunlight readable
Resolution	240 (W) x 320 (L) QVGA size

Keypad

Layout	Numeric or QWERTY keypad
Backlight	White LED backlight for display and keypad

Notifications

Status LED	One triple-color LED that shows Red / Green / Blue colors
Audio	Integrated with speaker (rear) Headset jack – 3.5 mm DIA 4-ring stereo earphone jack with microphone input ▶ Bluetooth headset supported
Vibrator	0.45G force

Enclosures

Materials	Plastic & metal
Dimensions	182 mm (L) x 77.5mm (W) x 29~37 mm (H)
Weight	385g

ENVIRONMENTAL CHARACTERISTICS

Temperature

Operating ^{Note}	-10 °C to 55 °C
Storage	-40 °C to 70 °C (without battery)
Charging	0 °C to 40 °C

Humidity

Operating	10% to 90%, non-condensing
Storage	5% to 95%, non-condensing

Resistance

Impact Resistance	Multiple 1.5m drop onto concrete, 5 drops on each side
Tumble Test	1000 times at 50 cm per applicable IEC tumble spec.
Splash/Dust Resistance	IP 65 per applicable IEC sealing spec.
Electrostatic Discharge	± 15 kV air discharge, ± 8 kV contact discharge

Note: CipherLab doesn't assume the responsibility for the mobile computer's malfunction incurred by the operation outside operating temperature range.

PROGRAMMING SUPPORT

Development Environment & Tools

Integrated Development Environment	Visual Studio 2008 Visual Studio 2005
Software Development Kit	Microsoft SDK System API (DLL) for system configuration Reader API (DLL) for reader configuration

Software & Utilities

Cipherlab software package	<ul style="list-style-type: none"> ▶ Reader Configuration ▶ MIRROR Browser for web application ▶ Terminal Emulation
Third-party software	<ul style="list-style-type: none"> ▶ License Plate Recognition ▶ SOTI MobiControl for remote device control ▶ Naurtech CETerm – Terminal emulator (3270, 5250, VT) and industrial web browser ▶ SYSDEV Kalipso

ACCESSORIES

Accessory Options

- ▶ Pistol Grip
- ▶ USB Cable
- ▶ Hand Strap
- ▶ Belt Holster with Shoulder Strap
- ▶ Protective Cover
- ▶ Charging & Communication Cradle with a spare battery
- ▶ Vehicle Mount
- ▶ Vehicle Charger
- ▶ 4-slot Gang Charger

SCAN ENGINE SETTINGS

Utility **Reader Configuration** (*ReaderConfigMobile.exe*) configures these reader types:

- ▶ 1D Laser (SE955)
- ▶ 2D Imager (SE4500DL)
- ▶ RFID reader

Reader combination allowed is either 1D+RFID or 2D+RFID. Each integration is able to initialize both readers at the same time (dual mode operation). For example, if you press a physical scan key, the mobile computer reads a printed barcode in position or an RFID tag in proximity depending on which one comes first.

Note: (1) 1D and 2D scan engines don't coexist on the mobile computer because they are both barcode readers and the mobile computer allows one barcode reader only.
(2) Run only one reader-controlling utility or application at a time. For example, while running Reader Configuration (*ReaderConfigMobile.exe*), avoid running MIRROR Browser, Terminal Emulation, or any other application that uses ReaderDLL.

IN THIS CHAPTER

Symbologies Supported.....	236
RFID Tags Supported	238

SYMBOLOGIES SUPPORTED

Depending on the available scan engine(s), supported symbologies are different as listed below. For details on configuring associated settings, refer to Appendix II and III.

		Laser	2D
Codabar		✓	✓
Code 11		✓	✓
Code 93		✓	✓
Composite Code		x	✓
MSI		✓	✓
Postal Codes		x	✓
Industrial 25		✓	✓
Misc.		✓	✓
Interleaved 25	Convert to EAN-13	✓	✓
Matrix 25		x	✓
Macro PDF		x	✓
Code 128	Code 128	✓	✓
	GS1-128 (EAN-128)	✓	✓
	ISBT 128	✓	✓
Code 2 of 5	Industrial 25 (Discrete 25)	✓	✓
	Interleaved 25	✓	✓
	Matrix 25	x	✓
	Chinese 25	✓	✓
Code 3 of 9	Code 39	✓	✓
	Trioptic Code 39	✓	✓
	Italian Pharmacode (Code 32)	✓	✓
EAN/UPC	EAN-8	✓	✓
	EAN-13	✓	✓
	Bookland EAN (ISBN)	✓	✓
	UPC-E0	✓	✓
	UPC-E1	✓	✓
	UPC-A	✓	✓
GS1 DataBar (RSS)	GS1 DataBar Omnidirectional (RSS-14)	✓	✓
	GS1 DataBar Truncated	✓	✓
	GS1 DataBar Stacked	✓	✓
	GS1 DataBar Stacked Omnidirectional	✓	✓
	GS1 DataBar Limited (RSS Limited)	✓	✓

	GS1 DataBar Expanded (RSS Expanded)	✓	✓
	GS1 DataBar Expanded Stacked	✓	✓
2D Symbologies	PDF417	✗	✓
	MicroPDF417	✗	✓
	Data Matrix	✗	✓
	Maxicode	✗	✓
	QR Code	✗	✓
	MicroQR	✗	✓
	Aztec	✗	✓

RFID TAGS SUPPORTED

RFID reader supports both reading and writing RFID data. Supported labels include ISO 15693, ISO 14443A and ISO 14443B.

The supported RFID tags:

ID_MOD_MP_RFID		UID Only	Read Page	Write Page
ISO 14443A	Mifare Standard 1K	✓	✓	✓
	Mifare Standard 4K	✓	✓	✓
	Mifare Ultralight	✓	✓	✓
	Mifare DESFire	✓	---	---
	Mifare S50	✓	✓	✓
	SLE44R35	✓	✓	✓
	SLE66R35	✓	✓	✓
ISO 14443B	SR176	✓	✓	✓
ISO 15693	ICODE SLI	✓	✓	✓
	SRF55V02P	✓	✓	✓
	SRF55V02S	✓	✓	✓
	SRF55V10P	✓	✓	✓
	TI Tag-it HF-I	✓	✓	✓
	ST LRI512	✓	✓	✓

Note: Study the specifications of the RFID tags to read.

LASER (SE955)

The tables below list the symbologies settings for 1D laser scan engine (SE955).

SYMBOLGY SETTINGS

Laser Engine	Description	Default
Code 11		Enable
Check digit verification	Decide whether to verify check digits. If the check digit is incorrect, the barcode will not be accepted. <ul style="list-style-type: none"> ▶ Disable ▶ One Check Digit ▶ Two Check Digits 	Disable
Transmit Check Digit	Decide whether to include check digits in the transmitted data. <ul style="list-style-type: none"> ▶ "Check digit verification" must be enabled. 	No
Select Length	<ul style="list-style-type: none"> ▶ One or two fixed lengths ▶ Range (1~55) 	4~55
Codabar		Enable
CLSI editing	When applied, the CLSI editing strips the start/stop characters and inserts a space after the first, fifth, and tenth characters of a 14-character Codabar barcode. <ul style="list-style-type: none"> ▶ The 14-character barcode length does not include start/stop characters. 	No
NOTIS editing	Decide whether to include start/stop characters in the transmitted data. <ul style="list-style-type: none"> ▶ NOTIS Editing is to strip the start/stop characters, i.e. to disable "Transmit Start/Stop Characters". 	No
Select Length (min/max)	<ul style="list-style-type: none"> ▶ One or two fixed lengths ▶ Range (1~55) 	4~55
Code 128		Enable
GS1-128 (UCC/EAN-128)	Read GS1-128 barcodes with leading FNC1 character.	Enable
ISBT 128	Read ISBT 128 barcodes.	Enable
Industrial 25 (Discrete 25)		Enable
Select Length (min/max)	<ul style="list-style-type: none"> ▶ One or two fixed lengths ▶ Range (1~55) 	4~55
Interleaved 25		Enable

Convert to EAN-13	Convert a 14-character barcode into EAN-13 if the following requirements are met: <ul style="list-style-type: none"> ▶ The barcode must have a leading 0 and a valid EAN-13 check digit. ▶ "Check digit verification" must be disabled. 	No				
Check digit verification	Decide whether to verify the check digit. If desired, select one of the algorithms below. If the check digit is incorrect, the barcode will not be accepted. <ul style="list-style-type: none"> ▶ Disable ▶ USS check digit ▶ OPCC check digit 	Disable				
Transmit Check Digit	Decide whether to include the check digit in the data being transmitted.	No				
Select Length (min/max)	<ul style="list-style-type: none"> ▶ One or two fixed lengths ▶ Range (1~55) 	4~55				
Chinese 25		Enable				
Code 39		Enable				
Convert to Code 32	Convert to Italian Pharmacode.	No				
Code 32 Prefix	Prefix character "A" to Code 32 barcodes.	No				
Check digit verification	Decide whether to verify the check digit. If the check digit is incorrect, the barcode will not be accepted.	No				
Transmit Check Digit	Decide whether to include the check digit in the data being transmitted. <ul style="list-style-type: none"> ▶ "Check digit verification" must be enabled. 	No				
Code 39 Full ASCII	Code 39 Full ASCII includes all the alphanumeric and special characters.	No				
Trioptic Code 39	Decide whether to decode Trioptic Code 39. <ul style="list-style-type: none"> ▶ Trioptic Code 39 is a variant of Code 39 used in the marking of computer tape cartridges. It always contains six characters. 	No				
Select Length (min/max)	<ul style="list-style-type: none"> ▶ One or two fixed lengths ▶ Range (1~55) 	4~55				
Code 93		Enable				
Select Length (min/max)	<ul style="list-style-type: none"> ▶ One or two fixed lengths ▶ Range (1~55) 	4~55				
MSI		Enable				
Check digit verification	<p>If Two Check Digits option is selected, an additional verification is required to ensure integrity. Select one of the algorithms below. If the check digit is incorrect, the barcode will not be accepted.</p> <p>Check digit algorithm:</p> <table border="1" style="width: 100%; border-collapse: collapse;"> <tr> <td style="width: 50%;">One Check Digit</td> <td>Single Modulo 10</td> </tr> <tr> <td>Two Check Digits</td> <td> <ul style="list-style-type: none"> ▶ Mod 10/Mod 11 ▶ Mod 10/Mod 10 </td> </tr> </table>	One Check Digit	Single Modulo 10	Two Check Digits	<ul style="list-style-type: none"> ▶ Mod 10/Mod 11 ▶ Mod 10/Mod 10 	Single Modulo 10
One Check Digit	Single Modulo 10					
Two Check Digits	<ul style="list-style-type: none"> ▶ Mod 10/Mod 11 ▶ Mod 10/Mod 10 					

Transmit Check Digit	Decide whether to include the check digit in the data being transmitted.	No
Select Length (min/max)	<ul style="list-style-type: none"> ▶ One or two fixed lengths ▶ Range (1~55) 	4~55
GS1 DataBar (RSS)		---
GS1 Databar-14	GS1 DataBar-14 is short for GS1 DataBar Omnidirectional. This group consists of (1) GS1 DataBar Omnidirectional, (2) GS1 DataBar Truncated, (3) GS1 DataBar Stacked, and (4) GS1 DataBar Stacked Omnidirectional.	Enable
GS1 Databar Limited		Enable
GS1 Databar Expanded	This group consists of (1) GS1 DataBar Expanded, and (2) GS1 DataBar Expanded Stacked.	Enable
Convert RSS to UPC/EAN	<p>"Convert to UPC/EAN" only applies to GS1 Databar-14 and GS1 Databar Limited barcodes not decoded as part of a Composite barcode.</p> <div style="border: 1px solid black; padding: 5px;"> <p>Convert to EAN-13</p> <p>Strip the leading "010" from barcodes.</p> <ul style="list-style-type: none"> ▶ "01" is the Application ID and must be followed by a single zero (the first digit encoded) </div> <div style="border: 1px solid black; padding: 5px; margin-top: 5px;"> <p>Convert to UPC-A</p> <p>Strip the leading "0100" from barcodes.</p> <ul style="list-style-type: none"> ▶ "01" is the Application ID and must be followed by two or more zeros (but not six zeros) </div>	No
EAN/JAN		---
Enable EAN-8		Enable
Enable EAN-13		Enable
Bookland EAN (ISBN)	The EAN-13 barcode starting with 978 will be converted to ISBN.	Enable
Enable Addons	<p>Decide whether to decode EAN-8, EAN-13, UPC-E0, UPC-E1, UPC-A with addons.</p> <ul style="list-style-type: none"> ▶ Ignore Addons ▶ Decode Only With Addons ▶ Auto-discriminate 	Ignore...
Addons redundancy	When "Auto-discriminate" is applied, decide the number of times (2~30) of supplementary decoding the same barcode that makes a valid reading.	10 times
EAN-8 extend		No
UCC coupon extended code	<p>Read UPC-A barcodes starting with digit "5", EAN-13 barcodes starting with digits "99", and UPC-A/GS1-128 Coupon Codes.</p> <ul style="list-style-type: none"> ▶ UPC-A, EAN-13, and GS1-128 must be enabled first! ▶ Use "Addon Redundancy" to control auto-discrimination of the GS1-128 (right half) of a coupon code. 	No

UPC		---
UPC-A/UPC-E/UPC-E1	For the default value, the UPC-A and UPC-E are enabled.	
Enable Addons	Decide whether to decode EAN-8, EAN-13, UPC-E0, UPC-E1, UPC-A with addons. <ul style="list-style-type: none"> ▶ Ignore Addons ▶ Decode Only With Addons ▶ Auto-discriminate 	Ignore...
Addons redundancy	When "Auto-discriminate" is applied, decide the number of times (2~30) of supplementary decoding the same barcode that makes a valid reading.	10 times
Transmit Check Digit	Decide whether to include the UPC-A/UPC-E/UPC-E1 check digit in the data being transmitted.	Yes
Convert to UPC-A	The UPC-E0/UPC-E1 barcode will be expanded into UPC-A, and the next processing will follow the settings configured for UPC-A.	No
UCC coupon extended code	Read UPC-A barcodes starting with digit "5", EAN-13 barcodes starting with digits "99", and UPC-A/GS1-128 Coupon Codes. <ul style="list-style-type: none"> ▶ UPC-A, EAN-13, and GS1-128 must be enabled first! ▶ Use "Addon Redundancy" to control auto-discrimination of the GS1-128 (right half) of a coupon code. 	No
Transmit Preamble	Decide whether to include the UPC-A/UPC-E/UPC-E1 preamble System Character (and Country Code) in the data being transmitted.	System Character

MISCELLANEOUS

Laser Engine	Description	Default
Miscellaneous Options		---
Transmit Code ID	Decide whether to include AIM Code ID in the beginning of data. <ul style="list-style-type: none"> ▶ none ▶ AIM code ID character Each AIM Code ID contains the three-character string "]cm " - <ul style="list-style-type: none"> ▶] = Flag Character (ASCII 93) ▶ c = Code Character (see below) ▶ m = Modifier Character (see below) 	none

AIM CODE ID - CODE CHARACTERS

Code Character	Code Type
A	Code 39, Code 39 Full ASCII, Code 32
C	Code 128, Coupon (Code 128 portion)
d	Data Matrix

E	UPC/EAN, Coupon (UPC portion)
e	GS1 DataBar (RSS)
F	Codabar
G	Code 93
H	Code 11
I	Interleaved 25
L	PDF417, Macro PDF417, Micro PDF417
M	MSI
Q	QR Code
S	Industrial 25 (Discrete 25), IATA 2 of 5
U	Maxicode
X	Code 39 Trioptic, Bookland EAN, US Postnet, US Planet, UK Postal, Japan Postal, Australian Postal, Dutch Postal

AIM CODE ID - MODIFIER CHARACTERS

Code Type	Option Value	Option
Code 39	0	No check character or Full ASCII processing.
	1	Check digit has been verified.
	3	Check digit has been verified and stripped.
	4	Full ASCII conversion has been performed.
	5	Result of option values 1 and 4.
	7	Result of option values 3 and 4.
Code 128	0	Standard data packet. No Function Code 1“FNC1” in the first character position.
	1	Function Code 1“FNC1” in the first character position.
	2	Function Code 1“FNC1” in the second character position.
Interleaved 25	0	No check digit processing.
	1	Check digit has been verified.
	3	Check digit has been verified and stripped.
Codabar	0	No check digit processing.
Code 93	0	Always transmit 0.
MSI	0	Modulo 10 check digit verified and transmitted.
	1	Modulo 10 check digit verified but not transmitted.
Industrial 25 (Discrete 25)	0	Always transmit 0.
UPC/EAN	0	Standard data packet in full EAN country code format, which is 13 digits for UPC-A and UPC-E (not including addons).
	3	Standard data packet with two-digit or five-digit addons.

	4	EAN-8 data packet. A UPC-A with Addon 2 barcode, 012345678905-10, is transmitted to the host as a 18-character string, 1€3001234567890510.
Bookland EAN	0	Always transmit 0.
Trioptic Code 39	0	Always transmit 0.
Code 11	0	Single check digit (has been verified.)
	1	Two check digits (has been verified.)
	3	Check digit has been verified but not transmitted.
GS1 DataBar (RSS)	0	Always transmit 0.
		RSS-14 and RSS Limited will be transmitted with an Application Identifier "01". For example, an RSS-14 barcode, 10012345678902, is transmitted as 1€00110012345678902.

Note: In GS1-128 emulation mode, RSS is transmitted using Code 128 rules (= "JC1").

EAN.UCC Composites (RSS, GS1-128, 2D portion of UPC composite)	Native mode transmission	
	0	Standard data packet
	1	Data packet containing the data following an encoded symbol separator character.
	2	Data packet containing the data following an escape mechanism character. The data packet does not support the ECI protocol.
	3	Data packet containing the data following an escape mechanism character. The data packet supports the ECI protocol.
	GS1-128 emulation	
1	Data packet is a GS1-128 barcode (= data is preceded with "JC1").	

Note: UPC portion of composite is transmitted using UPC rules.

PDF417, Micro PDF417	0	Scan engine is set to conform to protocol defined in 1994 PDF417 symbology specifications. ▶ When this option is transmitted, the receiver cannot reliably determine whether ECIs have been invoked or whether data byte 92 _{DEC} has been doubled in transmission.
	1	Scan engine is set to follow the ECI protocol (Extended Channel Interpretation). All data characters 92 _{DEC} are doubled.
	2	Scan engine is set for Basic Channel operation (no escape character transmission protocol). Data characters 92 _{DEC} are not doubled. ▶ When decoders are set to this mode, unbuffered Macro symbols and symbols requiring the decoder to convey ECI escape sequences cannot be transmitted.

	3	The barcode contains a GS1-128 symbol, and the first codeword is 903-907, 912, 914, 915.
	4	The barcode contains a GS1-128 symbol, and the first codeword is in the range 908-909.
	5	The barcode contains a GS1-128 symbol, and the first codeword is in the range 910-911.
	A PDF417 barcode, ABCD, with no transmission protocol enabled, is transmitted as]L2ABCD.	
Data Matrix	0	ECC 000-140, not supported.
	1	ECC 200.
	2	ECC 200, FNC1 in first or fifth position.
	3	ECC 200, FNC1 in second or sixth position.
	4	ECC 200, ECI protocol implemented.
	5	ECC 200, FNC1 in first or fifth position, ECI protocol implemented.
	6	ECC 200, FNC1 in second or sixth position, ECI protocol implemented.

Maxicode	0	Mode 4 or 5
	1	Mode 2 or 3
	2	Mode 4 or 5, ECI protocol implemented.
	3	Mode 2 or 3, ECI protocol implemented in secondary message.
QR Code	0	Model 1
	1	Model 2, ECI protocol not implemented.
	2	Model 2, ECI protocol implemented.
	3	Model 2, ECI protocol not implemented, FNC1 implied in first position.
	4	Model 2, ECI protocol implemented, FNC1 implied in first position.
	5	Model 2, ECI protocol not implemented, FNC1 implied in second position.
	6	Model 2, ECI protocol implemented, FNC1 implied in second position

Note: For JPEG files, these BPP settings are ignored for it always uses 8 bits per pixel!

2D IMAGER (SE4500DL)

The tables below list the symbology settings for 2D imager (SE4500DL).

SYMBOLGY SETTINGS

1D SYMBOLOGIES

2D Engine	Description	Default
Codabar		Enable
CLSI Editing	When applied, the CLSI editing strips the start/stop characters and inserts a space after the first, fifth, and tenth characters of a 14-character Codabar barcode. <ul style="list-style-type: none"> ▶ The 14-character barcode length does not include start/stop characters. 	No
NOTIS Editing	Decide whether to include the start/stop characters in the data being transmitted. <ul style="list-style-type: none"> ▶ NOTIS Editing is to strip the start/stop characters, which equals to "Disable Transmit Start/Stop Characters". 	No
Select Length	<ul style="list-style-type: none"> ▶ One or two fixed lengths ▶ Range (1~55) 	4~55
Intercharacter Gap Size	The Code 39 and Codabar symbologies have an intercharacter gap that is typically quite small. Due to various barcode printing technologies, this gap can grow larger than the maximum size allowed, preventing the scan engine from decoding a barcode. If this problem occurs, set it to "Large Intercharacter Gaps" to tolerate these out-of-specification barcodes. <ul style="list-style-type: none"> ▶ Normal intercharacter gaps ▶ Large intercharacter gaps 	Normal
Code 128		---
Code 128	Read standard Code 128 barcodes (= without leading FNC1 character).	Enable
GS1-128 (UCC/EAN-128)	Read GS1-128 barcodes with leading FNC1 character.	Enable
ISBT 128	Read ISBT 128 barcodes.	Enable
ISBT Concatenation	Decide whether to decode and concatenate pairs of ISBT barcodes. <ul style="list-style-type: none"> ▶ Disable ▶ Enable – When this option is selected, there must be two ISBT barcodes for the reader to decode and perform concatenation. ▶ Auto-discriminate – When this option is selected, the reader decodes and concatenates pairs of ISBT barcodes 	Disable

	immediately. If only a single ISBT barcode is present, the reader must decode 10 times before transmitting its data to confirm that there is no additional ISBT barcode.	
ISBT Concatenation Redundancy	When "Auto-discriminate" is applied, decide the concatenation redundancy (2~20 times).	10 times
Industrial 25 (Discrete 25)		Enable
Select Length	<ul style="list-style-type: none"> ▶ One or two fixed lengths ▶ Range (1~55) 	4~55
Interleaved 25		Enable
Convert to EAN-13	Convert a 14-character barcode into EAN-13 if the following requirements are met: <ul style="list-style-type: none"> ▶ The barcode must have a leading 0 and a valid EAN-13 check digit. ▶ "Verify Check Digit" must be disabled. 	No
Verify Check Digit	Decide whether to verify the check digit. If desired, select one of the algorithms below. If the check digit is incorrect, the barcode will not be accepted. <ul style="list-style-type: none"> ▶ No ▶ USS algorithm ▶ OPCC algorithm 	No
Transmit Check Digit	Decide whether to include the check digit in the data being transmitted.	No
Select Length	<ul style="list-style-type: none"> ▶ One or two fixed lengths ▶ Range (1~55) 	4~55
Matrix 25		Enable
Redundancy	Decide whether to enable decode redundancy.	Disable
Verify Check Digit	Decide whether to verify the check digit. If the check digit is incorrect, the barcode will not be accepted.	No
Transmit Check Digit	Decide whether to include the check digit in the data being transmitted.	No
Select Length	<ul style="list-style-type: none"> ▶ One or two fixed lengths ▶ Range (1~55) 	4~55
Chinese 25		Enable
Code 39		Enable
Convert to Code 32	Convert to Italian Pharmacode.	No
Code 32 Prefix	Prefix character "A" to Code 32 barcodes.	No
Verify Check Digit	Decide whether to verify the check digit. If the check digit is incorrect, the barcode will not be accepted.	No
Transmit Check Digit	Decide whether to include the check digit in the data being transmitted. <ul style="list-style-type: none"> ▶ "Verify Check Digit" must be enabled. 	No
Code 39 Full ASCII	Code 39 Full ASCII includes all the alphanumeric and special characters.	Disable

Trioptic Code 39	Decide whether to decode Trioptic Code 39. ▶ Trioptic Code 39 is a variant of Code 39 used in the marking of computer tape cartridges. It always contains six characters.	Disable						
Select Length	▶ One or two fixed lengths ▶ Range (1~55)	4~55						
Intercharacter Gap Size	The Code 39 and Codabar symbologies have an intercharacter gap that is typically quite small. Due to various barcode printing technologies, this gap can grow larger than the maximum size allowed, preventing the scan engine from decoding a barcode. If this problem occurs, set it to "Large Intercharacter Gaps" to tolerate these out-of-specification barcodes. ▶ Normal intercharacter gaps ▶ Large intercharacter gaps	Normal						
Code 93		Enable						
Select Length	▶ One or two fixed lengths ▶ Range (1~55)	4~55						
MSI		Enable						
Verify Check Digit	If Two Check Digits option is selected, an additional verification is required to ensure integrity. Select one of the algorithms below. If the check digit is incorrect, the barcode will not be accepted. <table border="1" data-bbox="491 1055 1198 1249"> <thead> <tr> <th>Check Digit</th> <th>Algorithm</th> </tr> </thead> <tbody> <tr> <td>One Check Digit</td> <td>Single Modulo 10</td> </tr> <tr> <td>Two Check Digits</td> <td>▶ Mod 10/Mod 11 ▶ Mod 10/Mod 10</td> </tr> </tbody> </table>	Check Digit	Algorithm	One Check Digit	Single Modulo 10	Two Check Digits	▶ Mod 10/Mod 11 ▶ Mod 10/Mod 10	Single Modulo 10
Check Digit	Algorithm							
One Check Digit	Single Modulo 10							
Two Check Digits	▶ Mod 10/Mod 11 ▶ Mod 10/Mod 10							
Transmit Check Digit	Decide whether to include the check digit in the data being transmitted.	No						
Select Length	▶ One or two fixed lengths ▶ Range (1~55)	4~55						
GS1 DataBar (RSS)		---						
GS1 Databar-14	GS1 DataBar-14 is short for GS1 DataBar Omnidirectional. This group consists of (1) GS1 DataBar Omnidirectional, (2) GS1 DataBar Truncated, (3) GS1 DataBar Stacked, and (4) GS1 DataBar Stacked Omnidirectional.	Enable						
GS1 Databar Limited		Enable						
GS1 Databar Expanded	This group consists of (1) GS1 DataBar Expanded, and (2) GS1 DataBar Expanded Stacked.	Enable						

Convert RSS to UPC/EAN	"Convert to UPC/EAN" only applies to GS1 Databar-14 and GS1 Databar Limited barcodes not decoded as part of a Composite barcode. Convert to EAN-13 Strip the leading "010" from barcodes. ▶ "01" is the Application ID and must be followed by a single zero (the first digit encoded) Convert to UPC-A Strip the leading "0100" from barcodes. ▶ "01" is the Application ID and must be followed by two or more zeros (but not six zeros)	No
EAN-8		Enable
Convert to EAN-13	The EAN-8 barcode will be expanded into EAN-13, and the next processing will follow the settings configured for EAN-13.	No
Addon 2 / Addon 5	Refer to UPC/EAN Addon setting.	
EAN-13		Enable
Bookland EAN (ISBN)	The EAN-13 barcode starting with 978 will be converted to ISBN.	Yes
Addon 2 / Addon 5	Refer to UPC/EAN Addon setting.	
UPC-A		Enable
Transmit Check Digit	Decide whether to include the UPC-A check digit in the data being transmitted.	Yes
Transmit Preamble	Decide whether to include the UPC-A preamble System Number (and Country Code) in the data being transmitted.	System Number
Addon 2 / Addon 5	Refer to UPC/EAN Addon setting.	
UPC-E0		Enable
Transmit Check Digit	Decide whether to include the UPC-E0 check digit in the data being transmitted.	Yes
Transmit Preamble	Decide whether to include the UPC-E0 preamble System Number (and Country Code) in the data being transmitted.	System Number
Addon 2 / Addon 5	Refer to UPC/EAN Addon setting.	
Convert to UPC-A	The UPC-E0 barcode will be expanded into UPC-A, and the next processing will follow the settings configured for UPC-A.	No
UPC-E1		Disable
Transmit Check Digit	Decide whether to include the UPC-E1 check digit in the data being transmitted.	Yes
Transmit Preamble	Decide whether to include the UPC-E1 preamble System Number (and Country Code) in the data being transmitted.	System Number
Addon 2 / Addon 5	Refer to UPC/EAN Addon setting.	
Convert to UPC-A	The UPC-E1 barcode will be expanded into UPC-A, and the next processing will follow the settings configured for UPC-A.	No

UCC Coupon Extended Code		Disable
Read UPC-A barcodes starting with digit "5", EAN-13 barcodes starting with digits "99", and UPC-A/GS1-128 Coupon Codes. <ul style="list-style-type: none"> ▶ UPC-A, EAN-13, and GS1-128 must be enabled first! ▶ Use "Addon Redundancy" to control auto-discrimination of the GS1-128 (right half) of a coupon code. 		
UPC/EAN Addon		---
Addon 2 / Addon 5	Decide whether to decode EAN-8, EAN-13, UPC-E0, UPC-E1, UPC-A with addons. <ul style="list-style-type: none"> ▶ Ignore Addons ▶ Decode Only With Addons ▶ Auto-discriminate 	Ignore...
Addon Redundancy	When "Auto-discriminate" is applied, decide the number of times of supplementary decoding for the same barcode to make a valid reading.	10 times
Code 11		Enable
Verify Check Digit	Decide whether to verify the check digit. If the check digit is incorrect, the barcode will not be accepted. <ul style="list-style-type: none"> ▶ No verification ▶ One Check Digit ▶ Two Check Digits 	No
Transmit Check Digit	Decide whether to include the check digit in the data being transmitted. <ul style="list-style-type: none"> ▶ "Verify Check Digit" must be enabled. 	No
Select Length	<ul style="list-style-type: none"> ▶ One or two fixed lengths ▶ Range (1~55) 	4~55
Postal Codes		---
US Postnet		Enable
US Planet		Enable
Transmit US Postal Check Digit	US Postnet or US Planet must be enabled first!	Enable
UK Postal		Enable
Transmit UK Postal Check Digit	UK Postal must be enabled first!	Enable
Japan Postal		Enable
Australian Postal		Enable
Dutch Postal		Enable
Composite Codes		---
Composite CC-C		Enable
Composite CC-A/B		Disable
Composite TLC-39		Disable

<p>GS1-128 Emulation Mode for UCC/EAN Composite Codes</p>	<p>Transmit UCC/EAN Composite Code data as if it was encoded in GS1-128 barcodes.</p>	<p>Disable</p>
<p>UPC Composite Mode</p>	<p>UPC barcodes can be "linked" with a 2D barcode during transmission as if they were one barcode.</p> <hr/> <p>UPC Never Linked</p> <p>Transmit UPC barcodes regardless of whether a 2D barcode is detected.</p> <hr/> <p>UPC Always Linked</p> <p>Transmit UPC barcodes and the 2D portion. If the 2D portion is not detected, the UPC barcode will not be transmitted.</p> <ul style="list-style-type: none"> ▶ CC-A/B or CC-C must be enabled! <hr/> <p>Auto-discriminate UPC Composites</p> <p>Transmit UPC barcodes as well as the 2D portion if present.</p>	<p>UPC Always Linked</p>

2D SYMBOLOGIES

2D Engine	Description	Default			
2D Symbologies		---			
PDF417		Enable			
MicroPDF417		Disable			
MicroPDF417 Code 128 Emulation	<p>Transmit data from certain MicroPDF417 barcodes as if it was encoded in Code 128 barcodes.</p> <p>▶ Transmit AIM Code Identifier in Miscellaneous Options must be enabled first!</p> <p>When applied, the MicroPDF417 barcodes are transmitted with one of these prefixes:</p> <table border="1"> <tr> <td> <p>The first codeword of MicroPDF417 is 903-907, 912, 914, 915:</p> <p>The original Code ID "]L3" will be changed to "]C1".</p> </td> </tr> <tr> <td> <p>The first codeword of MicroPDF417 is 908 or 909:</p> <p>The original Code ID "]L4" will be changed to "]C2".</p> </td> </tr> <tr> <td> <p>The first codeword of MicroPDF417 is 910 or 911:</p> <p>The original Code ID "]L5" will be changed to "]C0".</p> </td> </tr> </table>	<p>The first codeword of MicroPDF417 is 903-907, 912, 914, 915:</p> <p>The original Code ID "]L3" will be changed to "]C1".</p>	<p>The first codeword of MicroPDF417 is 908 or 909:</p> <p>The original Code ID "]L4" will be changed to "]C2".</p>	<p>The first codeword of MicroPDF417 is 910 or 911:</p> <p>The original Code ID "]L5" will be changed to "]C0".</p>	Disable
<p>The first codeword of MicroPDF417 is 903-907, 912, 914, 915:</p> <p>The original Code ID "]L3" will be changed to "]C1".</p>					
<p>The first codeword of MicroPDF417 is 908 or 909:</p> <p>The original Code ID "]L4" will be changed to "]C2".</p>					
<p>The first codeword of MicroPDF417 is 910 or 911:</p> <p>The original Code ID "]L5" will be changed to "]C0".</p>					
Data Matrix		Enable			
Data Matrix Inverse	<p>Decide whether to decode Data Matrix Inverse.</p> <table border="1"> <tr> <td> <p>Regular Only</p> <p>Decode regular Data Matrix barcodes only.</p> </td> </tr> <tr> <td> <p>Inverse Only</p> <p>Decode inverse Data Matrix barcodes only.</p> </td> </tr> <tr> <td> <p>Autodetect</p> <p>Decode both regular and inverse Data Matrix barcodes.</p> </td> </tr> </table>	<p>Regular Only</p> <p>Decode regular Data Matrix barcodes only.</p>	<p>Inverse Only</p> <p>Decode inverse Data Matrix barcodes only.</p>	<p>Autodetect</p> <p>Decode both regular and inverse Data Matrix barcodes.</p>	Regular Only
<p>Regular Only</p> <p>Decode regular Data Matrix barcodes only.</p>					
<p>Inverse Only</p> <p>Decode inverse Data Matrix barcodes only.</p>					
<p>Autodetect</p> <p>Decode both regular and inverse Data Matrix barcodes.</p>					
Maxicode		Enable			
QR Code		Enable			
QR Code Inverse	<p>Decide whether to decode QR Code Inverse.</p> <table border="1"> <tr> <td> <p>Regular Only</p> <p>Decode regular QR Code only.</p> </td> </tr> <tr> <td> <p>Inverse Only</p> <p>Decode inverse QR Code only.</p> </td> </tr> </table>	<p>Regular Only</p> <p>Decode regular QR Code only.</p>	<p>Inverse Only</p> <p>Decode inverse QR Code only.</p>	Regular Only	
<p>Regular Only</p> <p>Decode regular QR Code only.</p>					
<p>Inverse Only</p> <p>Decode inverse QR Code only.</p>					

	<p>Autodetect</p> <p>Decode both regular and inverse QR Code.</p>	
MicroQR		Enable
Aztec		Enable
Aztec Inverse	<p>Decide whether to decode Aztec Inverse.</p> <p>Regular Only</p> <p>Decode regular Aztec barcodes only.</p> <p>Inverse Only</p> <p>Decode inverse Aztec barcodes only.</p> <p>Autodetect</p> <p>Decode both regular and inverse Aztec barcodes.</p>	Regular Only
2D Symbologies - Macro PDF		---
<p>Macro PDF is a special feature for concatenating multiple PDF barcodes into one file, known as Macro PDF417 or Macro MicroPDF417.</p>		
Transmit/Decode Mode	<p>Decide how to handle Macro PDF decoding.</p> <p>Buffer All Symbols / Transmit Macro PDF When Complete</p> <p>Transmit all decoded data from an entire Macro PDF sequence only when the entire sequence is scanned and decoded. If the decoded data exceeds the limit of 50 symbols, no transmission because the entire sequence was not scanned!</p> <p>Transmit Any Symbol in Set / No Particular Order</p> <p>Transmit data from each Macro PDF symbol as decoded, regardless of the sequence.</p> <p>Passthrough All Symbols</p> <p>Transmit and decode all Macro PDF symbols and perform no processing. In this mode, the host is responsible for detecting and parsing the Macro PDF sequences.</p>	Passthrough All Symbols
ESC Characters	<p>When enabled, it uses the backslash "\" as an Escape character for systems that can process transmissions containing special data sequences. It will format special data according to the Global Label Identifier (GLI) protocol, which only affects the data portion of a Macro PDF symbol transmission. The Control Header, if enabled, is always sent with GLI formatting.</p>	None

Note: When printing barcodes, keep each Macro PDF sequence separate, as each has a unique identifier. Do not mix barcodes from several Macro PDF sequences, even if they encode the same data. When you scan Macro PDF sequences, scan the entire Macro PDF sequence without interruption!

MISCELLANEOUS

2D Engine	Description	Default
Miscellaneous Options		---
Transmit Code ID character	Decide whether to include AIM Code ID in the beginning of data. <ul style="list-style-type: none"> ▶ None ▶ AIM code ID character (Refer to AIM Code ID - Code Characters) 	none

HF RFID READER

HF RFID reader supports ISO14443A and B, 15693 and Secure Access Module (SAM).

RFID TAG DEFAULT BLOCK

Tag Type	Standard	Default Block/Page
Mifare	ISO 14443A	4
SR176	ISO 14443B	4
ICODE SLI	ISO 15693	3
LRI512	ISO 15693	0
SRF55VxxP	ISO 15693	3
EM4135	ISO 15693	0
Tag-it HF-I	ISO 15693	0
Others	ISO 15693	0
ICODE	ICODE® (Phillips)	5
Tag-it	Tag-it® (TI)	0

PHYSICAL KEYPAD REFERENCE TABLE

NUMERIC KEYPAD

Numeric keypad layout:

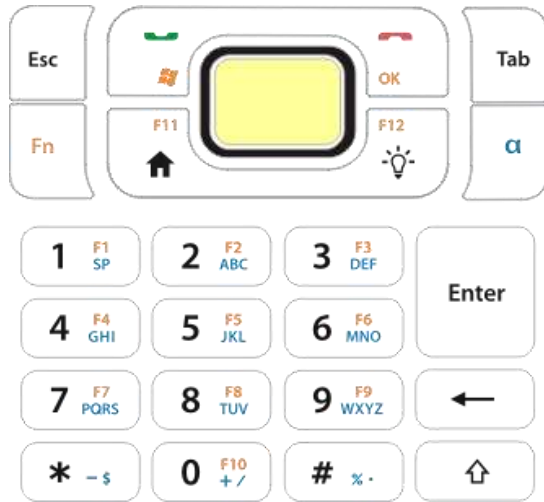

USE ALPHA (α), SHIFT (⇧) & FN KEYS

Key	[α] keystroke beforehand	[α] + [⇧] keystrokes beforehand	Key	[⇧] keystroke beforehand	Key	[Fn] keystroke beforehand
1	a blank space	a blank space	1	!	1	F1
2	abc	ABC	2	@	2	F2
3	def	DEF	3	#	3	F3
4	ghi	GHI	4	\$	4	F4
5	jkl	JKL	5	%	5	F5
6	mno	MNO	6	^	6	F6
7	pqrs	PQRS	7	&	7	F7
8	tuv	TUV	8	*	8	F8
9	wxyz	WXYZ	9	(9	F9
0	+ /	+ /	0)	0	F10
*	- \$	- \$	*	null	*	null
#	% .	% .	#	null	#	null
					⇧	F11

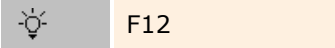



QWERTY KEYPAD

QWERTY keypad layout:



USE ALPHA (A), SHIFT (⇧) & FN KEYS

Key	[⇧] keystroke beforehand	[⇧] keystrokes twice beforehand	[α] keystroke beforehand	[Fn] keystroke beforehand
q	Q	Q	#	--
w	W	W	1	F1
e	E	E	2	F2
r	R	R	3	F3
t	T	T	(--
y	Y	Y)	--
u	U	U	/	--
i	I	I	*	--
o	O	O	-	--
p	P	P	+	--
a	A	A	!	--
s	S	S	4	F4
d	D	D	5	F5
f	F	F	6	F6
g	G	G	<	--
h	H	H	>	--
j	J	J	\	--
k	K	K	^	--

l	L	L	%	--
\$	\$	\$	=	--
z	Z	Z	7	F7
x	X	X	8	F8
c	C	C	9	F9
v	V	V	?	--
b	B	B	:	--
n	N	N	;	--
m	M	M	,	--
@	@	@	.	--
_	_	_	"	--
&	&	&	0	F10
				F11
				F12